

ASSESSMENT OF DAM SAFETY OF COAL COMBUSTION SURFACE IMPOUNDMENTS FINAL REPORT



**CPS Energy
J.K. Spruce Power Plant
San Antonio, Texas**

Prepared for
*U.S. Environmental
Protection Agency
Washington, D.C.*

February 2014
Revised May 2014
Revised June 2014

CDM Smith Project No.:
93083.1801.044.SIT.SPRCE

**CDM
Smith**

Table of Contents

Section 1 Introduction, Summary Conclusions and Recommendations	1-1
1.1 Introduction	1-1
1.2 Purpose and Scope	1-1
1.3 Conclusions and Recommendations.....	1-2
1.3.1 Conclusions.....	1-2
1.3.1.1 Conclusions Regarding Structural Soundness of the CCW Impoundments.....	1-2
1.3.1.2 Conclusions Regarding the Hydrologic/Hydraulic Safety of CCW Impoundments.....	1-3
1.3.1.3 Conclusions Regarding Adequacy of Supporting Technical Documentation.....	1-3
1.3.1.4 Conclusions Regarding Description of the CCW Impoundments.....	1-3
1.3.1.5 Conclusions Regarding Field Observations	1-3
1.3.1.6 Conclusions Regarding Adequacy of Maintenance and Methods of Operation.....	1-3
1.3.1.7 Conclusions Regarding Adequacy of Surveillance and Monitoring Program	1-3
1.3.1.8 Conclusions Regarding Suitability for Continued Safe and Reliable Operation.....	1-3
1.3.2 Recommendations.....	1-3
1.3.2.1 Recommendations Regarding the Hydrologic/Hydraulic Safety	1-4
1.3.2.2 Recommendations Regarding the Technical Documentation for Structural Stability	1-4
1.3.2.3 Recommendations Regarding Field Observations.....	1-4
1.3.2.4 Recommendations Regarding Adequacy of Maintenance and Methods of Operation.....	1-4
1.3.2.5 Recommendations Regarding Surveillance and Monitoring Program.....	1-4
1.3.2.6 Recommendations Regarding Continued Safe and Reliable Operation.....	1-4
1.4 Participants and Acknowledgment.....	1-4
1.4.1 List of Participants.....	1-4
1.4.2 Acknowledgment and Signature	1-4
Section 2 Description of the Coal Combustion Waste (CCW) Impoundment(s)	2-1
2.1 Location and General Description	2-1
2.1.1 Horizontal and Vertical Datum	2-2
2.1.2 Site Geology	2-2
2.2 Coal Combustion Residue Handling.....	2-2
2.3 Size and Hazard Classification	2-3
2.4 Amount and Type of Residuals Currently Contained in the Unit(s) and Maximum Capacity.....	2-4
2.5 Principal Project Structures.....	2-4
2.6 Critical Infrastructure within Five Miles Down Gradient.....	2-5
Section 3 Summary of Relevant Reports, Permits and Incidents	3-1

3.1 Summary of Reports on the Safety of the Management Units.....	3-1
3.2 Summary of Local, State, and Federal Environment Permits	3-1
3.3 Summary of Spill/Release Incidents	3-1
Section 4 Summary of History of Construction and Operation	4-1
4.1 Summary of Construction History.....	4-1
4.1.1 Impoundment Construction and Historical Information.....	4-1
4.1.2 Significant Changes/Modifications in Design since Original Construction.....	4-1
4.1.3 Significant Repairs/Rehabilitation since Original Construction.....	4-2
4.2 Summary of Operational Procedures.....	4-2
4.2.1 Original Operating Procedures	4-2
4.2.2 Significant Changes in Operational Procedures and Original Startup.....	4-2
4.2.3 Current CCW Impoundment Configuration.....	4-2
4.2.4 Other Notable Events since Original Startup	4-2
Section 5 Field Observations.....	5-1
5.1 Project Overview and Significant Findings (Visual Observations).....	5-1
5.2 SRH Pond.....	5-2
5.2.1 Crest.....	5-2
5.2.2 Interior Slopes.....	5-2
5.2.3 Exterior Slopes	5-2
5.2.4 Inlet Piping.....	5-2
5.2.5 Outlet Structures	5-3
5.3 Evaporation Pond.....	5-3
5.3.1 Crest.....	5-3
5.3.2 Interior Slopes.....	5-3
5.3.3 Exterior Slopes	5-3
Section 6 Hydrologic/Hydraulic Safety	6-1
6.1 Impoundment Hydraulic Analysis.....	6-1
6.2 Adequacy of Supporting Technical Documentation	6-2
6.3 Assessment of Hydrologic/Hydraulic Safety	6-2
Section 7 Structural Stability	7-1
7.1 Supporting Technical Documentation.....	7-1
7.1.1 Stability Analyses and Load Cases Analyzed.....	7-1
7.1.2 Design Parameters and Dam Materials	7-2
7.1.3 Uplift and/or Phreatic Surface Assumptions	7-3
7.1.4 Factors of Safety and Base Stresses	7-3
7.1.5 Liquefaction Potential.....	7-4
7.1.6 Critical Geological Conditions.....	7-4
7.2 Adequacy of Supporting Technical Documentation	7-4
7.3 Assessment of Structural Stability.....	7-5
Section 8 Adequacy of Maintenance and Methods of Operation.....	8-1
8.1 Operating Procedures.....	8-1
8.2 Maintenance of the Dam and Project Facilities.....	8-1
8.3 Assessment of Maintenance and Methods of Operations.....	8-1
8.3.1 Adequacy of Operating Procedures.....	8-1
8.3.2 Adequacy of Maintenance	8-1

Section 9 Adequacy of Surveillance and Monitoring Program	9-1
9.1 Surveillance Procedures	9-1
9.2 Instrumentation Monitoring.....	9-1
9.3 Assessment of Surveillance and Monitoring Program.....	9-1
9.3.1 Adequacy of Inspection Programs.....	9-1
9.3.2 Adequacy of Instrumentation Monitoring Program	9-1
Section 10 Reports and References	10-1

Appendices

- Appendix A – RKCI Geotechnical Engineering Study
- Appendix B – USEPA Checklists
- Appendix C – Documentation from CPS
- Appendix D – Photographs

Tables

Table 2-1 – Summary of Impoundments Approximate Dimension and Size.....	2-2
Table 2-2 – USACE ER 1110-2-106 Size Classification.....	2-3
Table 2-3 – Recommended Impoundment Hazard Classification Ratings	2-3
Table 4-1 – Approximate Crest Elevations and Surface Areas	4-3
Table 5-1 – Approximate Precipitation Prior to Site Visit.....	5-1
Table 7-1 – Recommended Minimum Safety Factors.....	7-1
Table 7-2 – Soil Parameters Used in RKCI’s Steady-State Slope Stability Analyses	7-2
Table 7-3 – Soil Parameters Used in RKCI’s Seismic Slope Stability Analyses.....	7-3
Table 7-4 – Safety Factors Computed for Various Stability Conditions.....	7-3

Figures

- Figure 2-1 – Vicinity Map
- Figure 2-2 – Critical Infrastructure Plan
- Figure 2-3– Site Plan
- Figure 5-1 – SRH Pond
- Figure 5-2 – Evaporation Pond

Section 1

Introduction, Summary Conclusions and Recommendations

1.1 Introduction

On December 22, 2008, the dike of a coal combustion waste (CCW) ash pond dredging cell failed at a facility owned by the Tennessee Valley Authority in Kingston, Tennessee. The failure resulted in a spill of over one billion gallons of coal ash slurry, which covered more than 300 acres, damaging infrastructure and homes. In light of the dike failure, the United States Environmental Protection Agency (USEPA) is assessing the stability and functionality of existing CCW impoundments at coal-fired electric utilities to ensure that lives and property are protected from the consequences of a failure.

This assessment of the stability and functionality of the CPS Energy J.K. Spruce Power Plant ash CCW impoundments is based on a review of available documents, site assessments conducted by CDM Smith on August 27 and 28, 2012, and technical information provided subsequent to the site visit. In summary, the Sludge Recycle Holding (SRH) Pond's and Evaporation Pond's embankments are classified as **SATISFACTORY** based on static and seismic engineering studies following the best professional engineering practice to support acceptable safety factors under normal loading conditions (static, hydrologic, seismic) in accordance with the applicable safety regulatory criteria.

It is critical to note that the condition of the embankment(s) depends on numerous and constantly changing internal and external conditions, and is evolutionary in nature. It would be incorrect to assume that the present condition of the embankment(s) will continue to represent the condition of the embankment(s) at some point in the future. Only through continued care and inspection can there be likely detection of unsafe conditions.

1.2 Purpose and Scope

CDM Smith was contracted by the USEPA to perform site assessments of selected surface impoundments. As part of this contract, CDM Smith conducted site assessments of the SRH Pond and Evaporation Pond at the J.K. Spruce Power Plant (Plant) site owned by CPS Energy (CPS). These ponds are located on the east and north sides of the site. The purpose of this report is to provide the results of the assessments and evaluations of the conditions, and potential for waste release from the CCW impoundments

Site visits were conducted by CDM Smith representatives on August 27 and 28, 2012 to collect relevant information, inventory the impoundments, and perform visual assessments of the impoundments.

1.3 Conclusions and Recommendations

1.3.1 Conclusions

Conclusions are based on visual observations during site assessments on August 27 and 28, 2012 and review of technical documentation provided by CPS.

1.3.1.1 Conclusions Regarding Structural Soundness of the CCW Impoundments

A May 7, 2014 geotechnical report, prepared by Raba Kistner Consultants, Inc. (RKCI), was provided that included slope stability analyses for steady-state and seismic loading conditions of the SRH Pond and Evaporation Pond embankments. The RKCI 2014 report supersedes RKCI's November 12, 2012 report referenced in the CDM Smith's December 2012 "Assessment of Dam Safety of Coal Combustion Surface Impoundments, CPS Energy, J.K. Spruce Power Plant". The RKCI report is included in **Appendix A**. The calculated factors of safety presented in the RKCI 2014 report, for the loading conditions analyzed, met minimum required factors of safety outlined by the USACE in EM 1110-2-1902, Table 3-1 and seismic factors of safety by FEMA Federal Guidelines for Dam Safety, Earthquake Analyses and Design of Dams. The RKCI 2014 report did not present analyses for liquefaction potential, end-of-construction, and rapid drawdown loading conditions. RKCI stated in the 2014 report that the end-of-construction condition was not evaluated due to the age of the ash ponds. RKCI also stated that both rapid drawdown and erosion failures are considered to be of very low risk due to the embankment toe elevations (above EL 490 feet) with respect to the target pool elevation (EL 485 feet) and because they would pose no risk of environmental contamination, because the pond must empty for this condition to occur.

RKCI indicated in their May 2014 report that the soils beneath the existing berms have a very low risk of experiencing liquefaction due to earthquake. In their seismic slope stability analyses, RKCI used the mapped spectral response acceleration of 0.098g from the USGS web site calculator. RKCI further indicated in their 2014 report that the applied horizontal seismic load had a 4-to-6 % probability of exceedance in 50 years. USEPA guidelines specify that the mapped spectral response acceleration for an earthquake with 2% probability of exceedance in 50 years be used in seismic slope stability analyses. CDM Smith used USGS referenced maps, published in the 2010 ASCE-7 Standard, to determine the mapped spectral response acceleration for an earthquake with 2% probability of exceedance in 50 years. CDM Smith found the spectral response acceleration for the Spruce site to be 0.075g. Accordingly, in CDM Smith's opinion, the spectral response acceleration employed in RKCI's seismic analyses conforms to USEPA standards.

No apparent structural damage or evidence of previous repairs was observed in the CCW impoundments during CDM Smith's site visit. From visual observations, the embankments appeared structurally sound; however high water and solids level in Evaporation Pond prevented observation of the interior embankment slopes during CDM Smith's visual observations and site assessments.

CDM Smith agrees with RKCI's rationale regarding embankment stability for end-of-construction, liquefaction potential, and rapid drawdown conditions.

1.3.1.2 Conclusions Regarding the Hydrologic/Hydraulic Safety of CCW impoundments

Hydrologic/hydraulic (H & H) documentation provided by CPS included precipitation amounts for selected storm durations and return periods expected in the Calaveras Lake site area. A preliminary H & H evaluation performed by CDM Smith suggests there is enough storage capacity at current operating pool levels for the SRH Pond and the Evaporation Pond to safely store precipitation from the

FEMA recommended rainfall events (0.1-percent annual chance exceedance flood for the significant hazard potential SRH Pond and 1--percent annual chance exceedance flood for the low hazard potential Evaporation Pond). Based on CDM Smith's preliminary evaluation, the hydrologic/hydraulic safety of the impoundments appears to be adequate.

1.3.1.3 Conclusions Regarding Adequacy of Supporting Technical Documentation

CDM Smith has the following conclusions based on our review of the documentation provided by CPS:

- The RKCI documentation of the stability analyses for the SRH Pond and Evaporation Pond is considered adequate based on the following:
 - ✓ Steady-state and seismic stability analyses for of the SRH Pond and Evaporation Pond embankments are documented.
 - ✓ RKCI provided assessments of the embankments' liquefaction potential, and structural stability applicable for end of construction and sudden drawdown loading conditions. RKCI did not analyze liquefaction potential, end of construction and sudden drawdown loading conditions. As described above, CDM Smith agrees with RKCI's rationale for not performing analyses for these loading conditions.
- The hydrologic and hydraulic supporting documentation of SRH Pond and Evaporation Pond is considered inadequate based on the following:
 - ✓ H & H documentation provided by CPS included precipitation amounts for selected storm durations and return periods expected in the Calaveras Lake site area. No documentation was provided by CPS on the ability of the impoundments to store the FEMA-recommended design floods.
 - ✓ An evaluation to determine the required IDF and of the capacity of the SRH Pond and Evaporation Pond to withstand the design hydrologic/hydraulic events, without overtopping has not been provided.

1.3.1.4 Conclusions Regarding Description of the CCW impoundments

The record drawings and descriptions of the CCW impoundments provided by CPS representatives appear to be consistent with the visual observations by CDM Smith during site assessment.

1.3.1.5 Conclusions Regarding Field Observations

The exterior slopes of the Evaporation Pond are covered in grassy vegetation approximately 2 feet high and a few small trees and bushes with diameters less than 6 inches. Areas of loose soil were observed at the east embankment exterior slope of the Evaporation Pond and an animal burrow was observed at the west embankment exterior slope. Trees up to 12 inches in diameter were located at the toe of all embankments of the Evaporation Pond. Visible portions of interior slopes of the Evaporation Pond and SRH Pond did not include riprap or other armoring.

1.3.1.6 Conclusions Regarding Adequacy of Maintenance and Methods of Operation

Current maintenance and operation procedures appear to be generally adequate, though they are not documented. There was no existing evidence of previous spills or release of impounded liquids outside the plant property.

1.3.1.7 Conclusions Regarding Adequacy of Surveillance and Monitoring Program

No surveillance and monitoring procedures exist for the SRH Pond and Evaporation Pond. Instrumentation is not present for the SRH Pond or Evaporation Pond.

1.3.1.8 Conclusions Regarding Suitability for Continued Safe and Reliable Operation

Main embankments do not show evidence of unsafe conditions requiring immediate remedial efforts.

CPS' operating procedures for the SRH Pond include methods of controlling the water levels in the north and south sections of the SRH Pond, but no formal documentation was provided to CDM Smith. There were no documented operating procedures for the Evaporation Pond.

1.3.2 Recommendations

Based on CDM Smith's visual assessment of SRH Pond and Evaporation Pond and review of documentation provided by CPS, CDM Smith offers the following recommendations for consideration.

1.3.2.1 Recommendations Regarding the Hydrologic/Hydraulic Safety

It is recommended that a qualified professional engineer determine the required Inflow Design Flood (IDF) and evaluate the hydrologic and hydraulic capacity of the SRH Pond and Evaporation Pond to withstand design hydrologic/hydraulic events, without overtopping, as recommended by FEMA.

1.3.2.2 Recommendations Regarding the Technical Documentation for Structural Stability

None

1.3.2.3 Recommendations Regarding Field Observations

None; no significant deficiencies were observed at the SRH Pond and Evaporation Pond.

1.3.2.4 Recommendations Regarding Adequacy of Maintenance and Methods of Operation

CDM Smith recommends that vegetation on the SRH Pond and Evaporation Pond embankments be cut on a regular basis to help ensure that adequate visual observations can be made by CPS' personnel during routine inspections. CDM Smith also recommends trees (including the root ball) located at and within 15 feet of the toe of all embankments of the Evaporation Pond be removed and the excavations filled with compacted fill under the supervision of a qualified dam engineer. Animal control measures should be implemented to reduce embankment disturbance. All affected areas should be backfilled with compacted fill, graded to match the surrounding topography, and seeded with appropriate non-invasive grassy vegetation. It is also recommended that riprap be placed on interior embankment slopes in areas with little or no armoring.

1.3.2.5 Recommendations Regarding Surveillance and Monitoring Program

CPS Energy is required by Texas Commission on Environmental Quality (TCEQ) under National Pollutant Discharge Elimination System (NPDES) Permit No. WQ0001514000 to monitor discharge of wastewater into Calaveras Lake. Surveillance procedures should be in accordance with the TCEQ – NPDES Permit. According to CPS, no surveillance procedures exist for the SRH Pond and Evaporation Pond.

It is recommended that CPS prepare formal surveillance and monitoring procedures for the SRH and Evaporation Pond.

1.3.2.6 Recommendations Regarding Continued Safe and Reliable Operation

Inspections should be made following periods of heavy and/or prolonged rainfall, and the occurrence of these events should be documented. Inspection procedures should be documented and inspection records should be retained at the facility for a minimum of three years.

Major repairs and slope restoration should be designed by a registered professional engineer experienced with earthen dam design.

The above recommendations should be implemented to help maintain continued safe and reliable operation of the CCW impoundments.

1.4 Participants and Acknowledgment

1.4.1 List of Participants

CDM Smith representatives, Jamal Daas, P.E. and Bevin Barringer, P.E, were accompanied at all times during visual assessment by Gregg Tieken, CPS Environmental Manager.

1.4.2 Acknowledgement and Signature

CDM Smith acknowledges that the CCW impoundments referenced herein were assessed by Jamal Daas, P.E. and Bevin Barringer, P.E. Based on the documentation provided, the SRH Pond and Evaporation Pond are rated **SATISFACTORY**.

We certify that the CCW impoundments referenced herein have been assessed on August 27 and 28, 2012.



Jamal Daas, P.E.
Geotechnical Engineer
Texas Registration No. 112062

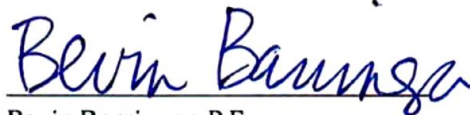
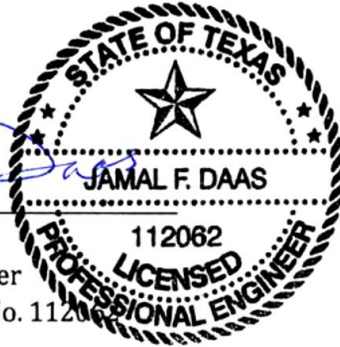

Bevin Barringer, P.E.
Geotechnical Engineer

Section 2

Description of the Coal Combustion Waste (CCW) Impoundment(s)

2.1 Location and General Description

The J.K. Spruce Power Plant (Plant), owned by CPS Energy (CPS) is located in Bexar County at 12940 U.S. Highway 181 South, San Antonio, Texas (Latitude: 29° 18' 25.93" N, Longitude: 98° 19' 12.71" W), as shown on **Figure 2-1**. Critical infrastructure within approximately five miles downgradient of the Plant is shown on **Figure 2-2**. The Plant site is surrounded by open grassy areas with patches of trees, as shown on **Figure 2-3**. The Plant is surrounded by CPS-owned Calaveras Lake on the west, south, and east sides. Land to the north of the Plant property boundary is rural. The Plant site is shared with the J.T. Deely Power Plant also owned by CPS.

The Plant has two Coal Combustion Waste (CCW) impoundments: the Sludge Recycle Holding (SRH) Pond just east of the plant units and the Evaporation Pond approximately 1 mile northeast of the plant units as shown on Figure 2-2. Both ponds were constructed as diked impoundments. The SRH Pond includes a divider wall that can separate the pond into a north and south section but includes a gate that is open during normal operating procedures. The SRH Pond is located to the east of Plant property, between the main Plant site and Calaveras Lake. The Evaporation Pond receives boiler chemical cleaning waste from CPS's J.K. Spruce Power Plant and their J.T. Deely Power Plant. Accordingly, the assessment of the Evaporation Pond is also included in a separate report by CDM Smith prepared for the J.T. Deely Power Plant. The Evaporation Pond is located to the north of the CPS property in an undeveloped area surrounded by trees.

The North and South Bottom Ash Ponds, also located at the site, are used to store CCW from the J.T. Deely Power Plant. The South Bottom Ash Pond is located east of the SRH Pond, and shares a common embankment that includes spillways. The assessment of the North and South Bottom Ash Ponds is included in a separate report by CDM Smith prepared for the J.T. Deely Power Plant. Other impoundments at the site that do not store CCW include the Coal Pile Runoff pond used to store stormwater runoff from the coal storage area, #1 Stormwater Runoff Pond used to store stormwater runoff from the plant site, and the 5-year Landfill Runoff Pond used to store runoff from the fly ash disposal landfill and Class I landfill. The #1 Stormwater Runoff Pond is located just north of the SRH Pond and shares a common embankment. The layout of the ponds is shown on Figure 2-3.

The SRH Pond has a total perimeter of approximately 1,550 feet and an approximate surface area of 3.5 acres. The Evaporation Pond has a total perimeter of approximately 1,800 feet and an approximate surface area of 4.5 acres. **Table 2-1** shows a summary of the approximate size and dimensions of the impoundments.

Table 2-1 – Summary of Impoundments Approximate Dimension and Size

	Impoundment	
	SRH Pond	Evaporation Pond
Dam Height (feet)	8	22
Average Crest Width (feet)	15	20
Length (feet)	1,550	1,800
Interior Slopes, H:V	3:1	2:1
Exterior Slopes, H:V	3:1	3:1

Note: All dimensions were obtained from construction drawings.

2.1.1 Horizontal and Vertical Datum

Project drawings provided by CPS to CDM Smith did not include reference to the horizontal datum used. Based on the coordinates shown on the drawings, the date of the drawings, and the datum in general use at the time, it is likely that the drawings were referenced to the North American Datum of 1983 (NAD 83). Elevations included on the drawings are referenced to mean sea level (MSL). Elevations noted herein are in feet and are referenced to the datum used for the project drawings, MSL, unless otherwise noted.

2.1.2 Site Geology

The J.K. Spruce Electric Plant is located in southeastern Bexar County, Texas. Based on review of the USGS Topographic Map, natural ground surface elevations in the area of the Plant range from approximately El. 490 to El. 530 feet referenced to the North American Vertical Datum of 1988. According to the Quaternary Geologic Map of the Austin 4 x 6 Quadrangle published by the United States Geological Survey, the Plant is located on clayey sand and sandy clay decomposition residuum from the Quaternary and Tertiary Periods. These deposits consist of gray, light brown, brown, or orange clayey, fine to medium quartz sand to fine sandy silty clay with subrounded sandstone pebbles, colluviums, and small bedrock outcrops in some localized areas. According to the United States Department of Agriculture, surface soils in the area are comprised of fine sand, loamy fine sand, and sandy clay loam.

Soil boring information was provided in a report prepared by Raba Kistner Consultants, Inc. (RKCI) dated May 7, 2014. In the RKCI report, the embankment fill is described as sandy clay and clayey sand. The subgrade stratigraphy includes sandy clay and clayey sand with isolated tan and gray clay seams. The 2014 RKCI report is included in **Appendix A**.

2.2 Coal Combustion Residue Handling

The SRH Pond receives flue gas desulphurization (FGD) scrubber sludge from Spruce Units 1 & 2. The pond also receives low-volume waste, stormwater from the material storage area, quench water, and metal cleaning waste. Solids are excavated from the pond every other year, on average, and disposed of in an on-site Plant-owned landfill approximately 1.5 miles north of the SRH Pond.

The Evaporation Pond receives boiler chemical cleaning waste that is trucked to the pond. The Evaporation Pond was constructed on top of a fly ash landfill that was converted into an ash impoundment in 1996. The ash landfill and impoundment were used to store ash materials at some time in the past but no further documentation was provided regarding the nature or amount of ash materials stored. Because it is unknown if the underlying pond was used to store CCW, a full assessment was performed on the Evaporation Pond. A geotechnical engineering study, performed by

RKCI, dated May 2014, included four borings through the Evaporation Pond embankments and into the underlying soils. As per the investigation's boring logs, soils underlying the embankment consisted of medium dense to very dense clayey sand.

Bottom ash from the Plant is stored in CPS' JT Deely bottom ash ponds. Bottom ash excavated from the ponds is recycled. Fly ash from the Plant is stored in on-site silos. From the silos, fly ash is transported by vehicle for use in cement. During periods of low demand for cement, the fly ash is transferred to the landfill for temporary storage. Boiler slag from the Plant is mixed with bottom ash and recycled.

2.3 Size and Hazard Classification

According to the United States Army Corps of Engineers (USACE) Guidelines for Safety Inspection of Dams (1979) (ER 1110-2-106), impoundments are categorized per **Table 2-2**.

Table 2-2 – USACE ER 1110-2-106 Size Classification

Category	Impoundment	
	Impoundment Storage Capacity (acre-feet)	Embankment Height (feet)
Small	50 to < 1000	25 to < 40
Intermediate	1000 to < 50,000	40 to < 100
Large	> 50,000	> 100

The total storage capacity of the SRH Pond and Evaporation Pond is approximately 28 and 99 acre-feet, respectively. Therefore, the SRH Pond embankment is not classified as a dam and the Evaporation Pond embankment is classified as a small dam, as defined in ER 1110-2-106. The impoundment capacities were estimated by CDM Smith based on the geometry shown on the original construction drawings provided by CPS.

It is not known if the Plant impoundments currently have an assigned Hazard Potential Classification. Based on the USEPA classification system as presented on Page 2 of the USEPA checklist (**Appendix B**) and CDM Smith's review of the site and downstream areas, recommended hazard ratings have been assigned to the impoundments as summarized in **Table 2-3**:

Table 2-3 – Recommended Impoundment Hazard Classification Ratings

Ash Pond Unit	Recommended Hazard Rating	Basis
SRH Pond	Significant Hazard	<ul style="list-style-type: none"> ▪ Failure or miss-operation would result in flow toward the main plant facilities resulting in damage to plant infrastructure, operations, and utilities. ▪ Loss of human life is not anticipated.
Evaporation Pond	Low Hazard	<ul style="list-style-type: none"> ▪ Failure or miss-operation would result in low economic and/or environmental losses. ▪ Losses would be limited to the owner's property ▪ Loss of human life is not anticipated.

2.4 Amount and Type of Residuals Currently Contained in the Unit(s) and Maximum Capacity

According to CPS representatives, accumulated solids in the SRH Pond are removed approximately every other year and disposed of in an on-site landfill. The pool area of the SRH Pond is approximately 3.5 acres, and liquids from the pond are treated at a clarifier and discharged to Calaveras Lake.

CPS did not have any information of the amount or types of CCW that may have been stored beneath the existing Evaporation Pond. The Evaporation Pond is approximately 4.5 acres, nearly full of solids, and is used to store and dewater, through evaporation, boiler chemical cleaning waste that is trucked to the pond.

2.5 Principal Project Structures

Principal structures of the SRH Pond include the following:

- A center concrete divider wall with a gate opening dividing the SRH Pond into north and south sections;
- Two 8-inch-diameter welded steel inlet pipes on the center divider wall, one into the north section and one into the south section, discharging liquids from Plant drains;
- Two 6-inch-diameter welded steel inlet pipes on the center divider wall, one into the north section and one into the south section, discharging liquids from the waste slurry sump;
- Two 8-inch-diameter and two 6-inch-diameter welded steel inlet pipes near the east embankment interior slope, one of each at the north section and one of each at the south section, discharging liquids from the clarifier;
- Four 6-inch-diameter welded steel inlet pipes on the center divider wall, two into the north section and two into the south section, discharging liquids from Plant sumps;
- Two 6-inch-diameter welded steel inlet pipes on the center divider wall, one into the north section and one into the south section, discharging liquids from the limestone prep area;
- Two 6-inch-diameter welded steel inlet pipes on the center divider wall, one into the north section and one into the south section, discharging liquids from the thickener sump;
- Two 6-inch-diameter welded steel inlet pipes on the center divider wall, one into the north section and one into the south section, discharging reclaim water;
- Two 4-inch-diameter welded steel inlet pipes on the center divider wall, one into the north section and one into the south section, discharging liquids from the transfer tower sump;
- Two 6-inch-diameter and six 4-inch-diameter unlabeled welded steel inlet pipes on the center divider wall;
- Two 18-inch-diameter welded steel outlet pipes near the west embankment interior slope, one at the north section and one at the south section, where liquids are pumped from the pond to the clarifier; and

- Earthen perimeter embankments composed of sandy clay and clayey sand fill, with interior slopes and pond bottom covered with a 30-mil High-density polyethylene (HDPE) liner and 6-inch-thick concrete slab.

Principal structures of the Evaporation Pond include the following:

- Earthen perimeter embankments composed of sandy clay and clayey sand fill.

2.6 Critical Infrastructure within Five Miles Downgradient

Based on available topographic maps, surface drainage in the vicinity of the Plant appears to be toward Calaveras Lake. Critical infrastructure within five miles downgradient of the impoundments includes the Town of Elmendorf, TX, located just south of Calaveras Lake and approximately 3.5 miles south of the Plant. The only known infrastructure within 5 miles downgradient of the Plant included places of worship, as shown on Figure 2-1. However discharge at any of the impoundments would ultimately be contained in Calaveras Lake, due its large size covering approximately 3,000 acres.

Due to its proximity to the main Plant site, failure of the SRH Pond impoundment would likely result in flow toward the Plant facilities and would result in damage to plant infrastructure, operations, and utilities. Loss of human life is not anticipated.. A breach of the impoundment embankments would most likely impact Plant property and Calaveras Lake.

Because of its relatively remote location, failure or misoperation of the Evaporation Pond would likely result in discharge to the surrounding wooded area and eventually flow into Calaveras Lake.

PW:\PW_XM1\Documents\51119193083_Spruce\03 Reports and Studies\09 CADD Figures and Graphics\B001\VMFG.DWG
© 2012 CDM SMITH ALL RIGHTS RESERVED. REUSE OF DOCUMENTS, THESE DOCUMENTS AND DESIGNS PROVIDED BY PROFESSIONAL SERVICE, INCORPORATED HEREIN, ARE THE PROPERTY OF CDM SMITH AND ARE NOT TO BE USED, IN WHOLE OR PART, FOR ANY OTHER PROJECT WITHOUT THE WRITTEN AUTHORIZATION OF CDM SMITH.
© 2012 CDM Smith / GTS-GEOTECHNICAL & TUNNELING SERVICES DIVISION

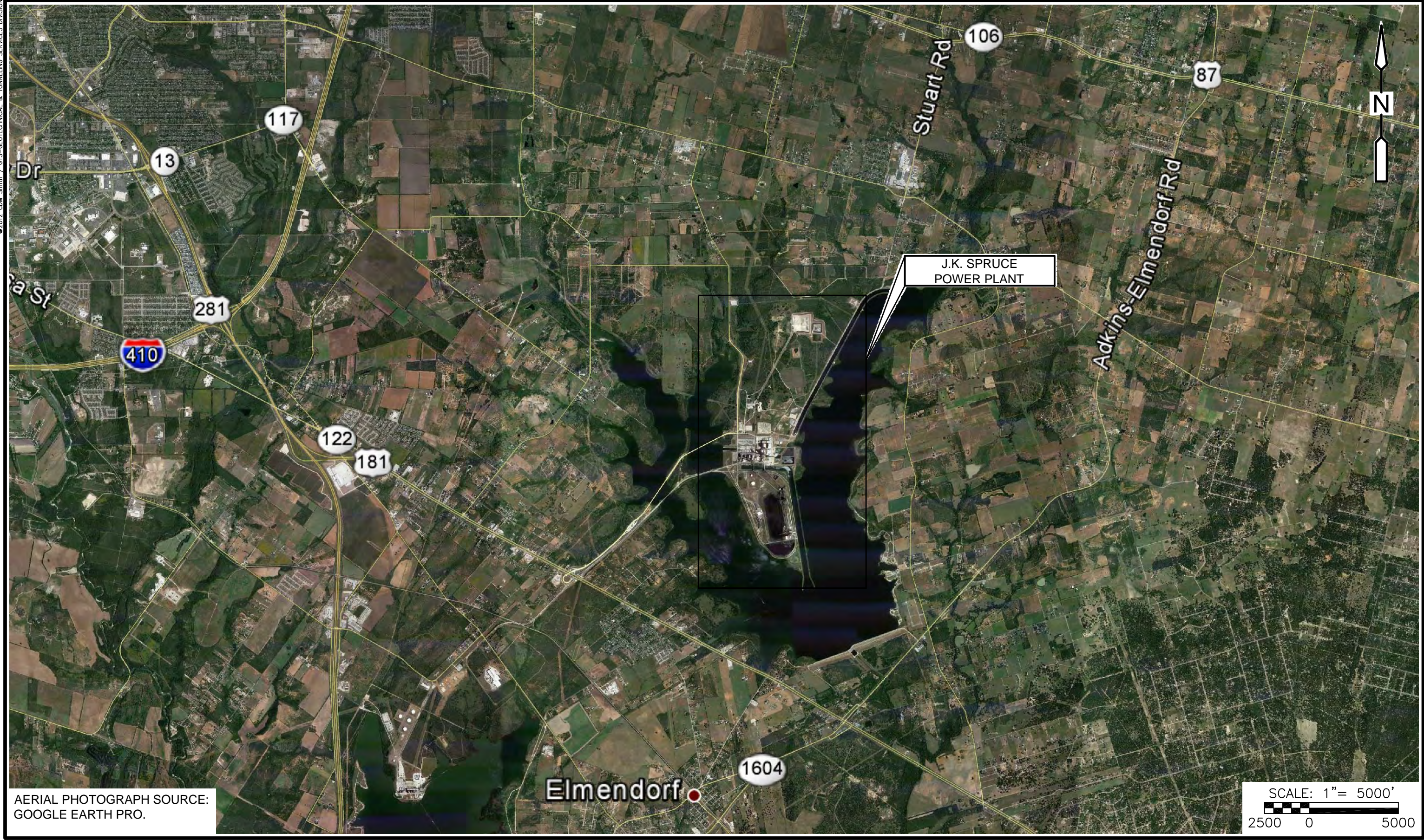

AERIAL PHOTOGRAPH SOURCE:
GOOGLE EARTH PRO.



SCALE: 1" = 5000'
2500 0 5000

J.K. SPRUCE POWER PLANT
SAN ANTONIO, TEXAS
VICINITY MAP
FIGURE 2-1

PW:\IPW_XM1\Documents\51119\93083_Spruce\03 Reports and Studies\09 CADD Figures and Graphics\B002C\FIG.DWG
© 2012 CDM SMITH ALL RIGHTS RESERVED. REUSE OF DOCUMENTS: THESE DOCUMENTS AND DESIGNS PROVIDED BY PROFESSIONAL SERVICE, INCORPORATED HEREIN, ARE THE PROPERTY OF CDM SMITH AND ARE NOT TO BE USED, IN WHOLE OR PART, FOR ANY OTHER PROJECT WITHOUT THE WRITTEN AUTHORIZATION OF CDM SMITH.
© 2012 CDM Smith / GTS-GEOTECHNICAL & TUNNELING SERVICES DIVISION

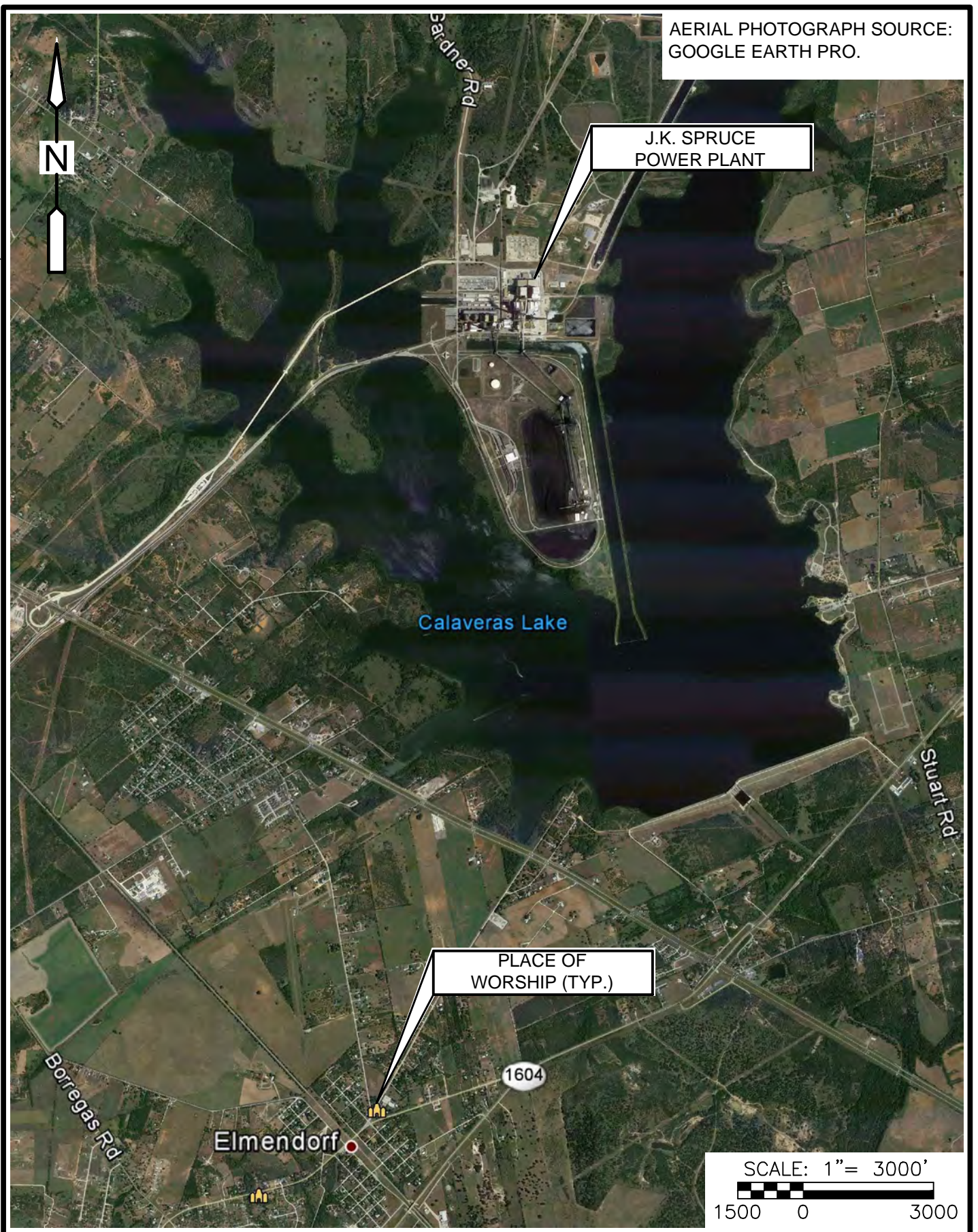

AERIAL PHOTOGRAPH SOURCE:
GOOGLE EARTH PRO.

J.K. SPRUCE
POWER PLANT

Calaveras Lake

PLACE OF
WORSHIP (TYP.)

Elmendorf

1604

SCALE: 1" = 3000'
1500 0 3000



J.K. SPRUCE POWER STATION
SAN ANTONIO, TEXAS
CRITICAL INFRASTRUCTURE PLAN
FIGURE 2-2

PW:\IPW_XM1\Documents\51119\93083_Spruce\03 Reports and Studies\09 CADD Figures and Graphics\B003SPFG.dwg
© 2012 CDM SMITH ALL RIGHTS RESERVED. REUSE OF DOCUMENTS: THESE DOCUMENTS AND DESIGNS PROVIDED BY PROFESSIONAL SERVICE, INCORPORATED HEREIN, ARE THE PROPERTY OF CDM SMITH AND ARE NOT TO BE USED, IN WHOLE OR PART, FOR ANY OTHER PROJECT WITHOUT THE WRITTEN AUTHORIZATION OF CDM SMITH.
© 2012 CDM Smith / GTS-GEOTECHNICAL & TUNNELING SERVICES DIVISION

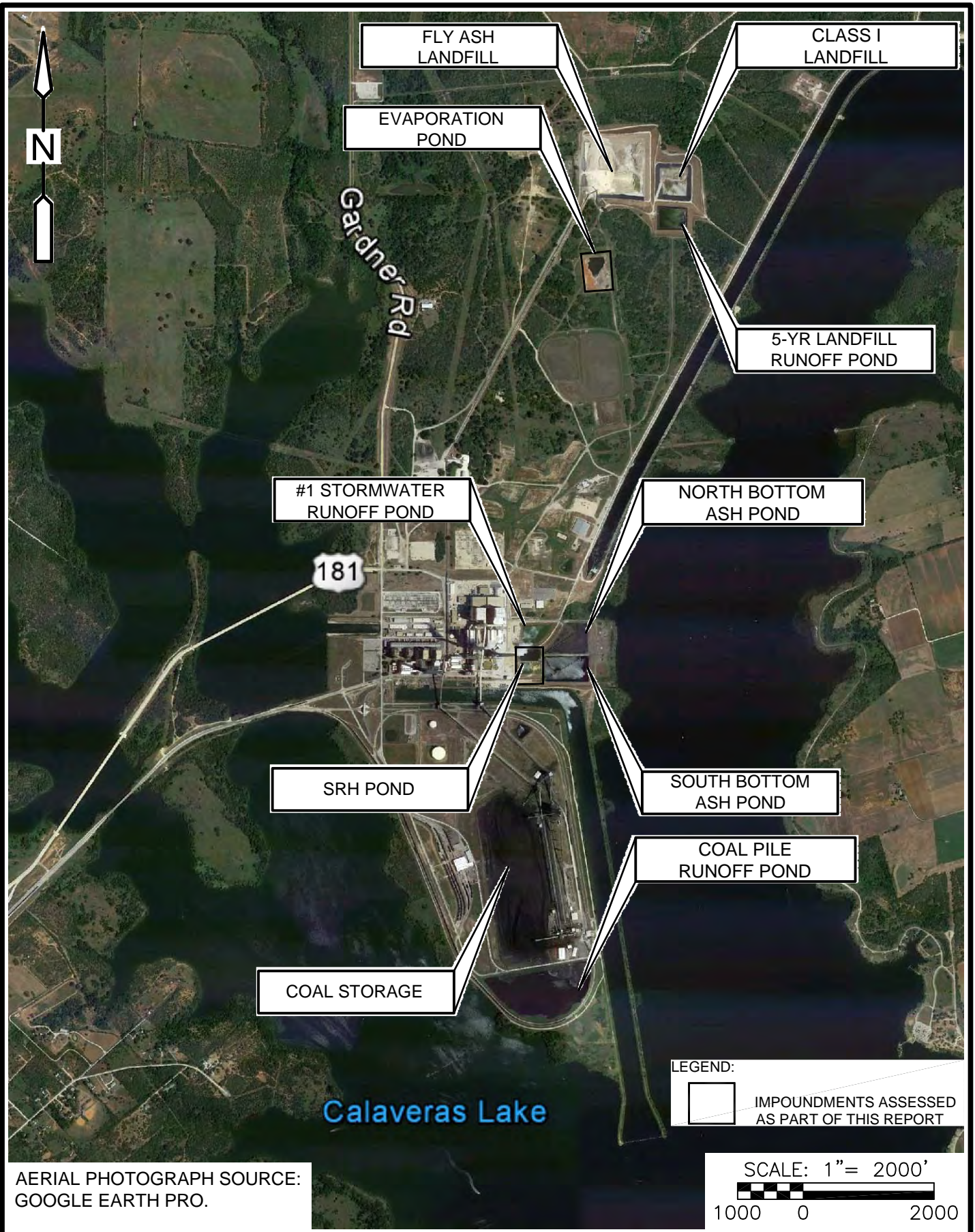

J.K. SPRUCE POWER PLANT
SAN ANTONIO, TEXAS
SITE PLAN
FIGURE 2-3

Section 3

Summary of Relevant Reports, Permits and Incidents

3.1 Summary of Reports on the Safety of the Management Units

Safety reports for the CCW impoundments were not available for CDM Smith's review during the course of this investigation. CPS indicated that to their knowledge no formal inspections of the impoundments have been performed and no safety reports prepared.

CPS representatives indicated to their knowledge there have been no known structural or operational problems associated with the CCW impoundments.

3.2 Summary of Local, State, and Federal Environment Permits

Currently, the CCW impoundments are regulated by the Texas Commission on Environmental Quality (TCEQ).

The J.K. Spruce Power Plant was issued a permit by TCEQ under the National Pollutant Discharge Elimination System (NPDES) which includes outfalls for the SRH Pond. The Plant discharges liquids from the SRH Pond into Calaveras Lake under this permit. The permit, WQ0001514000, was issued on October 18, 2011 and expires on March 1, 2015. Because the Evaporation Pond does not include outlet structures, it is not included in the NPDES permit.

3.3 Summary of Spill/Release Incidents

According to CPS representatives, no releases or spills have occurred at the SRH Pond and Evaporation Pond.

Section 4

Summary of History of Construction and Operation

4.1 Summary of Construction History

4.1.1 Impoundment Construction and Historical Information

The J.K. Spruce Power Plant Unit 1 began operation in 1992 and Unit 2 began operation in 2011. The Plant has two coal fired units and generates electricity with a total capacity of approximately 1300 megawatts of power.

The SRH Pond was constructed in 1992. Historical information on the SRH Pond available for review included original construction drawings provided in **Appendix C**. The SRH Pond was constructed between the existing J.T. Deely South Bottom Ash Pond and the main Plant site. Construction drawings show that the SRH Pond includes perimeter embankments approximately 8-foot-high, 15-ft-wide crests, with interior and exterior side slopes at 3 horizontal to 1 vertical (3H:1V). Crests were constructed to El. 500 and the bottom of the pond to El. 492. Construction documents appear to indicate the embankments were constructed with on-site excavated material however the location for the source of the embankment fill is unknown. Interior slopes and the bottom of the pond were lined with a 6-inch-thick concrete slab underlain by a 30-mil HDPE liner sandwiched between 10 oz geotextile. A concrete divider wall was constructed along the center of the SRH Pond, dividing the impoundment into a north and south section. The divider wall includes a gate which is left open during normal operating procedures. Interior slopes of the north and south embankments include 15-ft-wide concrete driveway ramps down into the north and south sections of the impoundment. Pond sumps and piping are located at the west embankment interior slope. A clarifier pad was constructed on the east embankment crest. Two, 8-foot-wide concrete spillways, with invert El. 499.5, into the existing South Bottom Ash Pond were constructed on the east embankment. No historical subsurface soil information in the vicinity of the SRH Pond was provided. Borings performed in 2012 by RKCI indicate that the embankments consist of sandy clay and clayey sand fill material, and underlying native material consists of sandy clay and clayey sand with isolated tan and gray clay seams.

The Evaporation Pond was constructed on top of an area that was previously used as a fly ash landfill and fly ash impoundment. Based on information provided by CPS the embankments were originally constructed sometime in the past for use as a fly ash landfill. No documentation on the original construction of the fly ash landfill was provided. In 1996 the landfill was converted into a fly ash impoundment. Construction drawings dated 1990 show the existing embankments with a crest elevation at El. 522 and bottom of the impoundment at El. 500. These construction drawings are included in Appendix C. The exterior and interior slopes are shown at 3H:1V. The crest is shown as 6 feet wide at the south embankment, 20 feet wide at the west and east embankments, and 30 feet wide at the north embankment. The 1990 construction drawings show a 30-mil PVC liner was added to the interior slopes of the embankments. The function of the fly ash impoundment changed from storing fly ash to dewatering boiler chemical cleaning waste at some time after 1996.

4.1.2 Significant Changes/Modifications in Design since Original Construction

Based on information provided by CPS, there have been no significant changes or modifications to the SRH Pond since original construction.

Based on information provided by CPS representatives, changes/modifications to the Evaporation Pond include converting it from a fly ash landfill into a fly ash impoundment, and then using it as an evaporation pond for boiler chemical cleaning wastes. No documentation on the original construction of the fly ash landfill was provided. The only changes/modifications documented include the addition of the PVC liner shown on the 1990 construction drawings. Based on the visual observations during the site assessment, it appears the current configuration of the Evaporation Pond is consistent with the 1990 drawings.

4.1.3 Significant Repairs/Rehabilitation since Original Construction

According to information provided by CPS no significant repairs or rehabilitation have been made to the SRH Pond and Evaporation Pond.

4.2 Summary of Operational Procedures

4.2.1 Original Operating Procedures

The SRH Pond has historically been used as clarifier and settling ponds for FGD scrubber sludge received from the Plant. Waste water streams discharged into the SRH Pond have included:

- FGD scrubber sludge
- Low volume waste
- Metal cleaning waste
- Stormwater from material storage
- Quench water

The fly ash impoundment underlying the Evaporation Pond has historically been use as a fly ash landfill and fly ash impoundment to store fly ash generated by the J.T. Deely and J.K. Spruce Power Plants. Recently the Evaporation Pond has been used to dewater, through evaporation, boiler chemical cleaning wastes. Waste stored in the Evaporation Pond has included:

- Fly ash
- Boiler chemical cleaning wastes

4.2.2 Significant Changes in Operational Procedures and Original Startup

No significant changes in operational procedures had been made to the SRH Pond. There was no documentation provided that indicates different.

As previously mentioned the Evaporation Pond's function and operational procedures have changed over the years. Previously the Evaporation Pond's embankments contained a fly ash landfill and fly ash impoundment. Currently the impoundment only receives boiler chemical cleaning wastes that are transported to the pond by truck.

4.2.3 Current CCW Impoundment Configuration

The SRH Pond and Evaporation Pond are currently configured as previously described and as shown on Figure 2-3. The approximate crest elevations of the embankments and pond areas are shown on **Table 4-1** below.

Table 4-1 – Approximate Crest Elevations and Surface Areas

Ash Pond	Approximate Crest Elevation (Feet)	Approximate Pond Surface Area (Acres)
SRH Pond	500	3.5
Evaporation Pond	522	4.5

Over the life of the impoundment, solids have been excavated from the SRH Pond approximately every other year. Solids in the northern and southern portions of the SRH Pond were reportedly last excavated in 2011. The Evaporation Pond was previously used to store fly ash, and during the site assessment solids in the impoundment were up to 0.5 to 2 feet below the crest elevation.

Under normal operating conditions, liquids are discharged into the north and south sections of the SRH Pond through several pipes discharging along the center divider wall. Outlet structures include an 18-inch-diameter outlet pipe at both the north and south section of the pond with invert elevations El. 492.5 that is used to pump water from the pond to the clarifier. After passing through the clarifier, liquids from the pond are discharged into Calaveras Lake through outfall 109 located at the Plant's intake canal just south of the pond.

Under normal operating conditions boiler chemical cleaning wastes are transported by truck to the Evaporation Pond. The cleaning wastes are stored in the pond and dewatered, through evaporation, and no liquids are discharged from the impoundment.

4.2.4 Other Notable Events since Original Startup

Based on furnished information, there are no other notable events since original startup of the SRH Pond and Evaporation Pond to report at this time.

Section 5

Field Observations

5.1 Project Overview and Significant Findings (Visual Observations)

CDM Smith performed visual assessments of the impoundments at the J.K. Spruce site. Impoundments assessed included the SRH Pond and the Evaporation Pond. The SRH Pond is located between the generating units and Calaveras Lake. The Evaporation Pond is located approximately 1 mile northeast of the generating units. The perimeter embankments of the SRH Pond are approximately 1,550 feet in length, and approximately 8 feet in height. The perimeter embankments of the Evaporation Pond are approximately 1,800 feet in length and approximately 22 feet in height. The assessments were completed following the general procedures and considerations contained in Federal Emergency Management Agency's (FEMA's) Federal Guidelines for Dam Safety (April 2004) to make observations concerning settlement, movement, erosion, seepage, leakage, cracking, and deterioration. A Coal Combustion Dam Inspection Checklist and Coal Combustion Waste (CCW) Impoundment Inspection Form, developed by USEPA, was completed for each of the aforementioned impoundments. Copies of these forms are included in Appendix B. Photograph locations are shown on **Figures 5-1** through **5-2**, and photographs are included in **Appendix D**. Photograph locations were logged using a handheld GPS device. The photograph coordinates are listed in Appendix D.

CDM Smith visited the plant on August 27 and 28, 2012, to conduct visual assessments of the impoundments. The weather was generally sunny with daytime high temperatures up to 100 degrees Fahrenheit. The daily total precipitation prior to the site visit is shown in **Table 5-1**. The data was obtained from the National Oceanic and Atmospheric Administration (NOAA) station at the San Antonio Stinson Municipal Airport, approximately 9 miles west of the Plant.

Table 5-1 – Approximate Precipitation Prior to Site Visit

Date of Site Visit – August 27 and 28, 2012		
Day	Date	Precipitation (inches)
Monday	August 26	0
Sunday	August 25	0
Saturday	August 24	0
Friday	August 23	0
Thursday	August 22	0
Wednesday	August 21	0
Tuesday	August 20	0
Monday	August 19	2.05
Total	(August 19-26, 2012)	2.05
Total	Month Prior to Site Visit (July 26 – August 26, 2012)	2.38

Note: Precipitation data from NOAA. Station Location: San Antonio Stinson Municipal Airport. Lat. 28.3389; Lon. -98.472; EL.571 ft.

5.2 SRH Pond

At the time of the assessment, the SRH Pond contained solids and liquids with approximately 5 feet of freeboard. An overview of the photographs taken at the SRH Pond during the CDM Smith site assessment is included in Figure 5-1.

5.2.1 Crest

The crest of the SRH Pond appeared to be in satisfactory condition (Photographs 3, 13, 20, and 50). The crest was approximately 15 feet wide at all embankments except at the east embankment where it widened to approximately 50 feet to accommodate the clarifier pad (Photograph 8). Two spillways that connect the SRH and South Bottom Ash Ponds were located on the east embankment crest (Photographs 5 and 9). Supports for overhead piping were located at the west embankment crest (Photograph 22). The crest of the embankments consists of compacted granular soils and gravel and is exposed to minimal vehicle traffic. No depressions or evidence of settlement were observed on the crest.

5.2.2 Interior Slopes

Interior slopes of the SRH Pond appear to be in fair condition (Photographs 4, 12, 14, 19, 45, and 51). Interior slopes were at 3H:1V and covered in a layer of granular material and other solids. Some sparse vegetation was observed in limited areas on the east and north embankment interior slopes (Photographs 4, 8, 9, and 17). Concrete roadway ramps into the pond for equipment access were located at the north and south embankment interior slopes (Photographs 17 and 53). Two spillway inlets were located on the east embankment interior slope (Photograph 7 and 11). Piping and sump pumps were located on a concrete pad built into the west embankment interior slope (Photograph 19 and 25). Visible portions of interior slopes did not include riprap or other armoring.

5.2.3 Exterior Slopes

Exterior slopes of the SRH Pond appear to be in fair condition (Photographs 1, 15, 21, 46, and 52). The exterior slopes of the north, west, and south embankments are approximately 3H:1V and covered in grassy vegetation approximately 3 inches tall. The north embankment is shared with the #1 Stormwater Runoff Pond (Photograph 15). The east embankment is shared with the South Bottom Ash Pond and is covered in ash material and vegetation (Photographs 1, 6, and 10). Two spillway outlets were located on the east embankment exterior slope (Photograph 6 and 10). No areas of erosion or indications of seepage were observed at the spillways.

5.2.4 Inlet Piping

Several inlet pipes discharge liquids near into the north section of the SRH Pond; four 4-inch-diameter, eight 6-inch-diameter and two 8-inch-diameter metal pipe (Photographs 33, 38, 39, 40, 41, 42, 43, and 44). Inlet pipes discharging liquids into the south section of the SRH Pond include; four 4-inch-diameter, eight 6-inch-diameter and two 8-inch-diameter metal pipe (Photographs 26, 28, 30, 31, 32, 34, 35, 36, and 37).

5.2.5 Outlet Structures

The outlet structure near the west embankment interior slope consists of two 18-inch-diameter steel outlet pipes, one is located in the north section of the pond and one is in the south section. The outlet pipes were submerged during the site assessment (Photographs 24 and 27). CCW is pumped through the outlet pipes to the clarifier located at the east embankment crest (Photograph 8). Liquids from the clarifiers are discharged to outfall 109 at the Plant intake canal (Photographs 55, 56, and 57).

5.3 Evaporation Pond

At the time of the assessment, the Evaporation Pond contained solids and boiler chemical cleaning wastes that were being dewatered in the impoundment with approximately 2 feet of freeboard. An overview of the photographs taken at the Evaporation Pond during the CDM Smith site assessment is included in Figure 5-2.

5.3.1 Crest

The embankment crest of the Evaporation Pond appeared to be in satisfactory condition (Photographs 58, 68, 76, and 82). The crest was approximately 15 feet wide at all embankments except the north embankment which measured approximately 50 feet wide. The crest of the embankment consists of a compacted gravel drive and grass. The surface is exposed to minimal vehicle traffic. No depressions or evidence of settlement were observed on the crest.

5.3.2 Interior Slopes

Due to the level of solids and water in the Evaporation Pond during the assessment, only the upper 0.5 to 2 ft of the interior slopes were visible (Photographs 59, 69, 70, 74, and 83). Vegetation covered some portions of the west and south embankment interior slopes (Photographs 79, 83, and 88). Ash and other solid material extend up to the crest near the southeast corner interior slope and on the east embankment interior slope (Photographs 59 and 90). Visible portions of interior slopes did not include riprap or other armoring.

5.3.3 Exterior Slopes

The exterior slopes appear to be in satisfactory condition and are covered in grassy vegetation approximately 2 feet high and a few small trees and bushes with diameters less than 6 inches in diameter (Photographs 61, 66, 77, and 87). Areas of loose soil were observed at the east embankment exterior slope (Photographs 60, 62, and 64) and an animal burrow was observed at the west embankment exterior slope (Photograph 78). An area of exposed soil was observed at the south embankment exterior slope (Photograph 85). Based on construction drawings, the exterior slopes are 3H:1V at all embankments, though slopes measured in the field ranged from 3H:1V to 4H:1V (Photographs 65 and 86). Trees up to 12 inches in diameter were located at the toe of all embankments (Photographs 63, 73, 80, and 87).

PW:\IPW_XM1\Documents\51119\93083_Spruce\03 Reports and Studies\09 CADD Figures and Graphics\B004PHFG.DWG
© 2012 CDM SMITH ALL RIGHTS RESERVED. REUSE OF DOCUMENTS: THESE DOCUMENTS AND DESIGNS PROVIDED BY PROFESSIONAL SERVICE, INCORPORATED HEREIN, ARE THE PROPERTY OF CDM SMITH AND ARE NOT TO BE USED, IN WHOLE OR PART, FOR ANY OTHER PROJECT WITHOUT THE WRITTEN AUTHORIZATION OF CDM SMITH.
© 2012 CDM Smith / GTS-GEOTECHNICAL & TUNNELING SERVICES DIVISION

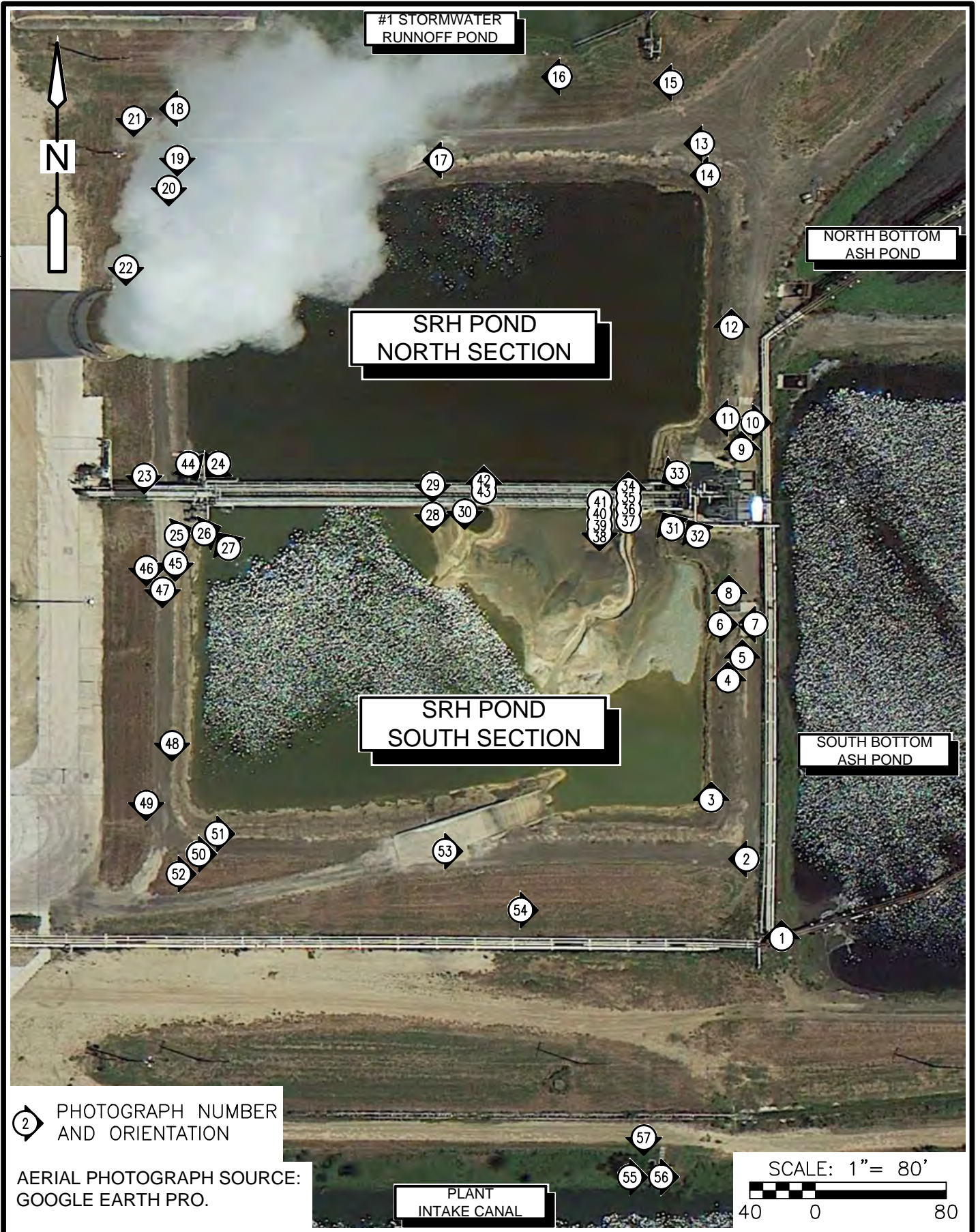

② PHOTOGRAPH NUMBER AND ORIENTATION

AERIAL PHOTOGRAPH SOURCE: GOOGLE EARTH PRO.

SCALE: 1" = 80'
40 0 80



J.K. SPRUCE POWER PLANT
SAN ANTONIO, TEXAS
SRH POND
FIGURE 5-1

PW:\IPW_XM1\Documents\51119\93083_Spruce\03 Reports and Studies\09 CADD Figures and Graphics\B007PHFG.DWG
© 2012 CDM SMITH ALL RIGHTS RESERVED. REUSE OF DOCUMENTS: THESE DOCUMENTS AND DESIGNS PROVIDED BY PROFESSIONAL SERVICE, INCORPORATED HEREIN, ARE THE PROPERTY OF CDM SMITH AND ARE NOT TO BE USED, IN WHOLE OR PART, FOR ANY OTHER PROJECT WITHOUT THE WRITTEN AUTHORIZATION OF CDM SMITH.
© 2012 CDM Smith / GTS-GEOTECHNICAL & TUNNELING SERVICES DIVISION

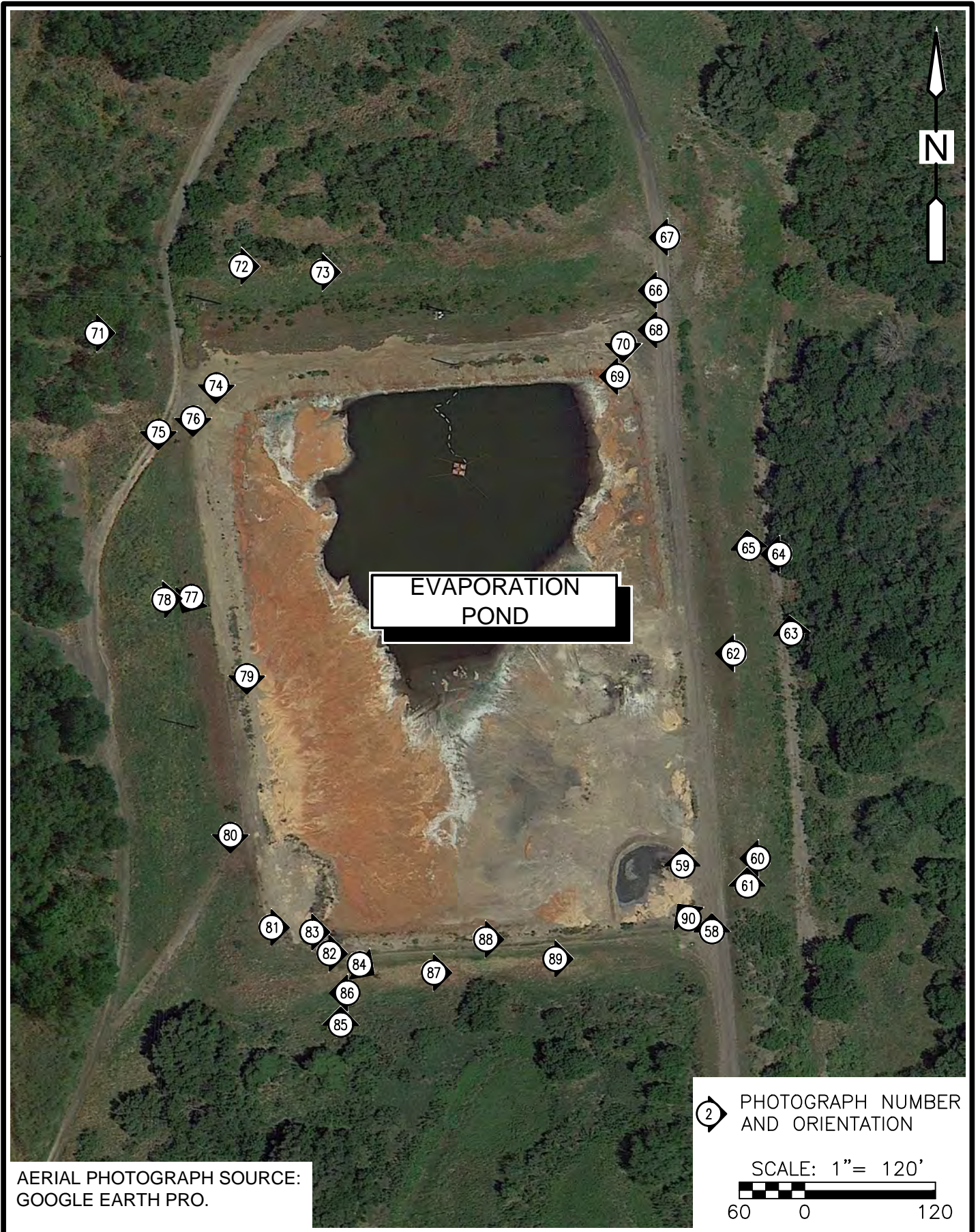

AERIAL PHOTOGRAPH SOURCE:
GOOGLE EARTH PRO.

PHOTOGRAPH NUMBER
AND ORIENTATION

SCALE: 1" = 120'



J.K. SPRUCE POWER PLANT
SAN ANTONIO, TEXAS
EVAPORATION POND
FIGURE 5-2

Section 6

Hydrologic/Hydraulic Safety

6.1 Impoundment Hydraulic Analysis

Because they are off-channel impoundments, coal combustion waste impoundments are not classified as dams by the TCEQ. TCEQ regulates coal combustion waste impoundments as industrial waste impoundments and provides recommendations for construction, operation, and maintenance of all nonhazardous surface impoundments in “Technical Guideline No. 4, Topic: Nonhazardous Industrial Solid Waste Surface Impoundments”, dated June 12, 2009. The guidelines include the Hydrologic/hydraulic recommendation that surface water diversion dikes with a minimum height equal to two (2) feet above the 100-year flood water elevation should be constructed around industrial solid waste surface impoundments located within the 100-year flood plain. Industrial solid waste impoundments located above the 100-year flood water elevation, should include surface water diversion dikes that are, at a minimum, capable of diverting all rainfall runoff from a 24-hour, 25-year storm.

FEMA guidance, as described in “*Selecting and Accommodating Inflow Design Floods for Dams; FEMA P-94 /August 2013*”, recommends hydrologic design of impoundments to consider discharge and storage capacities, reservoir regulation plans, land requirements, and wind/wave effects. FEMA guidelines recommend site-specific hydrologic design for high hazard impoundments which take into consideration the inflow design flood (IDF). FEMA recommends that dams with a low hazard potential be designed for a 1-percent annual chance of exceedance flood (average return frequency of no less than once in 100 years) and that dams with a significant hazard potential be designed for a 0.1-percent annual chance of exceedance flood (average return frequency of no less than once in 1,000 years).

The SRH Pond was classified as a significant hazard impoundment and the Evaporation Pond was classified as a low hazard impoundment. Documentation provided by CPS included Turnkey Contract Documents prepared by Black & Veatch and dated December 31, 1987. These documents included precipitation amounts for selected storm durations and return periods expected in the Calaveras Lake area. Black & Veatch reported a precipitation of 7.75 inches for a 24-hour, 25-year storm, and precipitation ranging from 3.35 inches to 9.92 inches for 100-year storms ranging in duration from ½ hour to 24 hours. No documentation was provided by CPS on the site-specific IDF.

The drainage area contributing to the SRH Pond and the Evaporation Pond appears to be limited to the surface area of the impoundments. A preliminary evaluation performed by CDM Smith suggests there is enough storage capacity under current operating pool levels for the SRH Pond to safely store precipitation from a 0.1-percent annual chance exceedance (1,000-year) flood. A preliminary evaluation performed by CDM Smith suggests there is enough storage capacity under current operating pool levels for Evaporation Pond to safely store precipitation from a 1-percent annual chance exceedance (100-year) flood.

6.2 Adequacy of Supporting Technical Documentation

The hydrologic and hydraulic supporting documentation of the SRH Pond and Evaporation Pond is considered inadequate based on the following:

- H & H documentation provided by CPS included precipitation amounts for selected storm durations and return periods expected in the Calaveras Lake site area. No documentation was provided by CPS on the ability of the impoundments to store the FEMA-recommended design floods.
- An evaluation to determine the required IDF and of the capacity of the SRH Pond and Evaporation Pond to withstand the design hydrologic/hydraulic events, without overtopping have not been provided.

6.3 Assessment of Hydrologic/Hydraulic Safety

Hydrologic and hydraulic safety of the SRH Pond and Evaporation Pond is considered adequate based on the following:

- CDM Smith's preliminary evaluation of the CCW impoundments suggests the SRH Pond and the Evaporation Pond have adequate storage capacity, based on normal operating conditions, to store the recommended floods.

It should be noted that during visual observations and site assessments, no signs of plugged, collapsed, or blocked pipes, or other detrimental conditions were observed.

Section 7

Structural Stability

7.1 Supporting Technical Documentation

The available information regarding slope stability of the SRH Pond and the Evaporation Pond consists of a report titled “Geotechnical Engineering Study for Ash Pond Berms – Spruce/Deely Generation Units, San Antonio, Texas”, prepared by Raba Kistner Consultants, Inc., (RKCI) and dated May 7, 2014. The RKCI May 2014 report supersedes RKCI’s November 12, 2012 report referenced in CDM Smith’s December 2012 “*Assessment of Dam Safety of Coal Combustion Surface Impoundments, CPS Energy, J.K. Spruce Power Plant*”. RKCI’s 2014 report included slope stability analyses for steady-state and seismic loading conditions of the SRH Pond and Evaporation Pond embankments. The calculated factors of safety presented in the RKCI 2014, for the load conditions analyzed, met minimum required factors of safety outlined by the USACE in EM 1110-2-1902, Table 3-1 and seismic factors of safety by FEMA Federal Guidelines for Dam Safety, Earthquake Analyses and Design of Dams. The RKCI 2014 report did not present analyses for liquefaction potential, end-of-construction, and rapid drawdown loading conditions. RKCI stated in the 2014 report that the end-of-construction condition was not evaluated due to the age of the ash ponds. RKCI also stated that both rapid drawdown and erosion failures are considered to be of very low risk due to the embankment toe elevations (above EL 490 feet) with respect to the target pool elevation (EL 485 feet) and because they would pose no risk of environmental contamination, because the pond must empty for this condition to occur. The RKCI May 7, 2014 report is included in Appendix A. A summary of the RKCI 2014 analyses is provided in the following sections.

7.1.1 Stability Analyses and Load Cases

TCEQ recommendations related to embankment stability of coal ash impoundments are included in “Technical Guideline No. 4, Topic: Nonhazardous Industrial Solid Waste Surface Impoundments”, dated June 12, 2009. TCEQ’s Technical Guideline No. 4 recommends all permanent earthen dikes that are used to retain waste or waste waters above ground level should have a top width of at least eight (8) feet and side slopes that are not steeper than one (1) foot vertical to three (3) feet horizontal. TCEQ’s recommended factor of safety against dike slope failure is at least 1.4. In situations where a backup system is not used for potential catastrophic failure of the dikes, TCEQ recommends a minimum factor of safety of 1.5.

Procedures established by the United States Army Corps of Engineers (USACE), the United States Bureau of Reclamation, the Federal Energy Regulatory Commission, and the Natural Resources Conservation Service are generally accepted engineering practice. Minimum required factors of safety outlined by the USACE in EM 1110-2-1902, Table 3-1 and seismic factors of safety by FEMA Federal Guidelines for Dam Safety, Earthquake Analyses and Design of Dams (pgs. 31, 32 and 38, May 2005) are provided in **Table 7-1**.

Table 7-1 - Recommended Minimum Safety Factors

Load Case	Minimum Required Factor of Safety
Steady-State Condition at Normal Pool or Maximum Storage Pool Elevation	1.5
Rapid Drawdown Condition from Normal Pool Elevation	1.3
Maximum Surcharge Pool	1.4
End of Construction	1.3
Seismic Condition at Normal Pool Elevation	1.0
Liquefaction	1.3

RKCI performed slope stability analyses for each of the embankments at the SRH Pond (Sections J, K, L, and M) and each of the Evaporation Pond embankments (Sections A, B, C, and D). Slope stability analyses were performed for steady-state seepage conditions at normal pool and maximum storage pool elevations, using effective stress analyses and for seismic conditions using total stress analyses. Analyses were performed with two feet of freeboard and pond water levels at the top of the crest, corresponding to normal pool and maximum surcharge loading conditions, respectively. Design parameters used in the seismic slope stability analyses included the mapped spectral response acceleration for an earthquake with a 0.098g applied horizontal seismic load. RKCI indicated, in their 2014 report, that the applied horizontal seismic load had a 4-to-6 % probability of exceedance in 50 years. USEPA guidelines specify that the mapped spectral response acceleration for an earthquake with 2% probability of exceedance in 50 years be used in seismic slope stability analyses. CDM Smith used USGS referenced maps, published in the 2010 ASCE-7 Standard, to determine the mapped spectral response acceleration for an earthquake with 2% probability of exceedance in 50 years. CDM Smith found the spectral response acceleration for the Spruce site to be 0.075g.

According to the 2014 RKCI report, rapid drawdown load conditions were not analyzed for slope stability, because the impoundments would be emptied for this condition to occur. The end-of-construction condition was not analyzed because the ponds have been in place for many years. According to information provided by RKCI, slope stability analyses for liquefaction potential were not performed because liquefaction is very unlikely at the site due to the subsurface conditions and low seismic hazard level at the Plant site. As described in Section 1, CDM Smith agrees with RKCI's rationale for not performing these analyses.

7.1.2 Design Parameters and Dam Materials

CPS provided RKCI with field survey drawings for the embankments analyzed. According to the RKCI report, Pape Dawson Engineers, Inc. (PDE) spot-checked the existing embankments and surveyed cross-sections where the existing conditions did not closely resemble the earlier survey data. RKCI performed test soil borings at the embankment crests of the SRH Pond and Evaporation Pond. Four borings were performed at the SRH Pond and four were performed at the Evaporation Pond. Soil and groundwater information obtained from these test borings were used in RKCI's slope stability analyses. The soil properties and strength parameters used in RKCI's steady-state seepage and seismic slope stability analyses are included in **Tables 7-2** and **7-3**, respectively. RKCI refers to the SRH Pond as Pond 1, and the Evaporation Pond as Pond 3.

Table 7-2 - Soil Parameters Used in RKCI's Steady-State Slope Stability Analyses

Pond ID	Clay Fraction %	Assumed Liquid Limit	Normal Stress, psf			
			0	1,044	2,089	8,354
Pond 1						
Embankment Soil (CL)	47	42	0	647	1,158	4,057
Sandy Clay (CL)	52	52	0	561	972	3,281
Clayey Sand (ML)	36	33	0	669	1,197	4,240
Pond 3						
Embankment Fill (CL)	45	45	0	640	1,145	4,023
Sandy Clay (CL)	50	54	0	557	963	3,247
Clayey Sand (ML)	34	55	0	618	1,105	3,859

Source: RKCI May 7, 2014 report, "Geotechnical Engineering Study for Ash Pond Berms – Spruce/Deely Generation Units, San Antonio, Texas".

Table 7-3 - Soil Parameters Used in RKCI's Seismic Slope Stability Analyses

Material	Unit Weight (pcf)	Cohesion (psf)	Phi (degrees)
Embankment Fill	120	350	20
Clayey Sand	120	400	20
Clayey Sand Below Water Table	57.6	400	20
Sandy Clay	120	500	20
Sandy Clay Below Water Table	57.6	500	20

Source: RKCI May 7, 2014 report, "Geotechnical Engineering Study for Ash Pond Berms – Spruce/Deely Generation Units, San Antonio, Texas".

According to the RKCI report, strength parameters for steady-state seepage analyses were selected based on consolidated undrained triaxial compression test results at four different normal stresses and published correlations. The strength parameters selected for the seismic analyses were based on unconfined compressive strength results and experience with similar soils.

7.1.3 Uplift and/or Phreatic Surface Assumptions

According to the 2014 RKCI report, steady-state seepage analyses were performed for each profile using finite element groundwater module within SLIDE, a software program developed by RocScience. The seepage analyses were performed for each embankment cross-section with water levels at the embankment crests. Results of the seepage analyses were used for the steady-state seepage and seismic slope stability analyses.

7.1.4 Factors of Safety and Base Stresses

A summary of factors of safety computed for the different cases of the SRH Pond (Sections J, K, L, and M) and Evaporation Pond (Sections A, B, C, and D) is included in **Table 7-4**.

Table 7-4, Computed Factors of Safety for Various Stability Conditions

Embankment Cross-Section	Factor of Safety Steady-State Stability Analyses ⁽¹⁾		Required Safety Factor	Factor of Safety Factor of Safety ⁽²⁾		Required Safety Factor	Factor of Safety Seismic Stability Analyses		Required Safety Factor	
	Interior Slope	Exterior Slope		Interior Slope	Exterior Slope		Interior Slope	Exterior Slope		
SRH Pond	J	>2	1.5	>2	>2	1.4	>2	>2	1.0	
	K	>2		>2	>2					
	L	>2		>2	>2					
	M	>2		1.7	>2		1.6			
Evaporation Pond	A	>2		>2	>2		>2	>2		>2
	B	>2		>2	>2		>2	>2		>2
	C	>2		1.5	>2		>2	>2		>2
	D	>2		1.9	>2		>2	>2		>2

Source: RKCI May 7, 2014 report, "Geotechnical Engineering Study for Ash Pond Berms – Spruce/Deely Generation Units, San Antonio, Texas".

1. Normal Pool

2. Maximum Surcharge

7.1.5 Liquefaction Potential

CDM Smith was not provided documentation on liquefaction analysis. RKCI stated that liquefaction is very unlikely at the site due to the subsurface soil and groundwater conditions, and seismic conditions at the Plant site. As reported by RKCI, there is less than a 0.1% chance of an earthquake with magnitude of 5.0 or greater in 50 years. Because the site contains significant quantities of relatively stiff clay, RKCI believes the soils beneath the existing embankments have a very low risk of experiencing liquefaction due to an earthquake. Available subsurface information indicates the soils below the embankments consist of fill underlain by medium dense to very dense sandy soils and/or very stiff sandy clay. The liquefaction susceptibility of the dense sandy soils and the stiff clay is generally considered to be low.

7.1.6 Critical Geological Conditions

According to the Quaternary Geologic Map of the Austin 4 x 6 Quadrangle published by the United States Geological Survey, geology in the vicinity of the Plant consists of gray, light brown, brown, or orange clayey, fine to medium quartz sand to fine sandy silty clay with subrounded sandstone pebbles, colluviums, and small bedrock outcrops in some localized areas. According to the United States Department of Agriculture, surface soils in the area are comprised of fine sand, loamy fine sand, and sandy clay loam.

7.2 Adequacy of Supporting Technical Documentation

Existing conditions and visual observations yield a satisfactory rating for structural stability of both the SRH Pond and Evaporation Pond based on the following:

- Steady state and seismic stability analyses for of the SRH Pond and Evaporation Pond embankments are documented.
- RKCI did not analyze liquefaction potential, end-of-construction and sudden drawdown loading conditions. As described in Section 1, CDM Smith agrees with RKCI's rationale for not performing these analyses.

- In their seismic slope stability analyses, RKCI used the mapped spectral response acceleration of 0.098g from the USGS web site calculator. RKCI performed a probabilistic assessment of the likelihood of the project site experiencing a magnitude 5 or larger earthquake within a 50 year period. RKCI's assessment indicated that the probability of occurrence was 4 to 6 percent. USEPA guidelines specify that the mapped spectral response acceleration for an earthquake with 2% probability of exceedance in 50 years be used in seismic slope stability analyses. CDM Smith used USGS referenced maps, published in the 2010 ASCE-7 Standard, to determine the mapped spectral response acceleration for an earthquake with 2% probability of exceedance in 50 years. CDM Smith found the spectral response acceleration for the Spruce site to be 0.075g. Accordingly, in CDM Smith's opinion, the response acceleration employed in RKCI's seismic analyses conforms to USEPA standards.

7.3 Assessment of Structural Stability

Based on the review of the stability analyses and visual observations made during the site visit, CDM Smith considers the condition rating to be satisfactory for structural stability of the SRH Pond and Evaporation Pond.

During CDM Smith's visual observations and site assessment of the Evaporation Pond, the high water and solids level in the impoundments prevented observation of the interior slopes.

Section 8

Adequacy of Maintenance and Methods of Operation

8.1 Operating Procedures

During normal operating procedures the SRH Pond receives FGD scrubber sludge, low-volume waste, stormwater from the material storage area, quench water, and metal cleaning waste from the J.K. Spruce Power Plant. Liquids are discharged into the north and south sections of the SRH Pond through several inlet pipes located near the center divider wall. Liquids are pumped from two 18-inch-diameter outlet pipes, one in the north section and one in the south section of the SRH Pond, to the clarifier. Liquids from the clarifier are discharged to outfall 109 at the Plant intake canal located just south of the SRH Pond. Settled solids are periodically excavated from the SRH Pond and disposed of in an on-site Plant landfill located approximately 1.5 miles north of the impoundment. During the site assessment the SRH Pond contained water and solids. CPS indicated that solids had last been removed in 2011.

During normal operating procedures, the Evaporation Pond receives boiler chemical cleaning wastes generated by the J.T. Deely Power Plant and J.K. Spruce Power Plant that are trucked to the pond. The wastes are dewatered through evaporation. No liquids are discharged from the Evaporation Pond. During the site assessment, solids in the impoundment were up to 0.5 to 2 feet below the crest elevation.

8.2 Maintenance of the Dam and Project Facilities

CPS indicated during the site assessment by CDM Smith on August 27 and 28, 2012, that no formal visual inspections are performed for the SRH Pond and Evaporation Pond.

Regular maintenance operations include mowing adjacent to the SRH Pond and Evaporation Pond.

8.3 Assessment of Maintenance and Methods of Operations

8.3.1 Adequacy of Operating Procedures

Based on CDM Smith's visual observations and review of documents provided by CPS, operating procedures appear to be generally adequate for the impoundments. There is no readily available indication that suggests that the SRH Pond and Evaporation Pond primary purposes are not being accomplished.

8.3.2 Adequacy of Maintenance

Based on CDM Smith's visual observations and review of documents provided by CPS, maintenance of the SRH Pond and the Evaporation Pond appear to be generally adequate. There were no significant maintenance issues at the SRH Pond. Maintenance issues on the exterior slopes of the Evaporation Basin included areas of loose soil and exposed soil, and an animal burrow.

Section 9

Adequacy of Surveillance and Monitoring Program

9.1 Surveillance Procedures

CPS Energy is required by Texas Commission on Environmental Quality (TCEQ) under National Pollutant Discharge Elimination System (NPDES) Permit No. WQ0001514000 to monitor discharge of wastewater into Calaveras Lake. Surveillance procedures should be in accordance with the TCEQ – NPDES Permit.

According to CPS, no surveillance procedures exist for the SRH Pond and Evaporation Pond.

9.2 Instrumentation Monitoring

The SRH Pond and Evaporation Pond do not include any instrumentation monitoring. Water levels are not monitored in the SRH Pond and Evaporation Pond.

The SRH Pond and Evaporation Pond embankments do not have an instrumentation monitoring system to monitor structural stability, seepage or ground displacement.

9.3 Assessment of Surveillance and Monitoring Program

9.3.1 Adequacy of Inspection Programs

The CPS surveillance program for the SRH Pond and Evaporation Pond is inadequate.

9.3.2 Adequacy of Instrumentation Monitoring Program

The CPS instrumentation monitoring program for the SRH Pond and Evaporation Pond is inadequate. CPS representatives confirmed the absence of instrumentation to monitor impoundment conditions. Detrimental conditions or indications for potential failure of embankments were not observed at the SRH Pond or Evaporation Pond.

Section 10

Reports and References

The following is a list of reports and drawings that were provided by CPS and were used during the preparation of this report and the development of the conclusions and recommendations presented herein.

1. Turnkey Contract Documents Volume 4 by Utility Engineering Corporation, dated December 31, 1987,
2. J.K. Spruce Unit 1 Construction Drawings by Utility Engineering Corporation, dated 1989.
3. J.T. Deely/J.K. Spruce Construction Drawings by Frank Tobar, dated 1990.
4. J.K. Spruce Unit 1 Construction Drawings by Utility Engineering Corporation, dated 1992.
5. Raba Kistner Consultants, Inc. Geotechnical Engineering Study, Ash Pond Berms – Spruce/Deely Generation Units, dated November 20, 2012.
6. Raba Kistner Consultants, Inc. Geotechnical Engineering Study, Ash Pond Berms – Spruce/Deely Generation Units, dated May, 2014.

Appendix A

RKCI Geotechnical Engineering Study



GEOTECHNICAL ENGINEERING STUDY

FOR

**ASH POND BERMS - SPRUCE/DEELY GENERATION UNITS
SAN ANTONIO, TEXAS**



Raba Kistner
Consultants, Inc.
12821 W. Golden Lane
San Antonio, TX 78249
P.O. Box 690287
San Antonio, TX 78269
www.rkci.com

P 210 :: 699 :: 9090
F 210 :: 699 :: 6426
TBPE Firm F-3257

Project No. ASA12-098-00 (Revised)
May 7, 2014

Mr. Eric R. Olson
CPS Energy
c/o Mr. Steven Dean, P.E.
Pape-Dawson Engineers, Inc.
555 East Ramsey
San Antonio, Texas 78216

**RE: Geotechnical Engineering Study
Ash Pond Berms – Spruce/Deely Generation Units
San Antonio, Texas**

Dear Mr. Dean:

Raba Kistner Consultants Inc. (RKCI) is pleased to submit the revised report of our Geotechnical Engineering Study for the above-referenced project. This study was performed in accordance with RKCI Proposal No. PSA12-168-00 (3rd Revision), dated October 4, 2012, and comments provided in a conference call on April 17, 2014. The purpose of this study was to drill borings within the existing ash pond berms, to perform laboratory testing to classify and characterize subsurface conditions, and to prepare an engineering report presenting slope stability analyses for the existing berms.

We appreciate the opportunity to be of service to you on this project. Should you have any questions about the information presented in this report, or if we may be of additional assistance with value engineering or on the materials testing-quality control program during construction, please call.

Very truly yours,

RABA KISTNER CONSULTANTS, INC.

R. Blake Wright, E.I.T.
Graduate Engineer

RBW/JAF/EJN

Attachments

Copies Submitted: Above (4)

Eric J. Neuner, P.E.
Manager, San Antonio Engineering



GEOTECHNICAL ENGINEERING STUDY

For

**ASH POND BERMS – SPRUCE/DEELY GENERATION UNITS
SAN ANTONIO, TEXAS**

Prepared for

PAPE-DAWSON ENGINEERS, INC.
San Antonio, Texas

Prepared by

RABA KISTNER CONSULTANTS, INC.
San Antonio, Texas

PROJECT NO. ASA12-098-00 (Revised)

May 7, 2014

TABLE OF CONTENTS

INTRODUCTION 1

PROJECT DESCRIPTION 1

RISK 1

LIMITATIONS 1

BORINGS AND LABORATORY TESTS..... 2

 pH TESTING 3

\bar{C}_u TESTS 4

 DIRECT SHEAR TESTS 4

 LIQUID DENSITY TESTS 4

 FLY ASH SPECIFIC GRAVITY TESTING 5

 MOISTURE-DENSITY TESTING..... 5

GENERAL SITE CONDITIONS..... 6

 SITE DESCRIPTION..... 6

 GEOLOGY 6

 STRATIGRAPHY 6

 GROUNDWATER 6

EARTHEN BERMS..... 7

 DESIGN CONSIDERATIONS 7

 Probable failure modes 7

 SLOPE STABILITY 8

 Minimum Factor of Safety..... 8

 Slope Configurations 9

 Method of Analysis..... 9

 Loading Conditions 10

 SOIL PARAMETERS..... 11

 Results of Analyses 12

 SEEPAGE ANALYSIS..... 13

 EARTHQUAKE ANALYSES..... 14

 Results of Quasi-Static (Seismic) Analyses 14

RESULTS 15

CONCLUSIONS..... 16

TABLE OF CONTENTS

ATTACHMENTS

Appendix A (Field Data)

Boring Location MapA-1
Logs of Borings A-2 through A-15
Key to Terms and SymbolsA-16

Appendix B (Laboratory Test Results)

Results of Soil Sample Analyses B-1
Unconfined Compression Test Reports B-2 through B-5

Appendix C (Slope Stability Analyses)

Slope Profile Locations C-1
Slope Stability and Seepage Analyses (Steady State)..... C-2 through C-15
Slope Stability and Seepage Analyses (Maximum Pool) C-16 through C-29

Appendix D (Seismic Analyses)

USGS Design Maps Summary Report D-1 and D-2
USGS Design Maps Detailed Report..... D-3 through D-11
Seismic Intensity Scales vs Peak Ground Acceleration D-12 and D-13
Slope Stability Analyses (Steady State) D-14 through D-27
Slope Stability Analyses (Maximum Pool) D-28 through D-41

INTRODUCTION

Raba Kistner Consultants Inc. (RKCI) has completed the authorized subsurface exploration and slope stability analyses for the existing ash pond berms at the Spruce/Deely Generation Units in San Antonio, Texas. This report briefly describes the procedures utilized during this study and presents our findings along with our recommendations for maintaining the existing ash pond berms.

PROJECT DESCRIPTION

The structures being considered in this study include the existing ash pond berms located at the Spruce/Deely Generation Units, which is operated by CPS Energy. Specifically, three ponds were studied and are denoted on the Boring Location Map, Figure 1. Our understanding of the slope profile at each berm, as well as the existing site topography, is based on several drawings provided to us on September 14, November 1, 2012, and May 6, 2014 by Mr. Steven Dean, P.E., with Pape-Dawson Engineers, Inc.

RISK

The geotechnical engineering recommendations contained in this memorandum are intended to provide Pape-Dawson Engineers, Inc; CPS Energy; and the U.S. Environmental Protection Agency with information pertaining to the stability of the existing ash pond berms at the Spruce/Deely Generation Units .

The geotechnical properties of the soils encountered in this study involve variability. This variability includes some spatial variability; however, the spatial variability appears to occur over relatively short distances. It is important to note that berms differ from other types of structures, such as drilled piers or driven piles, in that the performance of the berm involves local, not average, soil conditions.¹ The selection of analysis parameters for this project was based on a review of the available geotechnical data, our knowledge of the project area, and design calculations using select surveyed geometries. The results of our analyses were then reviewed with respect to important trends and general concepts, keeping these conditions and limitations in mind. Our conceptual recommendations are based on a conservative approach as is warranted for all slope stability analyses. We believe that the combination of observed conditions and probable failure modes justifies this approach.

LIMITATIONS

This engineering report has been prepared in accordance with accepted Geotechnical Engineering practices in the region of south/central Texas and for the use of Pape-Dawson Engineers, Inc. (CLIENT) and its representatives for design purposes. This report may not contain sufficient information for purposes of other parties or other uses. This report is not intended for use in determining construction means and methods.

¹ Focht, J.A. Jr. and Focht, J.A. III, "Factor of Safety and Reliability in Geotechnical Engineering, Discussion and Closure", ASCE JGGE Vol. 127 No. 8, pp.700-721, August 2001.

The recommendations submitted in this report are based on the data obtained from 14 borings drilled at this site and our understanding of the project information provided to us. If the project information described in this report is incorrect, is altered, or if new information is available, we should be retained to review and modify our recommendations.

This report may not reflect the actual variations of the subsurface conditions across the site. However, it is important to note that a significant portion of the apparent site variability is due to variation in the proportions of sand and clay in the native soils. These variations cause the soil classification to change between borings, while our experience indicates the behavior of these soils varies within a relatively narrow range.

The scope of our Geotechnical Engineering Study does not include an environmental assessment of the air, soil, rock, or water conditions either on or adjacent to the site. No environmental opinions are presented in this report.

BORINGS AND LABORATORY TESTS

Subsurface conditions at the site were evaluated by 14 borings drilled at the locations shown on the Boring Location Map, Figure A-1. These locations are approximate and distances were measured using a recreational-grade, hand-held GPS locator; tape; angles; pacing; etc. Ground surface elevations were estimated from the topography depicted on the above-referenced drawings provided by Mr. Dean. The estimated ground surface elevation at each of the boring locations is listed in the table below as well as the approximate bottom elevation of each boring.

Boring No.	Ground Surface Elevation (ft, MSL)	Boring Bottom Elevation (ft, MSL)
B-1	522	472
B-2	523	473
B-3	522	472
B-4	523	473
B-5	501	461
B-6	500	460
B-7	500	470
B-8	501	461
B-9	499	469
B-10	496	456
B-11	496	466
B-12	500	470
B-13	496	456
B-14	501	461

The borings were drilled using a truck-mounted drilling rig. During drilling operations, the following samples were collected:

Type of Sample	Number Collected
Split-Spoon (with Standard Penetration Test)	126
Undisturbed Shelby Tube	28

Each sample was visually classified in the laboratory by a member of our Geotechnical Engineering staff. The geotechnical engineering properties of the strata were evaluated by the following tests:

Type of Test	Number Conducted
Natural Moisture Content	151
Atterberg Limits	29
Percent Passing a No. 200 Sieve	33
Direct Shear	2
Consolidated-Undrained ($\bar{C}U$) Triaxial	10
Unconfined Compression	17
Dry Unit Weight	17

With the exception of the $\bar{C}U$ triaxial and direct shear tests, the results of the field and laboratory tests are presented in graphical or numerical form on the boring logs illustrated on Figures A-2 through A-15. A key to classification terms and symbols used on the logs is presented on Figure A-16. The results of the laboratory and field testing are also tabulated on Figure B-1 for ease of reference.

Standard penetration test results are noted as “blows per ft” on the boring logs and Figure B-1, where “blows per ft” refers to the number of blows by a falling hammer required for 1 ft of penetration into the soil/weak rock. Where hard or dense materials were encountered, the tests were terminated at 50 blows even if one foot of penetration had not been achieved. When all 50 blows fall within the first 6 in. (seating blows), refusal “ref” for 6 in. or less will be noted on the boring logs and on Figure B-1.

Samples will be retained in our laboratory for 30 days after submittal of this report. Other arrangements may be provided at the request of the Client.

pH TESTING

Seepage from the ash ponds would most likely result in an increase pH in the embankment soils. As a part of our laboratory study, we evaluated the collected soil samples using a phenolphthalein solution. We customarily screen for pH in order to prevent chemical burns to our laboratory staff, who typically work with the samples bare-handed.

No reaction to the phenolphthalein solution was noted in any of the samples tested. This would indicate that all samples tested had a pH value of less than 8.

C_u TESTS

Multi-stage \bar{C}_u tests were used to measure both total and effective soil strength parameters of harvested samples from the project site. During \bar{C}_u testing, each stage was subjected to a range of effective consolidation pressure.

The following table presents the results of our multi-stage \bar{C}_u tests:

Boring No.	Depth (ft)*	Effective		Total		Stress Path	
		Friction Angle, ϕ' (degrees)	Cohesion, c' (psf)	Friction Angle, ϕ (degrees)	Cohesion, c (psf)	Friction Angle, ϕ (degrees)	Cohesion, c (psf)
B-2	13-15	18.6	1,350	20.2	1,390	19.1	1,310
B-3	18-20	21.7	1,130	22.7	1,220	25.9	1,060
B-5	8-10	28.0	730	30.0	1,020	29.5	720
B-7	8-10	28.3	2,040	-	-	36.2	560
B-9	8-10	33.6	0.0	38.6	0.0	24.0	1,070
B-12	8-10	27.2	1,160	34.9	1,090	31.3	860

*Depth below the top of berm surface elevation existing at the time of our field study.

DIRECT SHEAR TESTS

Direct shear tests were performed on two samples collected during drilling operations. The results of these tests are presented in the table below:

Boring No.	Depth (ft)	Apparent Cohesion (psf)	Phi (degrees)
B-3	28.5 - 30	62	27
B-5	38.5 - 40	72	34

LIQUID DENSITY TESTS

Three one-gallon liquid samples were collected at the site on April 22, 2014. These samples were collected from the Evaporation Pond, North Bottom Ash Pond, and the North SRH Pond. The densities of these liquids are presented in the following table:

Sample Location	Density (pcf)
Evaporation Pond	61.0
North Bottom Ash Pond	60.6

Sample Location	Density (pcf)
North SRH Pond	60.7

FLY ASH SPECIFIC GRAVITY TESTING

Two samples of fly ash sludge were collected at the site on April 22, 2014 to calculate the specific gravity of the fly ash. The calculated specific gravities are presented in the table below:

Sample Location	Specific Gravity
North Bottom Ash Pond	2.59
South Bottom Ash Pond	2.60

MOISTURE-DENSITY TESTING

The density of the at surface material in the dry portions of the ponds was measured on April 22, 2014 using a nuclear density gauge. The results of these tests are presented in the tables below:

Pond	Sample Location	Wet Density (pcf)	Moisture Content (%)	Dry Density (pcf)
Evaporation Pond	West Edge of Pond	94.2	33.3	70.7
		92.9	40.0	66.4
		92.0	31.1	70.2
		95.2	31.5	72.4
		92.6	35.5	68.4
		94.4	34.5	70.2
North Bottom Ash Pond	East and Southeast Edge of Pond	106.3	18.0	90.1
		111.2	19.0	93.4
		107.3	24.2	86.4
		112.9	17.9	95.8
		110.7	21.5	91.1
		107.6	24.9	86.2
South Bottom Ash Pond	Center of Pond	118.0	18.0	100.0
		122.2	16.3	105.1
		119.5	16.2	102.9
		114.6	19.2	96.2
		106.7	23.6	86.4
		115.5	17.7	98.1

GENERAL SITE CONDITIONS

SITE DESCRIPTION

The project site is a tract of developed land located at the Spruce/Deely Generation Units , which is operated by CPS Energy. The ash ponds considered in this study are located east and northeast of the existing main power plant facility. The entire facility is bounded to the west, south, and east by Calaveras Lake. The topography generally slopes downward toward Calaveras Lake. CPS maintains the Calaveras Lake at a target pool elevation of Elevation 485 feet with periodic fluctuations of plus or minus one foot. Levels above the target pool elevation are usually due to rainfall in the Calaveras Creek, Hondo Creek and Chupaderas Creek watersheds, and typically return to the target pool elevation within a few days of the rain event.

GEOLOGY

A review of the *Geologic Atlas of Texas, San Antonio Sheet*, indicates that this site is naturally underlain with the soils/rocks of the Wilcox Group, which is composed of mudstone with varying amounts of sandstone and lignite. The Wilcox Group may weather to yellowish-brown clay, sandy clay, clayey sands, and sands.

The Wilcox Group grades downward into the Midway Group, which is composed of clay, silt, and sand, with some pebbles near its base. Glauconite is often encountered in these soils. Key engineering considerations for development supported on the soils/rock of this formation typically include the presence of possible water-bearing layers, very hard mudstone/sandstone layers, and the expansive nature of the highly plasticity clays that can be present in this formation.

STRATIGRAPHY

The subsurface stratigraphy at this site varies from pond to pond, and berm to berm. However, the embankment fill soils typically consist of sandy clay or clayey sand. It is difficult to distinguish between these two soil types in the berms because the percent passing a No. 200 sieve ranges within about 10 percentage points higher and lower than 50%. The subgrade stratigraphy is also generally composed of interbedded sandy clay and clayey sand. There were also isolated tan and gray clay seams encountered in our borings. Each stratum has been designated by grouping soils that possess similar physical and engineering characteristics. The boring logs should be consulted for more specific stratigraphic information. The lines designating the interfaces between strata on the boring logs represent approximate boundaries. Transitions between strata may be gradual, which vary within a relatively narrow combined range of Plasticity Index and -200 values.

GROUNDWATER

The depth to groundwater was measured in all borings except Boring B-1. The groundwater level in Boring B-1 could not be measured due to the introduction of drilling fluids in this boring.

Upon completion of the drilling operations, groundwater levels ranged from 11 to 17 ft below the existing ground surface in the borings drilled for Ponds 1 and 2. Groundwater levels ranged from 40 to 42 ft below the existing ground surface in the borings drilled for Pond 3 (with the exception of Boring B-1).

As mentioned previously, this site is bounded to the west, south, and east by Calaveras Lake. The groundwater levels encountered at this site are most likely dominated by the surface water elevation of Calaveras Lake. Fluctuations in groundwater levels are possible due to variations in rainfall and surface water run-off.

EARTHEN BERMS

DESIGN CONSIDERATIONS

The existing berms should meet three important criteria: they should be resistant to the forces of erosion, should exhibit a suitable slope stability design allowable factor of safety with respect to long-term, short-term, and sudden drawdown conditions, as well as performance type scenarios such as underseepage. The berm structure must meet these criteria so that the calculated risk of failure is consistent with criteria established by the USACE guidelines.

Probable failure modes

Our review of the site and expected conditions for the Calaveras Power Plant ash ponds indicates that the following major modes of failure could affect the berms:

- Slope stability
- Underseepage
- Embankment Seepage

The following sections address each of these failure modes, as well as slope erosion and liquefaction.

Slope Stability Based on our review of available data and our visual observations during drilling, the existing embankments exhibit slopes ranging from about 3:1 (horizontal:vertical) or flatter, while a few limited areas exhibit slopes of about 2.5:1.

In general, slopes flatter than 3:1 would be expected to exhibit the required factors of safety for a normal (non-flood) seepage condition with the area water table near Elevation 485 feet.

Underseepage We generally consider underseepage to be a very low risk for the existing berms. Underseepage consists of water flowing beneath the embankment as a result of water seeping out of the ash ponds. The principal failure mechanism related to underseepage occurs when the upward force of the water equals or exceeds the buoyant weight of the soil. This does not appear likely to occur at this project site.

Berm Seepage Embankment seepage consists of water flowing through the berm as a result of seepage through the berm. The principal failure mechanism related to embankment seepage occurs when the horizontal force of the water equals or exceeds the effective shear strength of the soil. This mode of failure is not expected to occur at this project site.

Slope Erosion The existing embankments are generally composed of cohesive soils, while the underlying soils are generally composed of cohesive soils with layers semi-cohesive soils. It appears that the existing embankments were constructed using the soils available at the project site. These materials are generally considered acceptable to good materials to use when constructing berms, dams and slopes. In addition, the berms are not expected to be exposed to flowing water, other than rain that falls on the berm crest and berm slopes. The risk of berm failure due to erosion is considered to be very low.

Liquefaction Soil liquefaction results from loss of strength during cyclic loading, such as imposed by earthquakes. Soils most susceptible to liquefaction are clean, loose, saturated, uniformly graded, and fine-grained sands. Empirical evidence indicates that loose silty sands are also potentially liquefiable. When seismic ground shaking occurs, the soil is subjected to cyclic shear stresses that can cause excess hydrostatic pressures to develop. If excess hydrostatic pressures reach the effective confining stress from the overlying soil, the sand may undergo deformations. If the sand undergoes virtually unlimited deformation without developing significant resistance, it is said to have liquefied, and if the sand consolidates or vents to the surface during and following liquefaction, ground settlement may occur.

The soils contain significant quantities of clay, and are relatively dense. Even when groundwater is present, the berms have a very low potential for liquefaction during earthquake events, particularly since the USGS online resources indicate there is less than 0.1 percent chance of experiencing a magnitude 5.0 or greater earthquake at this site during a 50 year period. In addition, calculations performed using the Seed and Idriss method indicate the most susceptible tested sample must experience a ground acceleration in excess of 0.44g before liquefaction will occur. Based on these findings, RKCI believes the soils beneath the existing berms have a very low risk of experiencing liquefaction due to an earthquake.

SLOPE STABILITY

This section presents our slope stability analyses performed for this study. In general, the procedures described in USACE EM 1110-2-1902 *Slope Stability* were followed. As such, our analysis focused on embankment stability, settlement, interior drainage, and slope protection.

The slope configurations analyzed, method of analysis, loading conditions, and soil properties used in the analyses are discussed in the following paragraphs.

Minimum Factor of Safety

For a given slope configuration, the forces that “drive” slope failure (including gravity, groundwater seepage pressure, and possible excess pore water pressures from external loading conditions) are compared to the slope’s resistance to failure, which is a function of dewatering controls and internal shear strength (cohesion and internal angle of friction) of both the foundation soils and the fill soils utilized for construction of the embankment.

The USACE has specified minimum safety factors against slope failure with respect to loading conditions. The minimum acceptable factors of safety for berms at end of construction, rapid drawdown, and steady state conditions, provided in Table 3-1 on Page 3-2 of EM 1110-2-1902, are listed in the following table. The minimum safety factor against slope failure during an earthquake is customarily assumed to be a calculated value greater than 1.0 where the risk of loss of life is low and the structure is not deemed critical in nature (hospitals, emergency services, etc.)

Condition	Required Factor of Safety
End of Construction	1.3
Sudden Drawdown	1.1 to 1.3
Long Term (Steady Seepage)	1.4
Earthquake	Greater than 1.0

We consider a significant slope failure to involve a volume of slope material that is large enough to substantially impair the serviceability or operation of the berm or that could imperil human life. Shallow, sloughing slope failures that involve relatively little material or that can be repaired locally without substantially impacting the ash pond operations are considered to be minor slope failures and do not control the conclusions of our stability analyses.

Slope Configurations

At the time this technical report was prepared, field surveys drawings of the existing berms had been performed by Pape Dawson Engineers, Inc. As a part of their work, we understand that Pape Dawson spot-checked the existing berms, and only provided surveyed cross-sections where the existing condition did not closely resemble the original drawings. As such, we have provided the original design geometry for the purposes of our study for the select berms. Figure C-1 shows the profiles that were surveyed and those that are based on the design drawings.

We recognized four general soil conditions along the length of the alignment that may be considered as worst-case boundary conditions. As such, four cases were analyzed based on these boundary conditions.

Method of Analysis

The slope stability analyses for this study were conducted with the aid of a computer using the program SLIDE developed by RocScience. The SLIDE computer program randomly generates trial failure surfaces and evaluates the factor of safety for each trial surface. The program allows a large number of potential shear surfaces to be investigated to determine the critical failure surface for each of the analyzed slope configurations.

The portions of the program used in this study employed both the Morgenstern-Price and Spencer computational methods. These methods were used to make calculations of the stability of slopes where non-circular failure surfaces were permitted. In each case, the computed factor of safety is the ratio of the forces resisting movement to the driving forces. A factor of safety of 1.0 or less implies the slope is unstable, while a factor of safety greater than 1.0 implies the slope is stable.

Loading Conditions

For satisfactory performance, an earth embankment should have an acceptable factor of safety during construction and throughout its projected service lifetime. Stability analyses should include variations in stress conditions brought on by construction practices and sequencing, external loadings, and any anticipated changes in hydraulic conditions. The following paragraphs discuss each stability condition analyzed in our study.

External Loads External loads for the roadways along the berm crest have also been modeled. A traffic loading of HS20 (modeled as an equivalent uniform surcharge of 100 psf) was applied to the crest of the berm.

Liquid/Sludge Loads Based on the results of the density testing performed on the samples collected on April 22, 2014, we have included additional loads on the analyses conducted for the “dry side” of the berms.

These loads account for the increase in pressure in the bottom of the ponds and along the berm slopes due to weight of the sludge and/or liquid in the ponds. The increase in the pressure due to this material is modeled in our analysis.

These loads were not applied to the “pond side” analyses due to the increase in factors of safety from this loading condition.

End of Construction The short-term (undrained) loading condition models the slope immediately following construction. For this loading condition, the pore pressures developed during construction have not had the opportunity to dissipate. We did not analyze this condition since the berms have been in place for many years.

Steady State Seepage The long term (drained), steady-state seepage loading condition was analyzed. This loading condition models the ash ponds with 2 ft of freeboard along the berm crest and assumes that the berm soils are fully saturated and a condition of steady state seepage occurs through the embankment. For this loading condition, effective stress soil parameters were used in the analysis.

Maximum Pool The analyses for “Maximum Pool” consider those given for “Steady State” but assume that the pond is completely full.

The maximum pool condition represents a more severe condition than an assumed steady state analysis with the pond level 2 ft below the top of the embankment. Provided the analyses meet the

relevant criteria for slope stability and seepage, a separate steady state analysis for normal operating conditions is not required.

Sudden Drawdown from Design Flood Stage This condition represents the situation when the water within the pond is drained at such a rapid rate that the saturated berm soils do not have time to drain. Consequently, excess pore water pressures result in the soil. We did not model this condition since it would pose no risk of environmental contamination, because the pond must be empty for this condition to occur.

SOIL PARAMETERS

Drained soil parameters (drained cohesion and drained friction angle) were selected for each soil stratum based on the laboratory and field test data collected during our study as well as correlations published by Stark and Hussain (2010)². The fully softened soil strength envelopes were compared to the stress path strength envelopes developed from the $\bar{C}U$ tests performed for this study. With the possible exception of the multi-stage $\bar{C}U$ test performed on a sandy clay sample harvested from Boring B-2 at 13 to 15 feet, all of the stress path strength envelopes developed from the $\bar{C}U$ tests exceeded the Stark and Hussain fully softened soil strength envelopes. We assumed that soil behavior was represented by the fully softened soil condition, and also evaluated Profile D using both the relevant fully softened soil strength envelope and the stress path strength envelope developed from the referenced $\bar{C}U$ test. We did not employ the residual strength soil properties since we found no evidence of pre-existing failure surfaces, and are unaware of any prior slope failures in the berm slopes. For purposes of our slope stability analyses, we have assigned the material properties presented in the following table.

Drained Fully Softened Shear Stresses from Equations Developed by Stark and Hussain (2010)

North and South SRH Ponds	Clay Fraction %	Assumed Liquid Limit	Normal Stress, psf				Equivalent Upper-Bound Soil Parameters	
			0	1,044	2,089	8,354	c (psf)	Phi (degrees)
Embankment Soil (CL)	47	42	0	647	1,158	4,075	186	25.0
Sandy Clay (CL)	52	52	0	561	972	3,281	202	20.2
Clayey Sand (ML)	36	33	0	669	1,197	4,240	183	25.9

² Stark, T.D. and M. Hussain, "Shear Strength in Pre-existing Landslides," *Journal of Geotechnical and Geoenvironmental Engineering*, ASCE, 136(7), July, 2010, pp. 957-962.

North and South Bottom Ash Ponds	Clay Fraction %	Assumed Liquid Limit	Normal Stress, psf				Equivalent Upper-Bound Soil Parameters	
			0	1,044	2,089	8,354	c (psf)	Phi (degrees)
Embankment Soil (CL)	45	35	0	664	1,188	4,202	184	25.7
Sandy Clay (CL)	61	51	0	563	976	3,298	202	20.3
Clayey Sand (ML)	43	33	0	669	1,197	4,240	183	25.9

Evaporation Pond	Clay Fraction %	Assumed Liquid Limit	Normal Stress, psf				Equivalent Upper-Bound Soil Parameters	
			0	1,044	2,089	8,354	c (psf)	Phi (degrees)
Embankment Soil (CL)	45	45	0	640	1,145	4,023	186	24.7
Sandy Clay (CL)	50	54	0	557	963	3,247	202	20.0
Clayey Sand (ML)	34	55	0	618	1,105	3,859	187	23.7

The tables obtained from Stark and Hussain can be used to estimate equivalent c-phi linear shear strength parameters that have been traditionally used in slope stability analyses. These values are also tabulated in the three tables presented above. Please note that the c-phi values tend to overestimate the available soil shear strength at low overburden pressures. The Stark and Hussain values correctly predict the likelihood of shallow surface sloughs for clay soils, but the calculated results for the deeper failures contemplated in this study should be essentially the same using either soil model.

Results of Analyses

The following table contains a summary of the results from our slope stability analyses for each loading condition and slope configuration. In general, the point where a potential slide surface was permitted to intersect was not allowed to occur within 3 ft of the relevant top of slope. This limitation was intended to reduce the occurrence of “non-critical” failure surfaces from resulting from the analyses. A graphical presentation of the most critical failure surface from our SLIDE iterations for each berm profile studied can be found at the end of this memorandum in Appendix C. The “a” series figures show the critical failure surface on the “dry side” of each berm, while the “b” series figures show the critical failure surface on the “pond side” of each berm.

Computed Factors of Safety for North and South SRH Ponds					
Slope Profile	End of Construction	Steady State on Pond Side	Steady State on Dry Side	Maximum Pool on Pond Side	Maximum Pool on Dry Side
J	N/A	> 2	> 2	> 2	> 2
K	N/A	> 2	> 2	> 2	> 2
L	N/A	> 2	> 2	> 2	> 2
M	N/A	> 2	1.7	> 2	1.6

Computed Factors of Safety for North and South Bottom Ash Ponds					
Slope Profile	End of Construction	Steady State on Pond Side	Steady State on Dry Side	Maximum Pool on Pond Side	Maximum Pool on Dry Side
E	N/A	> 2	> 2	> 2	> 2
F	N/A	> 2	> 2	> 2	> 2
G	N/A	1.8	1.3	> 2	1.4
H	N/A	> 2	> 2	> 2	> 2
I	N/A	1.8	1.6	> 2	1.5
N	N/A	1.9	1.6	> 2	1.6

Computed Factors of Safety for the Evaporation Pond					
Slope Profile	End of Construction	Steady State on Pond Side	Steady State on Dry Side	Maximum Pool on Pond Side	Maximum Pool on Dry Side
A	N/A	2	> 2	> 2	> 2
B	N/A	> 2	> 2	> 2	> 2
C	N/A	> 2	1.5	> 2	> 2
D	N/A	> 2	1.9	> 2	> 2

SEEPAGE ANALYSIS

We performed steady-state seepage analyses for each slope profile using the finite element groundwater module within SLIDE. Our seepage analyses were performed assuming that the soil properties observed in our borings exhibited a 5:1 ratio of permeability (horizontal:vertical) with the assumed permeability values presented in the following table.

Soil	Assumed Permeability, cm/second	
	Horizontal	Vertical
Clay	1×10^{-7}	2×10^{-8}
Sandy Clay	1×10^{-6}	2×10^{-7}
Clayey Sand	1×10^{-4}	2×10^{-5}

EARTHQUAKE ANALYSES

Each berm profile was also evaluated for earthquake conditions utilizing a design spectral acceleration of 0.098g. The assumed seismic force was calculated using the USGS web site calculator; in general, these analyses are considered to be very conservative since the nearest documented active fault is roughly 385 miles from the project site. A probabilistic assessment of the likelihood of the project site experiencing a magnitude 5 or larger earthquake within a 50 year period was also performed. This assessment indicated that the probability of occurrence was only 4 to 6 percent, which is considerably less than the 10 percent required by USEPA regulations. Graphical representations of these analyses are presented in Appendix D. The “a” series figures show the critical failure surface on the “dry side” of each berm, while the “b” series figures show the critical failure surface on the “pond side” of each berm.

Quasi-static analyses were performed, with soil behavior modeled using total stress soil strength values. The assumed values of shear strength used in our models consisted of both a cohesion intercept and angle of internal friction, with the cohesion intercept values chosen based on the unconfined compressive strength testing performed for this study as well as prior area experience. The strength values chosen are considered lower bound for the soils encountered at the project site.

The soil properties utilized for these analyses are presented in the following table:

Material	Unit Weight (pcf)	Cohesion (psf)	Phi (degrees)
Embankment Fill	120	350	20
Clayey Sand	120	400	20
Clayey Sand Below Water Table	57.6	400	20
Sandy Clay	120	500	20
Sandy Clay Below Water Table	57.6	500	20

Results of Quasi-Static (Seismic) Analyses

Global stability analyses were also performed for each slope analyzed for steady state conditions. The results of our analyses are summarized below and are graphically presented in Appendix D at the end of this report.

Computed Factors of Safety for North and South SRH Ponds					
Slope Profile	End of Construction	Steady State on Pond Side	Steady State on Dry Side	Maximum Pool on Pond Side	Maximum Pool on Dry Side
J	N/A	> 2	> 2	> 2	> 2
K	N/A	> 2	> 2	> 2	> 2
L	N/A	> 2	> 2	> 2	> 2
M	N/A	> 2	1.7	> 2	1.6

Computed Factors of Safety for North and South Bottom Ash Ponds					
Slope Profile	End of Construction	Steady State on Pond Side	Steady State on Dry Side	Maximum Pool on Pond Side	Maximum Pool on Dry Side
E	N/A	> 2	> 2	> 2	> 2
F	N/A	> 2	> 2	> 2	> 2
G	N/A	> 2	1.9	> 2	1.9
H	N/A	> 2	> 2	> 2	> 2
I	N/A	> 2	> 2	> 2	> 2
N	N/A	> 2	> 2	> 2	> 2

Computed Factors of Safety for the Evaporation Pond					
Slope Profile	End of Construction	Steady State on Pond Side	Steady State on Dry Side	Maximum Pool on Pond Side	Maximum Pool on Dry Side
A	N/A	> 2	> 2	> 2	> 2
B	N/A	> 2	> 2	> 2	> 2
C	N/A	> 2	1.5	> 2	> 2
D	N/A	> 2	1.9	> 2	> 2

RESULTS

In general, the global stability analyses for steady state conditions resulted in calculated factors of safety in excess of 2 for both long term and earthquake conditions. Three sections exhibited calculated factors of safety of less than 2, and one section (“G”) exhibited a calculated factor of safety of 1.2 for the “dry” slope. Review of Figure C-8a revealed that the critical failure surface for this analysis was relatively thin and did not appear to threaten the ash pond reservoir. A second analysis of this section was then performed, with the top of the assumed surfaces limited to intersecting the ground surface at the top of slope of the “wet” slope or farther from the “dry” slope. Surfaces in this portion of the berm would not threaten containment

of the ash pond's contents. The results of this analysis are presented on Figure C-8c, and indicate the calculated factor of safety for this analysis was 1.4.

Global stability analyses for the assumed earthquake conditions resulted in calculated factors of safety that exceeded 1.5 in the evaluated cases. These results indicate that pond failures due to seismic forces do not pose a significant threat to the ash ponds at this site.

CONCLUSIONS

The existing berms were constructed of lean sandy clays and/or clayey sands over competent sandy clays and clayey sands. Liquefaction is considered a very low risk issue at this site. The results of our seepage analyses indicate that no significant risk of an erosion or piping-type failure beneath the ash pond embankments exists. The results of our earthquake analyses indicate that no significant risk of embankment failure due to seismic forces exists at this site. Global stability analyses of steady state conditions indicate that acceptable calculated factors of safety were obtained for reasonable failure surfaces through the embankments at this site, even though the analyses were performed using fully softened soil strength envelopes that were lower than \overline{CU} tests indicate are available at the project site.

The end-of-construction condition was not evaluated due to the age of the ash ponds, and both rapid drawdown and erosion failures are considered to be of very low risk due to the embankment toe elevations (above EL 490 feet) with respect to the target pool elevation (EL 485 feet). We do not consider embankment seepage or underseepage to pose a significant risk to the berm based on both the long-term performance of the berms and the results of the seepage analyses, which was indirectly confirmed by the pH testing performed on all of the harvested soil samples. The results of our slope stability analyses indicate that all of the berm slopes meet or exceed both USEPA and USACE criteria for stability under steady state (long term) and seismic (earthquake) conditions.

* * * * *

The following appendices are attached and complete this report:

- | | |
|--------------------------|------------|
| Field Data | Appendix A |
| Laboratory Test Results | Appendix B |
| Slope Stability Analyses | Appendix C |
| Seismic Analyses | Appendix D |

ATTACHMENTS

APPENDIX A

FIELD DATA

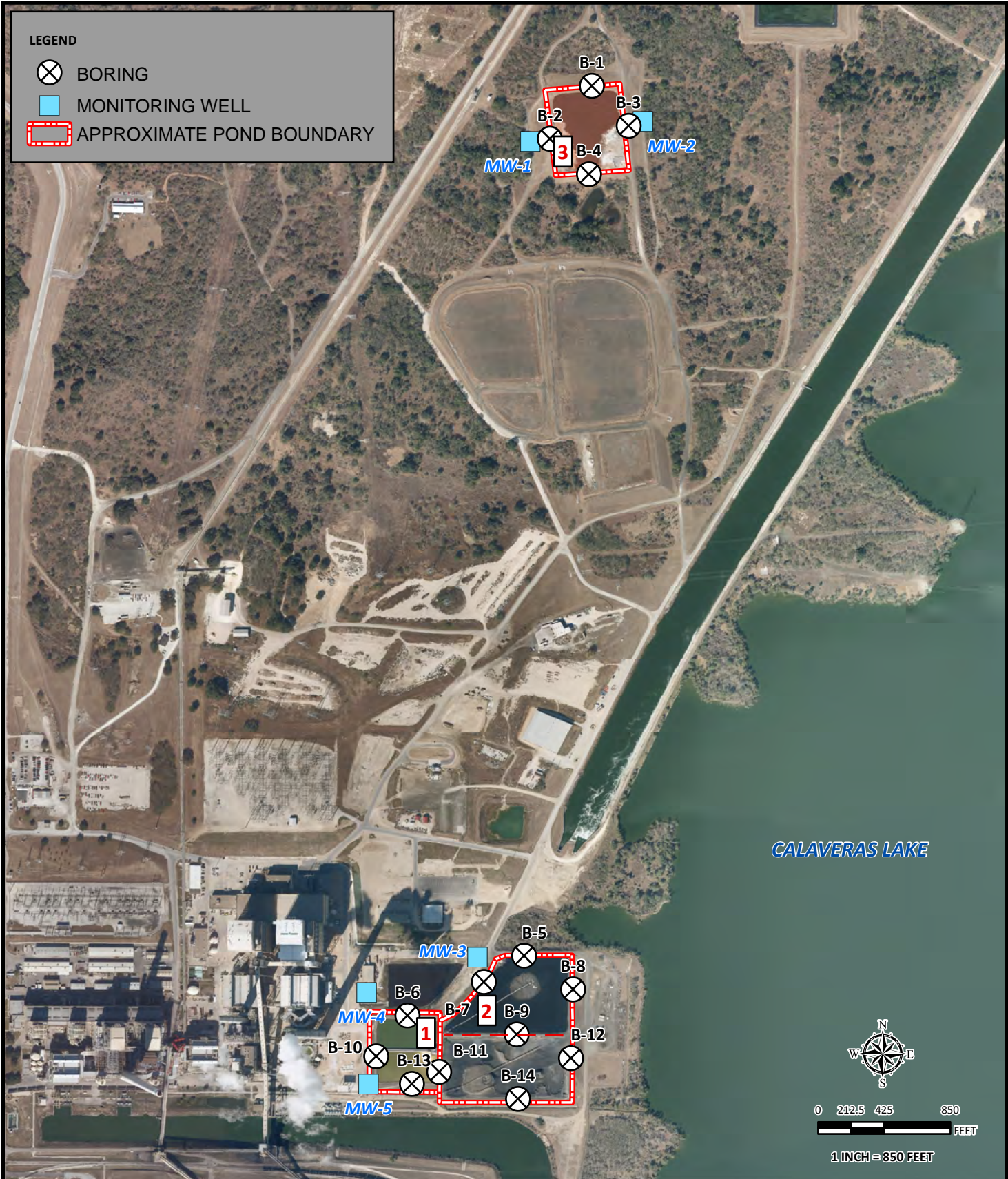

Raba Kistner Consultants, Inc.
 12821 West Golden Lane
 San Antonio, Texas 78249
 P 210 :: 699 :: 9090
 F 210 :: 699 :: 6426
 www.rkci.com
 TBPE Firm Number 3257

SOURCE: 2011 Aerial Photograph Provided by the City of San Antonio (COSA)

BORING & MONITORING WELL LOCATION MAP

ASH POND BERMS - SPRUCE/DEELY GENERATION UNITS
 SAN ANTONIO, TEXAS

REVISIONS:
 No. DATE DESCRIPTION

No.	DATE	DESCRIPTION

PROJECT No.:	ASA12-098-00
ISSUE DATE:	10/10/2012
DRAWN BY:	CCL
CHECKED BY:	RBW
REVIEWED BY:	GLB

FIGURE
A-1

LOG OF BORING NO. B-1

Ash Pond Berms - Spruce/Deely Generation Units
San Antonio, Texas



DRILLING METHOD: Straight Flight Auger

LOCATION: N 29.32477; W 98.31464

DEPTH, FT	SYMBOL	SAMPLES	DESCRIPTION OF MATERIAL	BLOWS PER FT	UNIT DRY WEIGHT, pcf	SHEAR STRENGTH, TONS/FT ²			PLASTICITY INDEX	% -200
						0.5	1.0	1.5		
SURFACE ELEVATION: 522 ft										
			BASE MATERIAL (6 in.)	11						
			FILL MATERIAL: SAND, Medium Dense, Tan							
			FILL MATERIAL: CLAY, Sandy, Firm, Reddish-Tan, with gray mottling	7						50
5					106					16
					110					
10			SAND, Clayey, Medium Dense to Very Dense, Tan to Gray		112					40
15			-with a tan and gray clay seam from 13 to 15 ft	16						37
			-switched to mud rotary at 15 ft							
20				22						
25				50/11"						
30				50/11"						43
35				49						
				50/11"						
DEPTH DRILLED:		49.7 ft		DEPTH TO WATER:		N/A		PROJ. No.:		ASA12-098-00
DATE DRILLED:		10/15/2012		DATE MEASURED:		10/15/2012		FIGURE:		A-2a

NOTE: THESE LOGS SHOULD NOT BE USED SEPARATELY FROM THE PROJECT REPORT

LOG OF BORING NO. B-1
 Ash Pond Berms - Spruce/Deely Generation Units
 San Antonio, Texas



DRILLING METHOD: Straight Flight Auger

LOCATION: N 29.32477; W 98.31464

DEPTH, FT	SYMBOL	SAMPLES	DESCRIPTION OF MATERIAL	BLOWS PER FT	UNIT DRY WEIGHT, pcf	SHEAR STRENGTH, TONS/FT ²							PLASTICITY INDEX	% -200	
						0.5	1.0	1.5	2.0	2.5	3.0	3.5			4.0
			SURFACE ELEVATION: 522 ft												
			SAND, Clayey, Medium Dense to Very Dense, Tan to Gray (continued)												
45		X		50/9"											
50		X		50/8"											
55															
60															
65															
70															
75															
DEPTH DRILLED: 49.7 ft			DEPTH TO WATER: N/A			PROJ. No.: ASA12-098-00									
DATE DRILLED: 10/15/2012			DATE MEASURED: 10/15/2012			FIGURE: A-2b									

NOTE: THESE LOGS SHOULD NOT BE USED SEPARATELY FROM THE PROJECT REPORT

LOG OF BORING NO. B-2

Ash Pond Berms - Spruce/Deely Generation Units
San Antonio, Texas



DRILLING METHOD: Straight Flight Auger

LOCATION: N 29.32378; W 98.31541

DEPTH, FT	SYMBOL	SAMPLES	DESCRIPTION OF MATERIAL	BLOWS PER FT	UNIT DRY WEIGHT, pcf	SHEAR STRENGTH, TONS/FT ²					PLASTICITY INDEX	% -200			
						0.5	1.0	1.5	2.0	2.5			3.0	3.5	4.0
						PLASTIC LIMIT		WATER CONTENT					LIQUID LIMIT		
			SURFACE ELEVATION: 523 ft			10	20	30	40	50	60	70	80		
			FILL MATERIAL: CLAY, Sandy, Stiff, Brown	11											
			FILL MATERIAL: SAND, Clayey, Brown and Tan												
5														15	
			CLAY, Sandy, Very Stiff, Tan and Gray												
10															
														36	
15															
			SAND, Clayey, Dense to Very Dense, Gray												
20															
				50/11"											24
25															
				50/10"											
30															
				38											
35															
				50											

NOTE: THESE LOGS SHOULD NOT BE USED SEPARATELY FROM THE PROJECT REPORT

DEPTH DRILLED: 49.8 ft	DEPTH TO WATER: 40 ft	PROJ. No.: ASA12-098-00	
DATE DRILLED: 10/16/2012	DATE MEASURED: 10/16/2012	FIGURE: A-3a	

LOG OF BORING NO. B-2
 Ash Pond Berms - Spruce/Deely Generation Units
 San Antonio, Texas



DRILLING METHOD: Straight Flight Auger

LOCATION: N 29.32378; W 98.31541

DEPTH, FT	SYMBOL	SAMPLES	DESCRIPTION OF MATERIAL	BLOWS PER FT	UNIT DRY WEIGHT, pcf	SHEAR STRENGTH, TONS/FT ²						PLASTICITY INDEX	% -200	
						0.5	1.0	1.5	2.0	2.5	3.0			3.5
			SURFACE ELEVATION: 523 ft											
45			SAND, Clayey, Dense to Very Dense, Gray (continued) -DRILLER'S NOTE: WATER encountered at 40 ft	50/8"										
50				50/9"										
55														
60														
65														
70														
75														
DEPTH DRILLED: 49.8 ft			DEPTH TO WATER: 40 ft			PROJ. No.: ASA12-098-00								
DATE DRILLED: 10/16/2012			DATE MEASURED: 10/16/2012			FIGURE: A-3b								

NOTE: THESE LOGS SHOULD NOT BE USED SEPARATELY FROM THE PROJECT REPORT

LOG OF BORING NO. B-3

Ash Pond Berms - Spruce/Deely Generation Units
San Antonio, Texas



DRILLING METHOD: Straight Flight Auger

LOCATION: N 29.32401; W 98.31406

DEPTH, FT	SYMBOL	SAMPLES	DESCRIPTION OF MATERIAL	BLOWS PER FT	UNIT DRY WEIGHT, pcf	SHEAR STRENGTH, TONS/FT ²				PLASTICITY INDEX	% -200	
						0.5	1.0	1.5	2.0			2.5
			SURFACE ELEVATION: 522 ft									
24			FILL MATERIAL: SAND, Medium Dense, Brown, with gravel (road material)									
12			FILL MATERIAL: SAND, Clayey, Medium Dense, Tan									
11										19		
19											41	
14			CLAY, Sandy, Stiff to Very Stiff, Tan and Gray									
112										30		
20												
46			SAND, Clayey, Dense to Very Dense, Tan to Gray									47
50												
50/11"												
50/11"												
			-DRILLER'S NOTE: WATER encountered at 39 ft									33
DEPTH DRILLED: 49.8 ft			DEPTH TO WATER: 40 ft			PROJ. No.: ASA12-098-00						
DATE DRILLED: 10/15/2012			DATE MEASURED: 10/15/2012			FIGURE: A-4a						

NOTE: THESE LOGS SHOULD NOT BE USED SEPARATELY FROM THE PROJECT REPORT

LOG OF BORING NO. B-3
 Ash Pond Berms - Spruce/Deely Generation Units
 San Antonio, Texas



DRILLING METHOD: Straight Flight Auger

LOCATION: N 29.32401; W 98.31406

DEPTH, FT	SYMBOL	SAMPLES	DESCRIPTION OF MATERIAL	BLOWS PER FT	UNIT DRY WEIGHT, pcf	SHEAR STRENGTH, TONS/FT ²						PLASTICITY INDEX	% -200	
						0.5	1.0	1.5	2.0	2.5	3.0			3.5
			SURFACE ELEVATION: 522 ft											
45			SAND, Clayey, Dense to Very Dense, Tan to Gray (continued) -with a tan and gray clay seam from 43 to 45 ft	38										
50				50/10"										
55														
60														
65														
70														
75														
DEPTH DRILLED:		49.8 ft		DEPTH TO WATER:		40 ft		PROJ. No.:		ASA12-098-00				
DATE DRILLED:		10/15/2012		DATE MEASURED:		10/15/2012		FIGURE:		A-4b				

NOTE: THESE LOGS SHOULD NOT BE USED SEPARATELY FROM THE PROJECT REPORT

LOG OF BORING NO. B-4

Ash Pond Berms - Spruce/Deely Generation Units
San Antonio, Texas



DRILLING METHOD: Straight Flight Auger

LOCATION: N 29.32322; W 98.31478

DEPTH, FT	SYMBOL	SAMPLES	DESCRIPTION OF MATERIAL	BLOWS PER FT	UNIT DRY WEIGHT, pcf	SHEAR STRENGTH, TONS/FT ²			PLASTICITY INDEX	% -200
						0.5	1.0	1.5		
SURFACE ELEVATION: 523 ft										
			FILL MATERIAL: CLAY, Sandy, Firm, Brown	7					25	
			FILL MATERIAL: CLAY, Sandy, Stiff to Very Stiff, Tan and Brown	5					54	
5				14					30	
				113						
				110						
10				26					27	
			SAND, Clayey, Dense, Brown							
15				49						
			CLAY, Very Stiff, Reddish-Tan	24						
25			SAND, Clayey, Dense to Very Dense, Tan and Gray, with intermittent clay seams							
				97					32	
30				50						
35				50/10"						

NOTE: THESE LOGS SHOULD NOT BE USED SEPARATELY FROM THE PROJECT REPORT

DEPTH DRILLED: 49.8 ft	DEPTH TO WATER: 42 ft	PROJ. No.: ASA12-098-00
DATE DRILLED: 10/16/2012	DATE MEASURED: 10/16/2012	FIGURE: A-5a

LOG OF BORING NO. B-4
 Ash Pond Berms - Spruce/Deely Generation Units
 San Antonio, Texas



DRILLING METHOD: Straight Flight Auger

LOCATION: N 29.32322; W 98.31478

DEPTH, FT	SYMBOL	SAMPLES	DESCRIPTION OF MATERIAL	BLOWS PER FT	UNIT DRY WEIGHT, pcf	SHEAR STRENGTH, TONS/FT ²						PLASTICITY INDEX	% -200
						0.5	1.0	1.5	2.0	2.5	3.0		
			SURFACE ELEVATION: 523 ft										
45			SAND, Clayey, Dense to Very Dense, Tan and Gray, with intermittent clay seams <i>(continued)</i> -DRILLER'S NOTE: WATER encountered at 42 ft	50									
50				50/9"									23
55													
60													
65													
70													
75													
DEPTH DRILLED:			49.8 ft	DEPTH TO WATER:			42 ft	PROJ. No.:			ASA12-098-00		
DATE DRILLED:			10/16/2012	DATE MEASURED:			10/16/2012	FIGURE:			A-5b		

NOTE: THESE LOGS SHOULD NOT BE USED SEPARATELY FROM THE PROJECT REPORT

LOG OF BORING NO. B-5

Ash Pond Berms - Spruce/Deely Generation Units
San Antonio, Texas



DRILLING METHOD: Straight Flight Auger

LOCATION: N 29.30947; W 98.31590

DEPTH, FT	SYMBOL	SAMPLES	DESCRIPTION OF MATERIAL	BLOWS PER FT	UNIT DRY WEIGHT, pcf	SHEAR STRENGTH, TONS/FT ²				PLASTICITY INDEX	% -200
						0.5	1.0	1.5	2.0		
			SURFACE ELEVATION: 501 ft								
5			FILL MATERIAL: SAND, Clayey, Medium Dense, Tan	17							
				21							
				24							
				20						19	
											46
			SAND, Clayey, Medium Dense to Very Dense, Gray	33							46
				50/10"							
				50/9"							
			-with a clay seam from 28-1/2 to 30 ft	24							
				50/7"							31
				50/8"							

NOTE: THESE LOGS SHOULD NOT BE USED SEPARATELY FROM THE PROJECT REPORT

DEPTH DRILLED: 39.7 ft DATE DRILLED: 10/17/2012	DEPTH TO WATER: 14 ft DATE MEASURED: 10/17/2012	PROJ. No.: ASA12-098-00 FIGURE: A-6
--	--	--

LOG OF BORING NO. B-6

Ash Pond Berms - Spruce/Deely Generation Units
San Antonio, Texas



DRILLING METHOD: Straight Flight Auger

LOCATION: N 29.30837; W 98.31790

DEPTH, FT	SYMBOL	SAMPLES	DESCRIPTION OF MATERIAL	BLOWS PER FT	UNIT DRY WEIGHT, pcf	SHEAR STRENGTH, TONS/FT ²			PLASTICITY INDEX	% -200					
						0.5	1.0	1.5			2.0	2.5	3.0	3.5	4.0
						PLASTIC LIMIT									
						WATER CONTENT									
						LIQUID LIMIT									
			SURFACE ELEVATION: 500 ft			10	20	30	40	50	60	70	80		
5			FILL MATERIAL: CLAY, Sandy, Stiff to Very Stiff, Tan	15											
				14										15	
				24										50	
				19											
				21											
10			GRAVEL, Tan												
			CLAY, Sandy, Firm to Hard, Tan and Gray												
			-DRILLER'S NOTE: WATER encountered at 14 ft	7										32	
				50/11"										51	
				50/10"											
				38										18	
			SAND, Clayey, Very Dense, Gray	50/8"											
				50/10"										29	

NOTE: THESE LOGS SHOULD NOT BE USED SEPARATELY FROM THE PROJECT REPORT

DEPTH DRILLED: 39.8 ft	DEPTH TO WATER: 14 ft	PROJ. No.: ASA12-098-00
DATE DRILLED: 10/18/2012	DATE MEASURED: 10/18/2012	FIGURE: A-7

LOG OF BORING NO. B-7

Ash Pond Berms - Spruce/Deely Generation Units
San Antonio, Texas



DRILLING METHOD: Straight Flight Auger

LOCATION: N 29.30899; W 98.31660

DEPTH, FT	SYMBOL	SAMPLES	DESCRIPTION OF MATERIAL	BLOWS PER FT	UNIT DRY WEIGHT, pcf	SHEAR STRENGTH, TONS/FT ²			PLASTICITY INDEX	% -200
						0.5	1.0	1.5		
SURFACE ELEVATION: 500 ft										
			FILL MATERIAL: SAND, Clayey, Medium Dense, Brown	10						
			FILL MATERIAL: CLAY, Sandy, Very Stiff, Tan and Gray	29						
5				22					19	
				115						
10									17	
-DRILLER'S NOTE: WATER encountered at 11 ft										
			SAND, Clayey, Very Dense, Tan and Gray	50/9"						47
15										
				50/11"						
20			CLAY, Sandy, Hard, Tan and Gray							
				50/9"					18	
25										
				47						
30										
35										

NOTE: THESE LOGS SHOULD NOT BE USED SEPARATELY FROM THE PROJECT REPORT

DEPTH DRILLED: 30.0 ft	DEPTH TO WATER: 11 ft	PROJ. No.: ASA12-098-00
DATE DRILLED: 10/16/2012	DATE MEASURED: 10/16/2012	FIGURE: A-8

LOG OF BORING NO. B-8

Ash Pond Berms - Spruce/Deely Generation Units
San Antonio, Texas



DRILLING METHOD: Straight Flight Auger

LOCATION: N 29.30884; W 98.31510

DEPTH, FT	SYMBOL	SAMPLES	DESCRIPTION OF MATERIAL	BLOWS PER FT	UNIT DRY WEIGHT, pcf	SHEAR STRENGTH, TONS/FT ²			PLASTICITY INDEX	% -200
						0.5	1.0	1.5		
SURFACE ELEVATION: 501 ft										
5			FILL MATERIAL: SAND, Clayey, Loose to Medium Dense, Brown and Tan	25						
7			-with a tan and gray clay seam from 6 to 8 ft	14						NP
11				7						39
11				113						
15			CLAY, Sandy, Very Stiff, Tan and Gray							
15				111						
20			SAND, Clayey, Medium Dense to Dense, Tan and Gray -DRILLER'S NOTE: WATER encountered at 16 ft							
20				25						47
25				10						18
30				25						
35			-with a tan and gray clay seam from 33 to 35 ft	38						52
50/8"										9
DEPTH DRILLED: 39.7 ft			DEPTH TO WATER: 16 ft			PROJ. No.: ASA12-098-00				
DATE DRILLED: 10/19/2012			DATE MEASURED: 10/19/2012			FIGURE: A-9				

NOTE: THESE LOGS SHOULD NOT BE USED SEPARATELY FROM THE PROJECT REPORT

LOG OF BORING NO. B-9

Ash Pond Berms - Spruce/Deely Generation Units
San Antonio, Texas



DRILLING METHOD: Straight Flight Auger

LOCATION: N 29.30802; W 98.31601

DEPTH, FT	SYMBOL	SAMPLES	DESCRIPTION OF MATERIAL	BLOWS PER FT	UNIT DRY WEIGHT, pcf	SHEAR STRENGTH, TONS/FT ²			PLASTICITY INDEX	% -200
						0.5	1.0	1.5		
SURFACE ELEVATION: 499 ft										
			FILL MATERIAL: SAND, Medium Dense, Brown and Tan	11						
			FILL MATERIAL: CLAY, Stiff to Very Stiff, Tan	14						
5				16					21	
				11						
10			SAND, Clayey, Loose to Very Dense, Tan and Gray							
				9						49
			-DRILLER'S NOTE: WATER encountered at 16 ft							
				50/11"						
				ref/1"						
			CLAY, Sandy, Hard, Tan and Gray	50/11"						62
30										
35										

NOTE: THESE LOGS SHOULD NOT BE USED SEPARATELY FROM THE PROJECT REPORT

DEPTH DRILLED: 29.9 ft DATE DRILLED: 10/17/2012	DEPTH TO WATER: 16 ft DATE MEASURED: 10/17/2012	PROJ. No.: ASA12-098-00 FIGURE: A-10
--	--	---

LOG OF BORING NO. B-10

Ash Pond Berms - Spruce/Deely Generation Units
San Antonio, Texas



DRILLING METHOD: Straight Flight Auger

LOCATION: N 29.30769; W 98.31855

DEPTH, FT	SYMBOL	SAMPLES	DESCRIPTION OF MATERIAL	BLOWS PER FT	UNIT DRY WEIGHT, pcf	SHEAR STRENGTH, TONS/FT ²				PLASTICITY INDEX	% -200	
						0.5	1.0	1.5	2.0			2.5
SURFACE ELEVATION: 496 ft												
5			FILL MATERIAL: CLAY, Sandy, Very Stiff, Tan	16								
				16								16
				19								
				24								
10				19								27
			SAND, Clayey, Medum Dense to Very Dense, Tan and Gray, with intermittent clay seams									
15					97							41
			-DRILLER'S NOTE: WATER encountered at 17 ft									
20				38								
25				17								
30				ref/1"								
35				50/9"								42
			CLAY, Very Stiff, Dark Gray									
				26								

NOTE: THESE LOGS SHOULD NOT BE USED SEPARATELY FROM THE PROJECT REPORT

DEPTH DRILLED: 40.0 ft DATE DRILLED: 10/17/2012	DEPTH TO WATER: 17 ft DATE MEASURED: 10/17/2012	PROJ. No.: ASA12-098-00 FIGURE: A-11
--	--	---

LOG OF BORING NO. B-11

Ash Pond Berms - Spruce/Deely Generation Units
San Antonio, Texas



DRILLING METHOD: Straight Flight Auger

LOCATION: N 29.30737; W 98.31744

DEPTH, FT	SYMBOL	SAMPLES	DESCRIPTION OF MATERIAL	BLOWS PER FT	UNIT DRY WEIGHT, pcf	SHEAR STRENGTH, TONS/FT ²				PLASTICITY INDEX	% -200	
						0.5	1.0	1.5	2.0			2.5
			SURFACE ELEVATION: 496 ft									
5			FILL MATERIAL: CLAY, Sandy, Stiff to Very Stiff, Tan to Brown -with a tan sand seam from 4 to 6 ft	15							16	
12				12								49
18				18								
10												
15			SAND, Clayey, Medium Dense to Dense, Tan and Gray, with intermittent clay seams -DRILLER'S NOTE: WATER encountered at 16 ft	18								
20				18								
25				49								34
30				42								
35												

NOTE: THESE LOGS SHOULD NOT BE USED SEPARATELY FROM THE PROJECT REPORT

DEPTH DRILLED: 30.0 ft	DEPTH TO WATER: 16 ft	PROJ. No.: ASA12-098-00
DATE DRILLED: 10/18/2012	DATE MEASURED: 10/18/2012	FIGURE: A-12

LOG OF BORING NO. B-12

Ash Pond Berms - Spruce/Deely Generation Units
San Antonio, Texas



DRILLING METHOD: Straight Flight Auger

LOCATION: N 29.30757; W 98.31509

DEPTH, FT	SYMBOL	SAMPLES	DESCRIPTION OF MATERIAL	BLOWS PER FT	UNIT DRY WEIGHT, pcf	SHEAR STRENGTH, TONS/FT ²		PLASTICITY INDEX	% -200						
						0.5 1.0 1.5 2.0 2.5 3.0 3.5 4.0	PLASTIC LIMIT WATER CONTENT LIQUID LIMIT								
			SURFACE ELEVATION: 500 ft			10	20	30	40	50	60	70	80		
23	[Wavy Pattern]	X	FILL MATERIAL: SAND, Clayey, Loose to Medium Dense, Brown, with gravel	6											46
5	[Diagonal Hatching]	X	CLAY, Sandy, Firm to Hard, Tan to Brown	8											18
27	[Diagonal Hatching]	X		27											21
10	[Diagonal Hatching]	X		18											
15	[Diagonal Hatching]	X	-DRILLER'S NOTE: WATER encountered at 16 ft	24											
25	[Diagonal Hatching]	X		50/11"											51
25	[Dotted Pattern]	X	SANDSTONE, Hard, Gray												
30	[Diagonal Hatching]	X	SAND, Clayey, Medium Dense, Tan and Gray	11											
35	[Diagonal Hatching]	X													

NOTE: THESE LOGS SHOULD NOT BE USED SEPARATELY FROM THE PROJECT REPORT

DEPTH DRILLED: 30.0 ft	DEPTH TO WATER: 16 ft	PROJ. No.: ASA12-098-00
DATE DRILLED: 10/17/2012	DATE MEASURED: 10/17/2012	FIGURE: A-13

LOG OF BORING NO. B-13

Ash Pond Berms - Spruce/Deely Generation Units
San Antonio, Texas



DRILLING METHOD: Straight Flight Auger

LOCATION: N 29.30715; W 98.31792

DEPTH, FT	SYMBOL	SAMPLES	DESCRIPTION OF MATERIAL	BLOWS PER FT	UNIT DRY WEIGHT, pcf	SHEAR STRENGTH, TONS/FT ²				PLASTICITY INDEX	% -200	
						0.5	1.0	1.5	2.0			2.5
SURFACE ELEVATION: 496 ft												
5			FILL MATERIAL: CLAY, Sandy, Very Stiff to Hard, Tan to Brown -with a tan sand seam from 4 to 6 ft	23								
				27							16	
				34								43
				16								
10												
15			CLAY, Sandy, Very Stiff to Hard, Tan and Gray -DRILLER'S NOTE: WATER encountered at 16 ft	18								
20				19								53
25				41								
30				34							33	
35				41								
				39								

NOTE: THESE LOGS SHOULD NOT BE USED SEPARATELY FROM THE PROJECT REPORT

DEPTH DRILLED: 40.0 ft	DEPTH TO WATER: 16 ft	PROJ. No.: ASA12-098-00
DATE DRILLED: 10/18/2012	DATE MEASURED: 10/18/2012	FIGURE: A-14

LOG OF BORING NO. B-14

Ash Pond Berms - Spruce/Deely Generation Units
San Antonio, Texas



DRILLING METHOD: Straight Flight Auger

LOCATION: N 29.30684; W 98.31590

DEPTH, FT	SYMBOL	SAMPLES	DESCRIPTION OF MATERIAL	BLOWS PER FT	UNIT DRY WEIGHT, pcf	SHEAR STRENGTH, TONS/FT ²				PLASTICITY INDEX	% -200
						0.5	1.0	1.5	2.0		
SURFACE ELEVATION: 501 ft											
9			FILL MATERIAL: SAND, Clayey, Loose to Dense, Brown and Tan	9							
30				30							46
5			CLAY, Sandy, Very Stiff to Hard, Tan to Tan and Gray	18						27	
118				118							
117				117							
15			-DRILLER'S NOTE: WATER encountered at 16 ft								
20				15						36	
25				ref/3"							
30				32							72
35			SAND, Clayey, Very Dense, Tan and Gray	50/9"							
				50/8"							
DEPTH DRILLED:			39.7 ft	DEPTH TO WATER:			16 ft	PROJ. No.:		ASA12-098-00	
DATE DRILLED:			10/19/2012	DATE MEASURED:			10/19/2012	FIGURE:		A-15	

NOTE: THESE LOGS SHOULD NOT BE USED SEPARATELY FROM THE PROJECT REPORT

KEY TO TERMS AND SYMBOLS

MATERIAL TYPES

SOIL TERMS

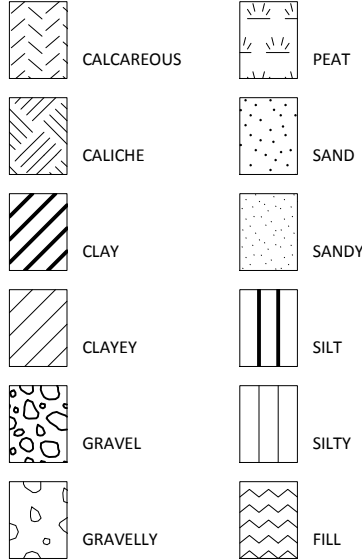

ROCK TERMS

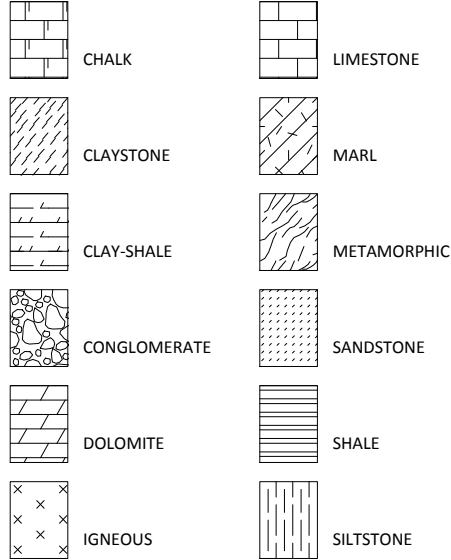

OTHER

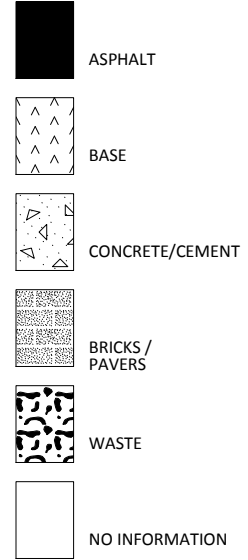

WELL CONSTRUCTION AND PLUGGING MATERIALS

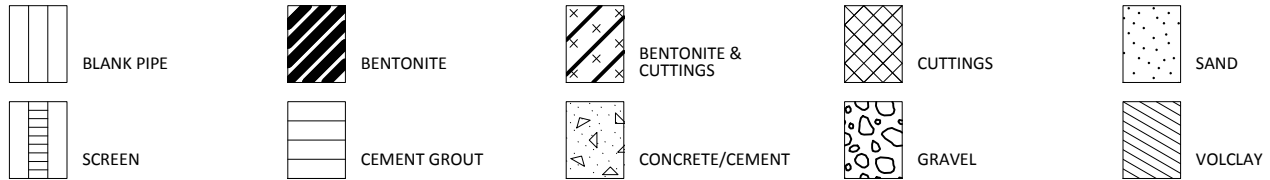

SAMPLE TYPES

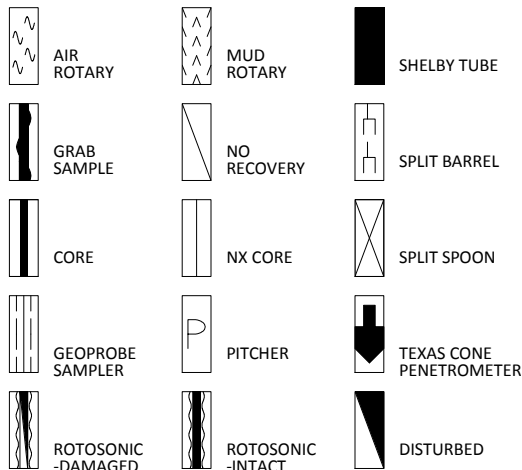

STRENGTH TEST TYPES

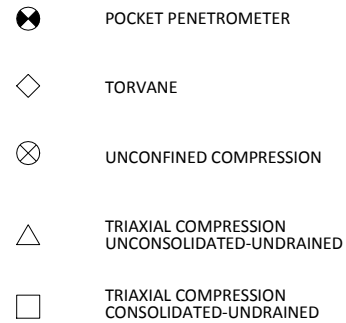

NOTE: VALUES SYMBOLIZED ON BORING LOGS REPRESENT SHEAR STRENGTHS UNLESS OTHERWISE NOTED

PROJECT NO. ASA12-098-00

KEY TO TERMS AND SYMBOLS (CONT'D)

TERMINOLOGY

Terms used in this report to describe soils with regard to their consistency or conditions are in general accordance with the discussion presented in Article 45 of SOILS MECHANICS IN ENGINEERING PRACTICE, Terzaghi and Peck, John Wiley & Sons, Inc., 1967, using the most reliable information available from the field and laboratory investigations. Terms used for describing soils according to their texture or grain size distribution are in accordance with the UNIFIED SOIL CLASSIFICATION SYSTEM, as described in American Society for Testing and Materials D2487-06 and D2488-00, Volume 04.08, Soil and Rock; Dimension Stone; Geosynthetics; 2005.

The depths shown on the boring logs are not exact, and have been estimated to the nearest half-foot. Depth measurements may be presented in a manner that implies greater precision in depth measurement, i.e 6.71 meters. The reader should understand and interpret this information only within the stated half-foot tolerance on depth measurements.

RELATIVE DENSITY

COHESIVE STRENGTH

PLASTICITY

<u>Penetration Resistance Blows per ft</u>	<u>Relative Density</u>	<u>Resistance Blows per ft</u>	<u>Consistency</u>	<u>Cohesion TSF</u>	<u>Plasticity Index</u>	<u>Degree of Plasticity</u>
0 - 4	Very Loose	0 - 2	Very Soft	0 - 0.125	0 - 5	None
4 - 10	Loose	2 - 4	Soft	0.125 - 0.25	5 - 10	Low
10 - 30	Medium Dense	4 - 8	Firm	0.25 - 0.5	10 - 20	Moderate
30 - 50	Dense	8 - 15	Stiff	0.5 - 1.0	20 - 40	Plastic
> 50	Very Dense	15 - 30	Very Stiff	1.0 - 2.0	> 40	Highly Plastic
		> 30	Hard	> 2.0		

ABBREVIATIONS

B = Benzene	Qam, Qas, Qal = Quaternary Alluvium	Kef = Eagle Ford Shale
T = Toluene	Qat = Low Terrace Deposits	Kbu = Buda Limestone
E = Ethylbenzene	Qbc = Beaumont Formation	Kdr = Del Rio Clay
X = Total Xylenes	Qt = Fluvial Terrace Deposits	Kft = Fort Terrett Member
BTEX = Total BTEX	Qao = Seymour Formation	Kgt = Georgetown Formation
TPH = Total Petroleum Hydrocarbons	Qle = Leona Formation	Kep = Person Formation
ND = Not Detected	Q-Tu = Uvalde Gravel	Kek = Kainer Formation
NA = Not Analyzed	Ewi = Wilcox Formation	Kes = Escondido Formation
NR = Not Recorded/No Recovery	Emi = Midway Group	Kew = Walnut Formation
OVA = Organic Vapor Analyzer	Mc = Catahoula Formation	Kgr = Glen Rose Formation
ppm = Parts Per Million	EI = Laredo Formation	Kgru = Upper Glen Rose Formation
	Kknm = Navarro Group and Marlbrook Marl	Kgrl = Lower Glen Rose Formation
	Kpg = Pecan Gap Chalk	Kh = Hensell Sand
	Kau = Austin Chalk	

PROJECT NO. ASA12-098-00

KEY TO TERMS AND SYMBOLS (CONT'D)

TERMINOLOGY

SOIL STRUCTURE

Slickensided	Having planes of weakness that appear slick and glossy.
Fissured	Containing shrinkage or relief cracks, often filled with fine sand or silt; usually more or less vertical.
Pocket	Inclusion of material of different texture that is smaller than the diameter of the sample.
Parting	Inclusion less than 1/8 inch thick extending through the sample.
Seam	Inclusion 1/8 inch to 3 inches thick extending through the sample.
Layer	Inclusion greater than 3 inches thick extending through the sample.
Laminated	Soil sample composed of alternating partings or seams of different soil type.
Interlayered	Soil sample composed of alternating layers of different soil type.
Intermixed	Soil sample composed of pockets of different soil type and layered or laminated structure is not evident.
Calcareous	Having appreciable quantities of carbonate.
Carbonate	Having more than 50% carbonate content.

SAMPLING METHODS

RELATIVELY UNDISTURBED SAMPLING

Cohesive soil samples are to be collected using three-inch thin-walled tubes in general accordance with the Standard Practice for Thin-Walled Tube Sampling of Soils (ASTM D1587) and granular soil samples are to be collected using two-inch split-barrel samplers in general accordance with the Standard Method for Penetration Test and Split-Barrel Sampling of Soils (ASTM D1586). Cohesive soil samples may be extruded on-site when appropriate handling and storage techniques maintain sample integrity and moisture content.

STANDARD PENETRATION TEST (SPT)

A 2-in.-OD, 1-3/8-in.-ID split spoon sampler is driven 1.5 ft into undisturbed soil with a 140-pound hammer free falling 30 in. After the sampler is seated 6 in. into undisturbed soil, the number of blows required to drive the sampler the last 12 in. is the Standard Penetration Resistance or "N" value, which is recorded as blows per foot as described below.

SPLIT-BARREL SAMPLER DRIVING RECORD

<u>Blows Per Foot</u>	<u>Description</u>
25	25 blows drove sampler 12 inches, after initial 6 inches of seating.
50/7"	50 blows drove sampler 7 inches, after initial 6 inches of seating.
Ref/3"	50 blows drove sampler 3 inches during initial 6-inch seating interval.

NOTE: To avoid damage to sampling tools, driving is limited to 50 blows during or after seating interval.

APPENDIX B

LABORATORY TEST RESULTS

RESULTS OF SOIL SAMPLE ANALYSES

PROJECT NAME: Ash Pond Berms - Spruce/Deely Generation Units
San Antonio, Texas

FILE NAME: ASA12-098-00.GPJ

11/20/2012

Boring No.	Sample Depth (ft)	Blows per ft	Water Content (%)	Liquid Limit	Plastic Limit	Plasticity Index	USCS	Dry Unit Weight (pcf)	% -200 Sieve	Shear Strength (tsf)	Strength Test
B-1	0.0 to 1.5	11	15								
	2.5 to 4.0	7	23								
	4.0 to 6.0		18	31	15	16	CL	106	50	0.27	UC
	6.0 to 8.0		15					110		1.09	UC
	8.0 to 10.0		13					112	40	0.39	UC
	13.5 to 15.0	16	21	55	18	37	CH				
	18.5 to 20.0	22	18								
	23.5 to 24.9	50/11"	14								
	28.5 to 29.9	50/11"	11						43		
	33.5 to 35.0	49	20								
	38.5 to 39.9	50/11"	20								
	43.5 to 44.8	50/9"	19								
	48.5 to 49.7	50/8"	19								
B-2	0.0 to 1.5	11	18								
	2.0 to 4.0		11					119	38	2.59	UC
	4.0 to 6.0		17	33	18	15	CL	104		0.79	UC
	6.0 to 8.0		19					102		0.28	UC
	8.0 to 10.0		17					110		0.98	UC
	13.0 to 15.0		18	54	18	36	CH			2.00	PP
	18.0 to 20.0		13					101		0.65	UC
	23.5 to 24.9	50/11"	12						24		
	28.5 to 29.8	50/10"	20								
	33.5 to 35.0	38	12								
	38.5 to 40.0	50	20								
	43.5 to 44.7	50/8"	18								
	48.5 to 49.8	50/9"	20								
B-3	0.0 to 1.5	24	13								
	2.5 to 4.0	12	15								
	4.5 to 6.0	11	17	34	15	19	CL				
	6.5 to 8.0	19	17						41		
	8.5 to 10.0	14	17								
	13.0 to 15.0		18	42	12	30	CL	112		0.73	UC
	18.0 to 20.0		15							2.00	PP
	23.5 to 25.0	46	11						47		
	28.5 to 30.0	50									
	33.5 to 34.9	50/11"	13								
	38.5 to 39.9	50/11"	18						33		
	43.5 to 45.0	38	27								
	48.5 to 49.8	50/10"	22								

PP = Pocket Penetrometer TV = Torvane UC = Unconfined Compression FV = Field Vane UU = Unconsolidated Undrained Triaxial
CU = Consolidated Undrained Triaxial

PROJECT NO. ASA12-098-00

RABAKISTNER

FIGURE B-1a

RESULTS OF SOIL SAMPLE ANALYSES

PROJECT NAME: Ash Pond Berms - Spruce/Deely Generation Units
San Antonio, Texas

FILE NAME: ASA12-098-00.GPJ

11/20/2012

Boring No.	Sample Depth (ft)	Blows per ft	Water Content (%)	Liquid Limit	Plastic Limit	Plasticity Index	USCS	Dry Unit Weight (pcf)	% -200 Sieve	Shear Strength (tsf)	Strength Test
B-4	0.0 to 1.5	7	16	40	15	25	CL				
	2.5 to 4.0	5	14						54		
	4.5 to 6.0	14	12	45	15	30	CL				
	6.0 to 8.0		14					113		1.96	UC
	8.0 to 10.0		11					110		0.71	UC
	13.5 to 15.0	26	18	41	14	27	CL				
	18.5 to 20.0	49	10								
	23.5 to 25.0	24	15								
	28.0 to 30.0		13					97	32	1.50	PP
	33.5 to 35.0	50	14								
	38.5 to 39.8	50/10"	25								
	43.5 to 45.0	50	24								
B-5	48.5 to 49.8	50/9"	19						23		
	0.0 to 1.5	17	13								
	2.5 to 4.0	21	14								
	4.5 to 6.0	24	13								
	6.5 to 8.0	20	16	32	13	19	CL				
	8.0 to 10.0		14						46	2.00	PP
	13.5 to 15.0	33	26						46		
	18.5 to 19.8	50/10"	24								
	23.5 to 24.8	50/9"	22								
	28.5 to 30.0	24	21								
B-6	33.5 to 34.6	50/7"	24						31		
	38.5 to 39.7	50/8"									
	0.0 to 1.5	15	11								
	2.5 to 4.0	14	16	33	18	15	CL				
	4.5 to 6.0	24	13						50		
	6.5 to 8.0	19	15								
	8.5 to 10.0	21	17								
	13.5 to 15.0	7	24	49	17	32	CL				
	18.5 to 19.9	50/11"	25						51		
	23.5 to 24.8	50/10"	23								
B-7	28.5 to 30.0	38	21	38	20	18	CL				
	33.5 to 34.7	50/8"	23								
	38.5 to 39.8	50/10"	26						29		
	0.0 to 1.5	10	19								
	2.5 to 4.0	29	7								
	4.5 to 6.0	22	14	34	15	19	CL				
	6.0 to 8.0		16					115		1.37	UC

PP = Pocket Penetrometer TV = Torvane UC = Unconfined Compression FV = Field Vane UU = Unconsolidated Undrained Triaxial
CU = Consolidated Undrained Triaxial

PROJECT NO. ASA12-098-00

RABAKISTNER

FIGURE B-1b

RESULTS OF SOIL SAMPLE ANALYSES

PROJECT NAME: Ash Pond Berms - Spruce/Deely Generation Units
San Antonio, Texas

FILE NAME: ASA12-098-00.GPJ

11/20/2012

Boring No.	Sample Depth (ft)	Blows per ft	Water Content (%)	Liquid Limit	Plastic Limit	Plasticity Index	USCS	Dry Unit Weight (pcf)	% -200 Sieve	Shear Strength (tsf)	Strength Test
B-7	8.0 to 10.0		14	32	15	17	CL			2.00	PP
	13.5 to 14.8	50/9"	25						47		
	18.5 to 19.9	50/11"	23								
	23.5 to 24.8	50/9"	19	35	17	18	CL				
	28.5 to 30.0	47	19								
B-8	0.0 to 1.5	25	16								
	2.5 to 4.0	14	39			NP					
	4.5 to 6.0	7	16						39		
	6.0 to 8.0		15					113		0.78	UC
	8.0 to 10.0									2.00	PP
	13.0 to 15.0		18					111		0.39	UC
	18.5 to 20.0	25	23						47		
	23.5 to 25.0	10	20	33	15	18	CL				
	28.5 to 30.0	25	22								
	33.5 to 35.0	38	19						52		
B-9	38.5 to 39.7	50/8"	24	29	20	9	CL				
	0.0 to 1.5	11	13								
	2.5 to 4.0	14	16								
	4.5 to 6.0	16	15	35	14	21	CL				
	6.5 to 8.0	11	20								
	8.0 to 10.0		21							1.50	PP
	13.5 to 15.0	9	23						49		
	18.5 to 19.9	50/11"	24								
B-10	23.5 to 23.6	ref/1"	26								
	28.5 to 29.9	50/11"	20						62		
	0.0 to 1.5	16	13								
	2.5 to 4.0	16	16	32	16	16	CL				
	4.5 to 6.0	19	14								
	6.5 to 8.0	24	18								
	8.5 to 10.0	19	15	42	15	27	CL				
	13.0 to 15.0		22					97	41	0.23	UC
	18.5 to 20.0	38	26								
	23.5 to 25.0	17	29								
B-11	28.5 to 28.6	ref/1"	6								
	33.5 to 34.8	50/9"	19						42		
	38.5 to 40.0	26	21								
	0.0 to 1.5	15	14	32	16	16	CL				
	2.5 to 4.0	11	15								
	4.5 to 6.0	12	17					49			

PP = Pocket Penetrometer TV = Torvane UC = Unconfined Compression FV = Field Vane UU = Unconsolidated Undrained Triaxial
CU = Consolidated Undrained Triaxial

PROJECT NO. ASA12-098-00

RABAKISTNER

FIGURE B-1c

RESULTS OF SOIL SAMPLE ANALYSES

PROJECT NAME: Ash Pond Berms - Spruce/Deely Generation Units
San Antonio, Texas

FILE NAME: ASA12-098-00.GPJ

11/20/2012

Boring No.	Sample Depth (ft)	Blows per ft	Water Content (%)	Liquid Limit	Plastic Limit	Plasticity Index	USCS	Dry Unit Weight (pcf)	% -200 Sieve	Shear Strength (tsf)	Strength Test
B-11	6.5 to 8.0	18	13								
	8.0 to 10.0									2.00	PP
	13.5 to 15.0	18	18								
	18.5 to 20.0	18	26								
	23.5 to 25.0	49	23						34		
B-12	28.5 to 30.0	42	24								
	0.0 to 1.5	23	28						46		
	2.5 to 4.0	6	38								
	4.5 to 6.0	8	16	32	14	18	CL				
	6.5 to 8.0	27	14								
	8.0 to 10.0		15	34	13	21	CL			2.00	PP
	13.5 to 15.0	18	18								
B-13	18.5 to 20.0	24	28								
	23.5 to 24.9	50/11"	23						51		
	28.5 to 30.0	11	28								
	0.0 to 1.5	23	13								
	2.5 to 4.0	27	14	33	17	16	CL				
	4.5 to 6.0	34	14						43		
	6.5 to 8.0	16	15								
	8.0 to 10.0									2.00	PP
	13.5 to 15.0	18	19								
	18.5 to 20.0	19	24						53		
B-14	23.5 to 25.0	41	25								
	28.5 to 30.0	34	26	52	19	33	CH				
	33.5 to 35.0	41	21								
	38.5 to 40.0	39	20								
	0.0 to 1.5	9	9								
	2.5 to 4.0	30	8						46		
	4.5 to 6.0	18	13	41	14	27	CL				
	6.0 to 8.0		14					118		1.10	UC
	8.0 to 10.0		15					117		1.15	UC
	13.0 to 15.0									1.25	PP
B-14	18.5 to 20.0	15	19	51	15	36	CH				
	23.5 to 23.8	ref/3"	5								
	28.5 to 30.0	32	25						72		
	33.5 to 34.8	50/9"	19								
	38.5 to 39.7	50/8"	18								

PP = Pocket Penetrometer TV = Torvane UC = Unconfined Compression FV = Field Vane UU = Unconsolidated Undrained Triaxial
CU = Consolidated Undrained Triaxial

PROJECT NO. ASA12-098-00

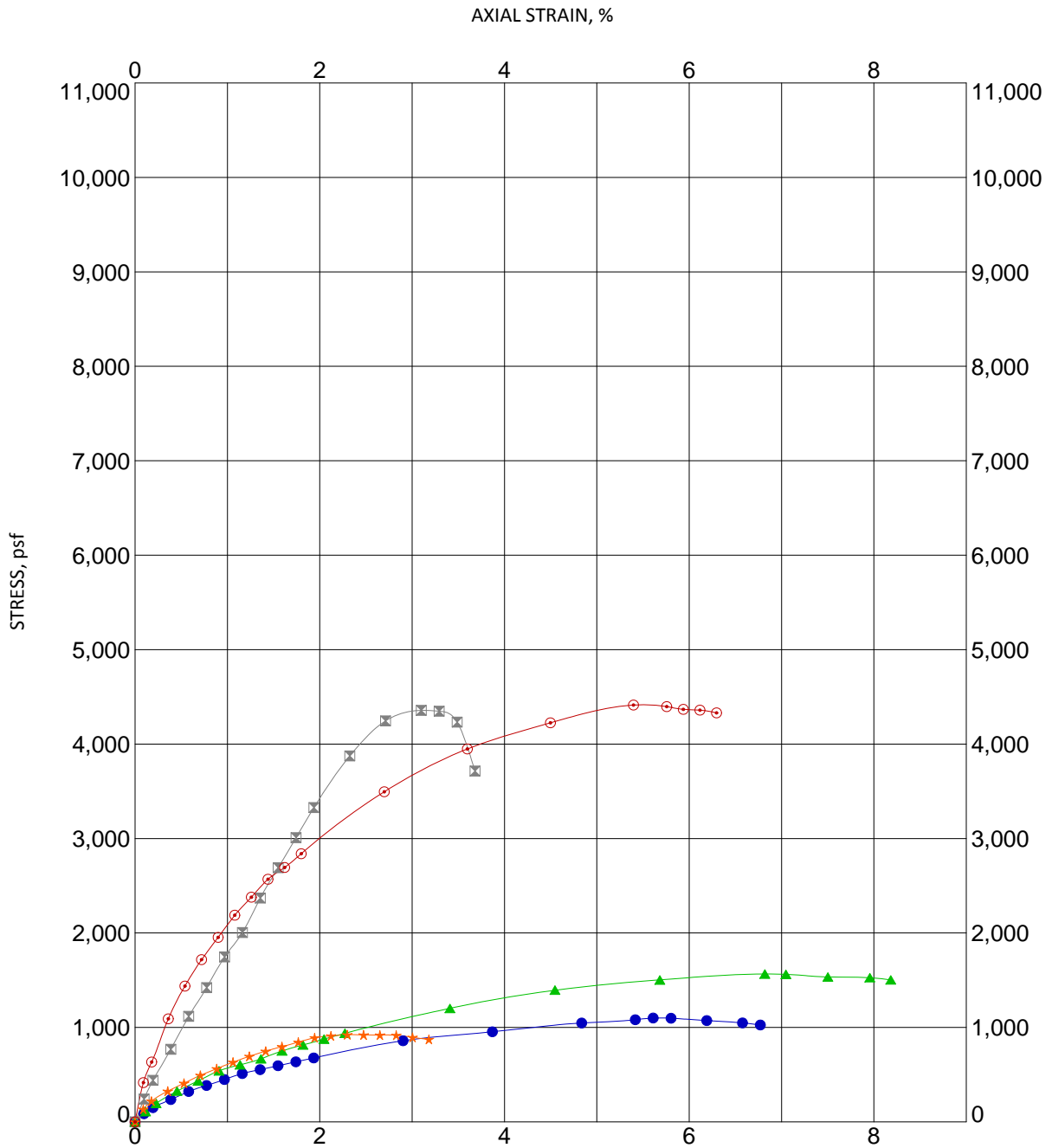

FIGURE B-2

Specimen Identification	Classification	Shear Str. (tsf)	Failure Strain (%)	PI	Dry Unit Weight (pcf)	w (%)
● B-1 4 ft		0.3	5.6	16	106.0	17.7
⊠ B-1 6 ft		1.1	3.1		109.9	15.4
▲ B-1 8 ft		0.4	6.8		111.8	13.2
★ B-10 13 ft		0.2	2.3		97.4	24.5
⊙ B-14 6 ft		1.1	5.4		117.9	13.6

R-K UNCONFINED COMPRESSION ASA12-098-00.GPJ RKCI.GDT 11/20/12



12821 W. Golden Lane
 San Antonio, Texas 78249
 (210) 699-9090
 (210) 699-6426 fax
 www.rkci.com

UNCONFINED COMPRESSION

Ash Pond Berms - Spruce/Deely Generation Units
 San Antonio, Texas

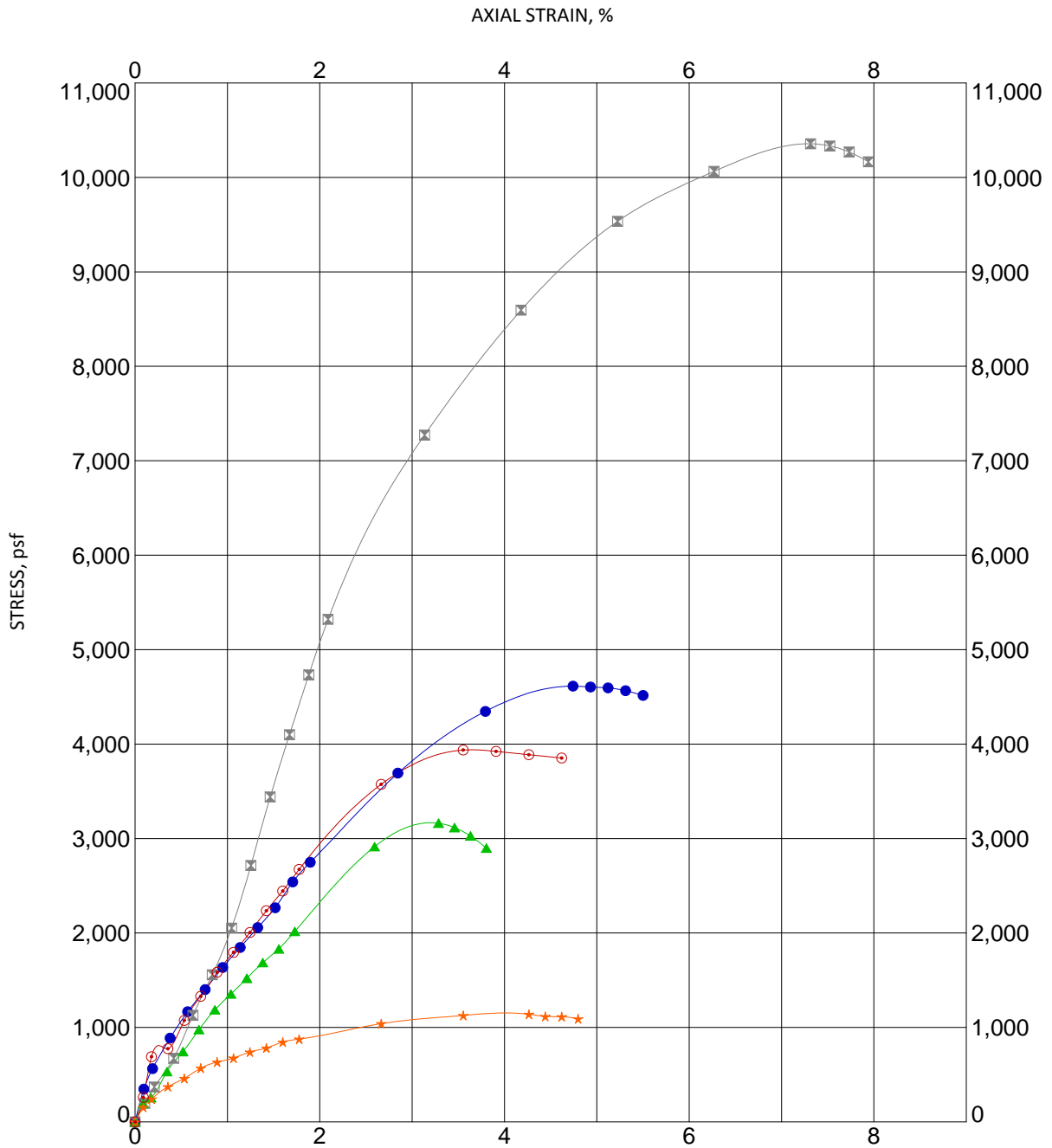

FIGURE B-3

Specimen Identification	Classification	Shear Str. (tsf)	Failure Strain (%)	PI	Dry Unit Weight (pcf)	w (%)
● B-14 8 ft		1.2	4.7		116.9	14.7
⊠ B-2 2 ft		2.6	7.3		119.3	10.9
▲ B-2 4 ft		0.8	3.3	15	104.0	16.6
★ B-2 6 ft		0.3	4.3		102.1	19.0
⊙ B-2 8 ft		1.0	3.6		110.3	16.9

R-K UNCONFINED COMPRESSION ASA12-098-00.GPJ RKCI.GDT 11/20/12



12821 W. Golden Lane
 San Antonio, Texas 78249
 (210) 699-9090
 (210) 699-6426 fax
 www.rkci.com

UNCONFINED COMPRESSION

Ash Pond Berms - Spruce/Deely Generation Units
 San Antonio, Texas

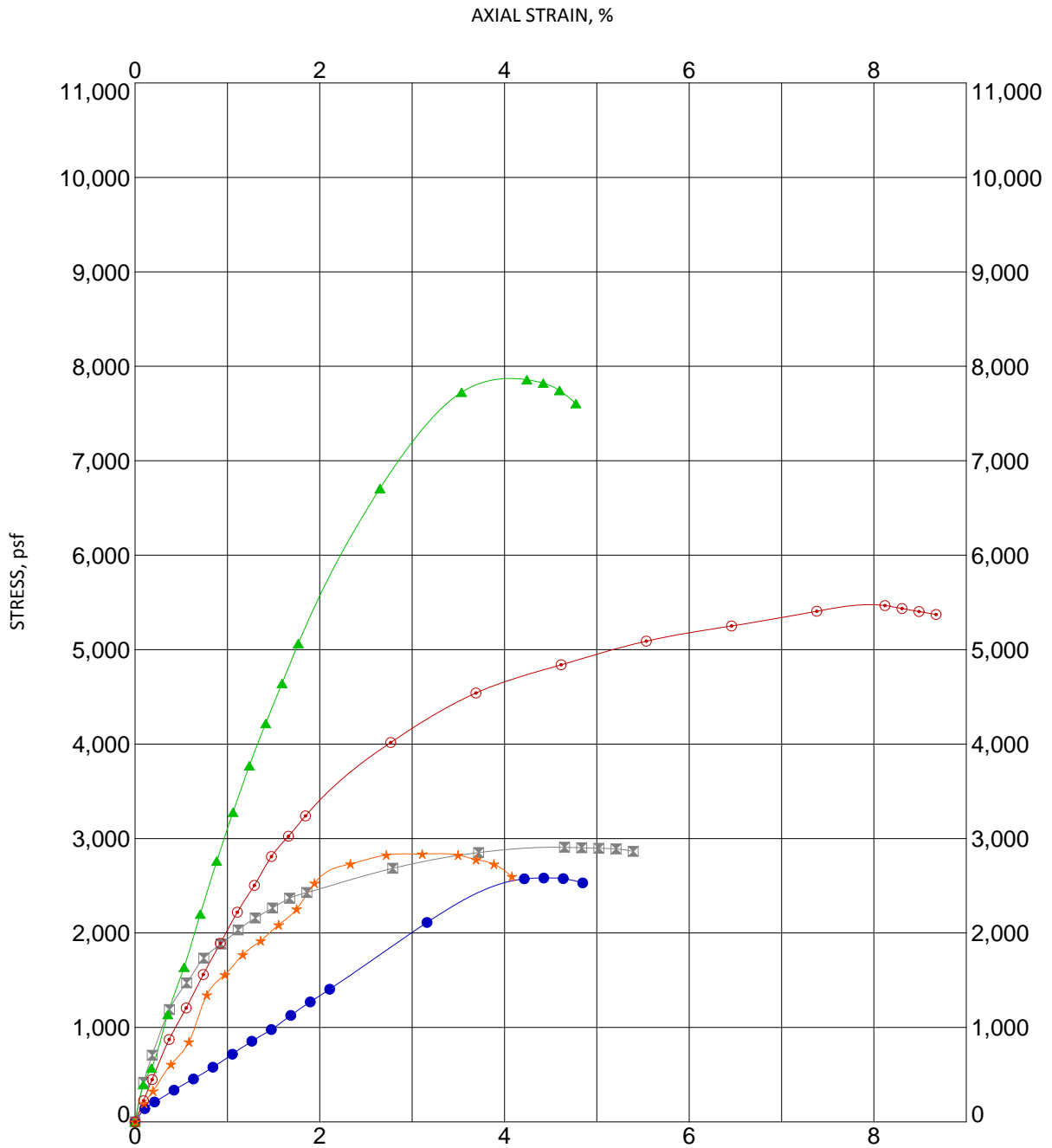

FIGURE B-4

Specimen Identification	Classification	Shear Str. (tsf)	Failure Strain (%)	PI	Dry Unit Weight (pcf)	w (%)
● B-2 18 ft		0.6	4.4		100.8	13.0
☒ B-3 13 ft		0.7	4.7	30	112.2	17.6
▲ B-4 6 ft		2.0	4.2		113.1	14.3
★ B-4 8 ft		0.7	3.1		109.8	10.6
○ B-7 6 ft		1.4	8.1		115.1	15.7

R-K UNCONFINED COMPRESSION ASA12-098-00.GPJ RKCI.GDT 11/20/12



12821 W. Golden Lane
 San Antonio, Texas 78249
 (210) 699-9090
 (210) 699-6426 fax
 www.rkci.com

UNCONFINED COMPRESSION

Ash Pond Berms - Spruce/Deely Generation Units
 San Antonio, Texas

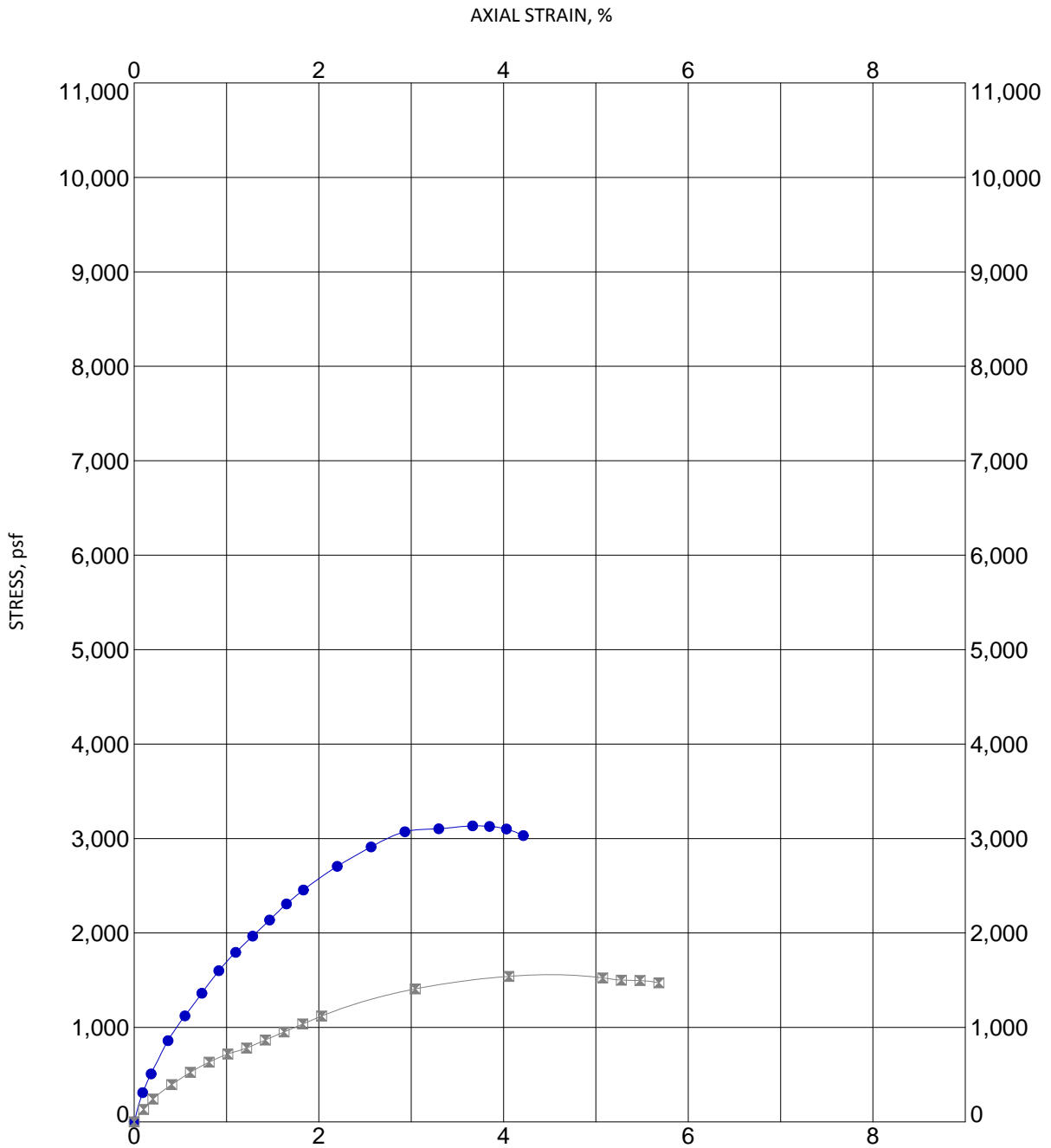

FIGURE B-5

Specimen Identification	Classification	Shear Str. (tsf)	Failure Strain (%)	PI	Dry Unit Weight (pcf)	w (%)
● B-8 6 ft		0.8	3.7		112.6	15.1
⊠ B-8 13 ft		0.4	4.1		110.8	18.1

R-K UNCONFINED COMPRESSION ASA12-098-00.GPJ RKCI.GDT 11/20/12



12821 W. Golden Lane
 San Antonio, Texas 78249
 (210) 699-9090
 (210) 699-6426 fax
 www.rkci.com

UNCONFINED COMPRESSION

Ash Pond Berms - Spruce/Deely Generation Units
 San Antonio, Texas

APPENDIX C

SLOPE STABILITY ANALYSES

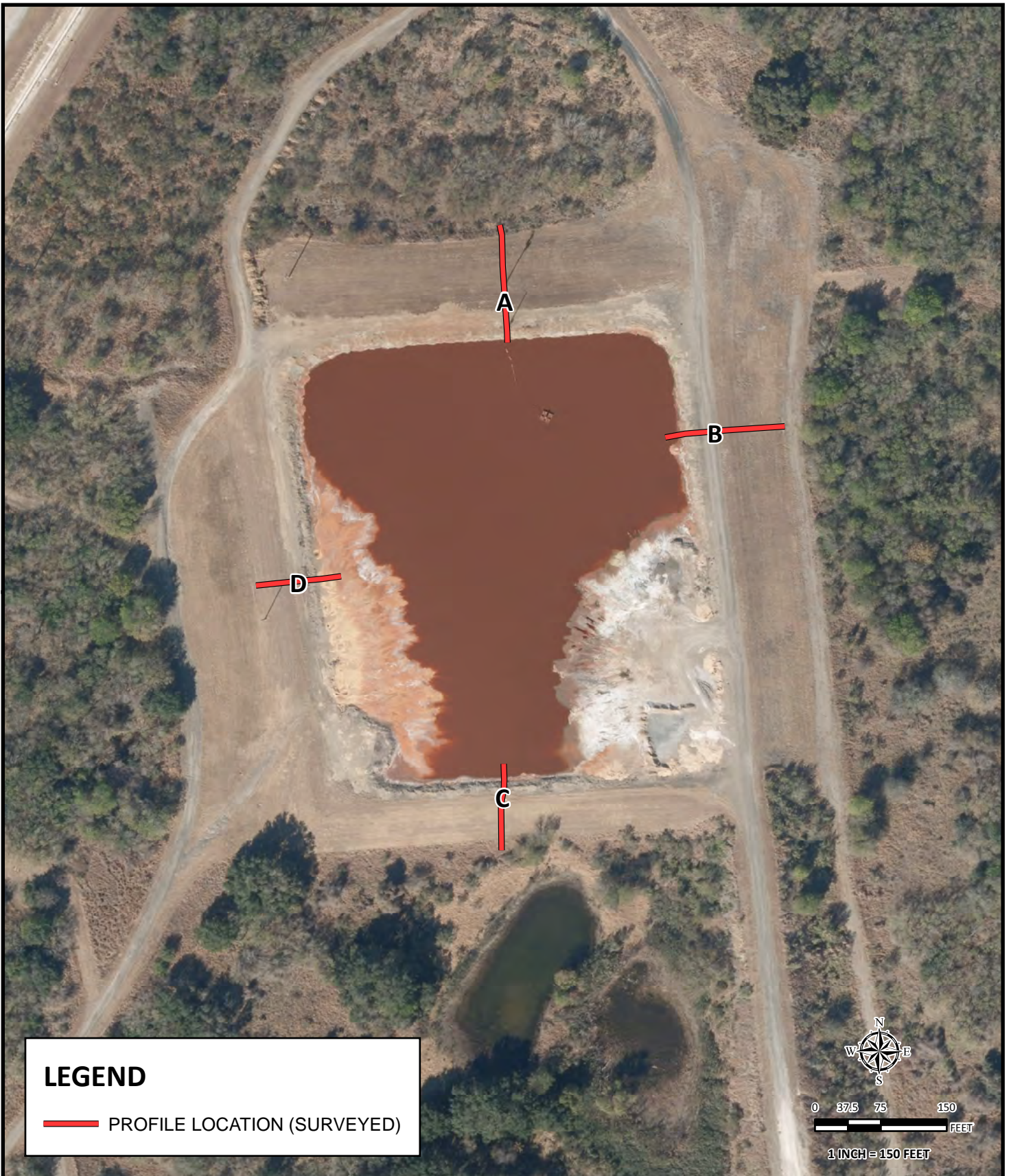

LEGEND

— PROFILE LOCATION (SURVEYED)

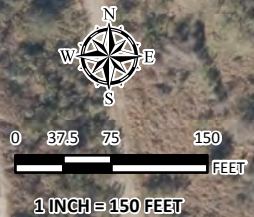

RABA KISTNER CONSULTANTS

Raba Kistner Consultants, Inc.
 12821 West Golden Lane
 San Antonio, Texas 78249
 P 210 :: 699 :: 9090
 F 210 :: 699 :: 6426
 www.rkci.com
 TBPE Firm Number 3257

SOURCE: 2011 Aerial Photograph Provided by the City of San Antonio (COSA)

SLOPE PROFILE LOCATION MAP

ASH POND BERMS - SPRUCE/DEELY GENERATION UNITS
 SAN ANTONIO, TEXAS

REVISIONS:		
No.	DATE	DESCRIPTION

PROJECT No.:
 ASA12-098-00

ISSUE DATE: 11/08/2012
 DRAWN BY: CCL
 CHECKED BY: RBW
 REVIEWED BY: GLB

FIGURE

C-1a

NOTE: This Drawing is Provided for Illustration Only, May Not be to Scale and is Not Suitable for Design or Construction Purposes



LEGEND

- PROFILE LOCATION (SURVEYED)
- PROFILE LOCATION (NOT SURVEYED)



0 50 100 200
FEET

1 INCH = 200 FEET



Raba Kistner Consultants, Inc.
12821 West Golden Lane
San Antonio, Texas 78249
P 210 :: 699 :: 9090
F 210 :: 699 :: 6426
www.rkci.com
TBPE Firm Number 3257

SOURCE: 2011 Aerial Photograph Provided by the City of San Antonio (COSA)

SLOPE PROFILE LOCATION MAP

ASH POND BERMS - SPRUCE/DEELY GENERATION UNITS
SAN ANTONIO, TEXAS



REVISIONS:
No. DATE DESCRIPTION

No.	DATE	DESCRIPTION

PROJECT No.: ASA12-098-00	
ISSUE DATE:	11/20/2012
DRAWN BY:	CCL
CHECKED BY:	RBW
REVIEWED BY:	GLB

FIGURE
C-1b

Global Stability Analysis

Material Name	Color	Unit Weight (lbs/ft ³)	Strength Type	Shear Normal Function
Embankment Fill		120	Shear Normal function	Pond 3 Embankment Soil
Clayey Sand		120	Shear Normal function	Pond 3 Clayey Sand

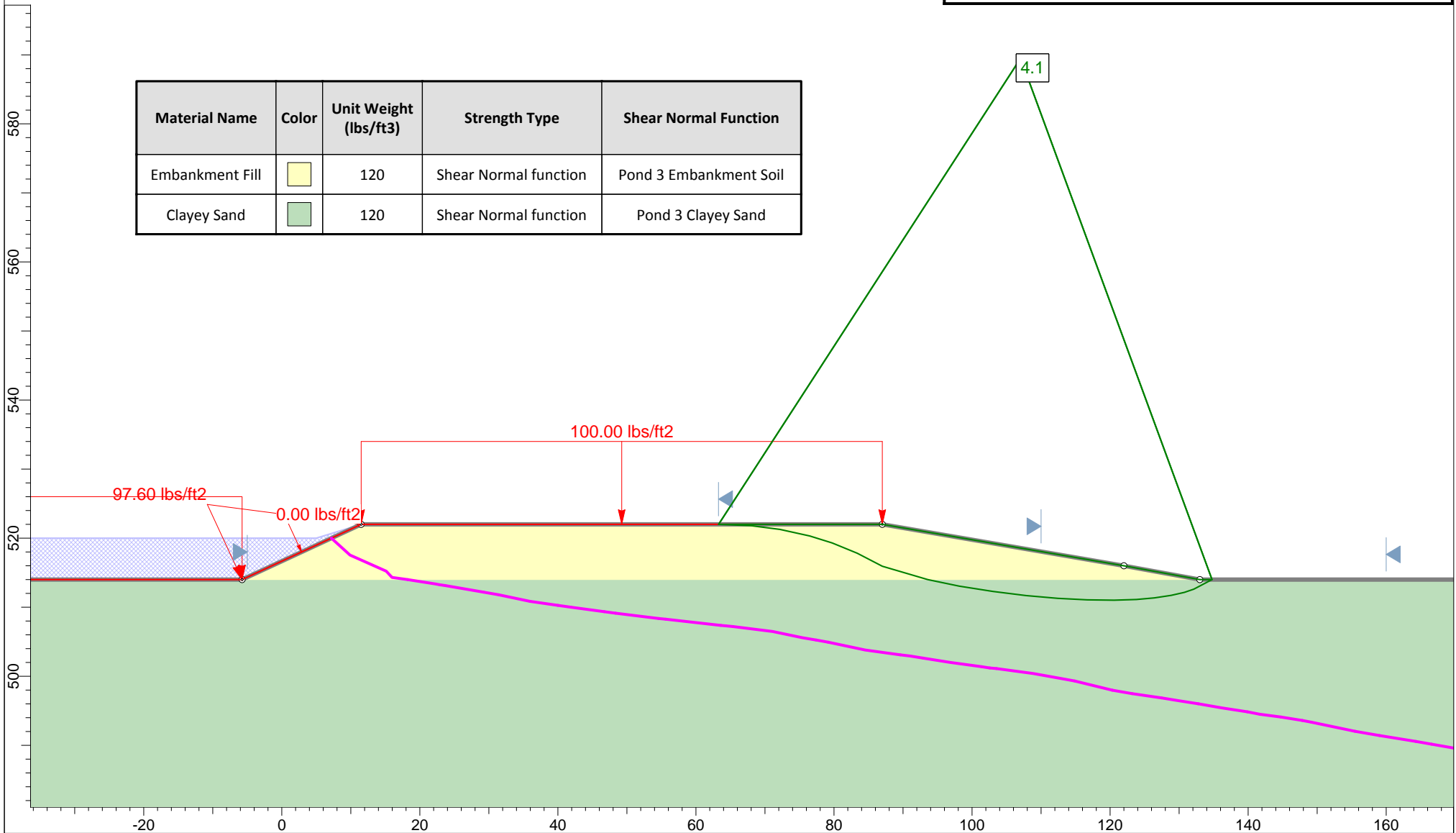



Profile "A" - Steady State
Ash Pond Berms - Spruce/Deely Generation Units

Raba Kistner Consultants, Inc.
ASA12-098-00

Figure C-2a



Global Stability Analysis

Material Name	Color	Unit Weight (lbs/ft3)	Strength Type	Shear Normal Function
Embankment Fill		120	Shear Normal function	Pond 3 Embankment Soil
Clayey Sand		120	Shear Normal function	Pond 3 Clayey Sand

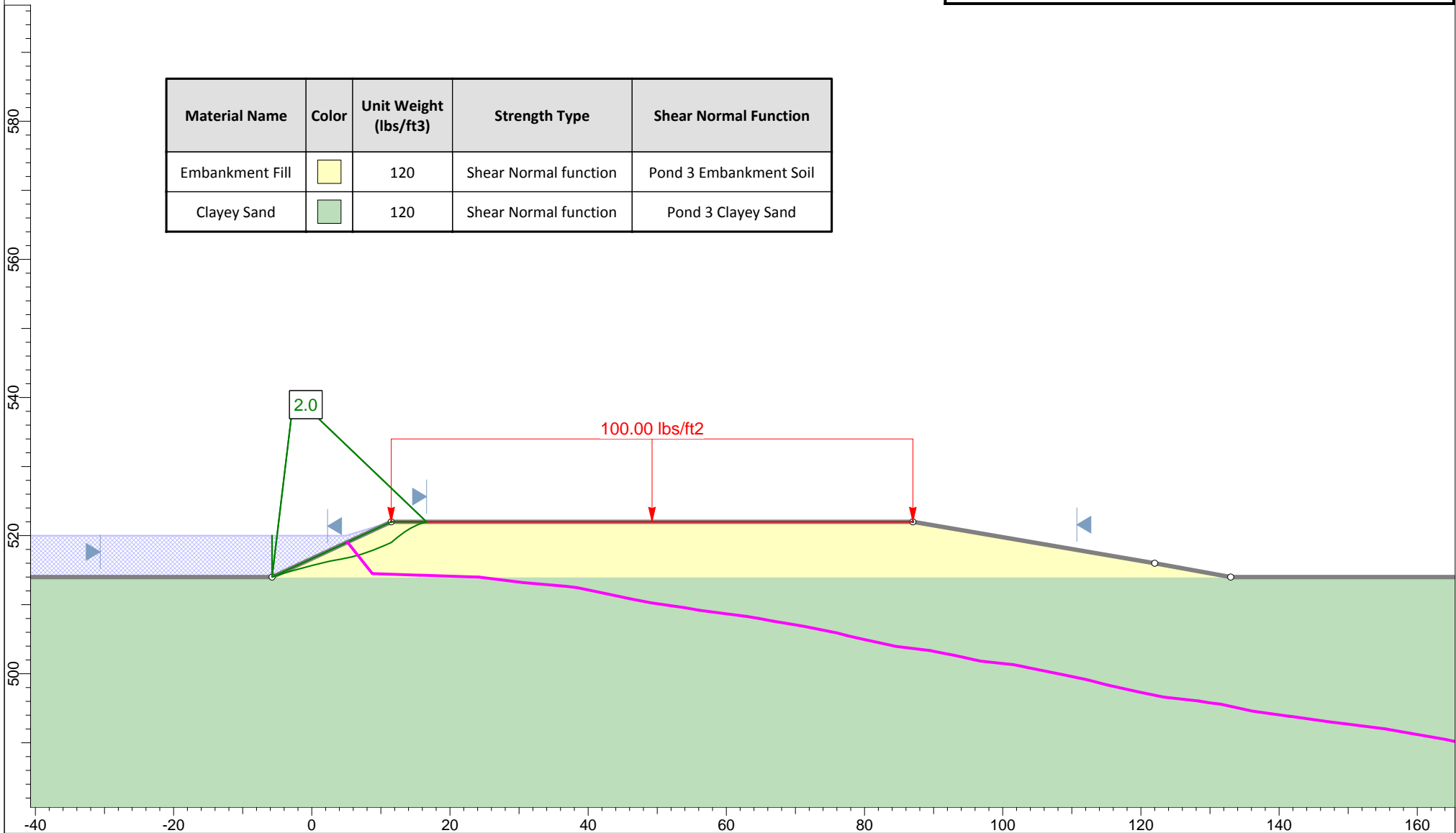



Profile "A" - Steady State
Ash Pond Berms - Spruce/Deely Generation Units

Raba Kistner Consultants, Inc.
ASA12-098-00

Figure C-2b



Global Stability Analysis

Material Name	Color	Unit Weight (lbs/ft ³)	Strength Type	Shear Normal Function
Embankment Fill		120	Shear Normal function	Pond 3 Embankment Soil
Clayey Sand		120	Shear Normal function	Pond 3 Clayey Sand
Sandy Clay		120	Shear Normal function	Pond 3 Sandy Clay

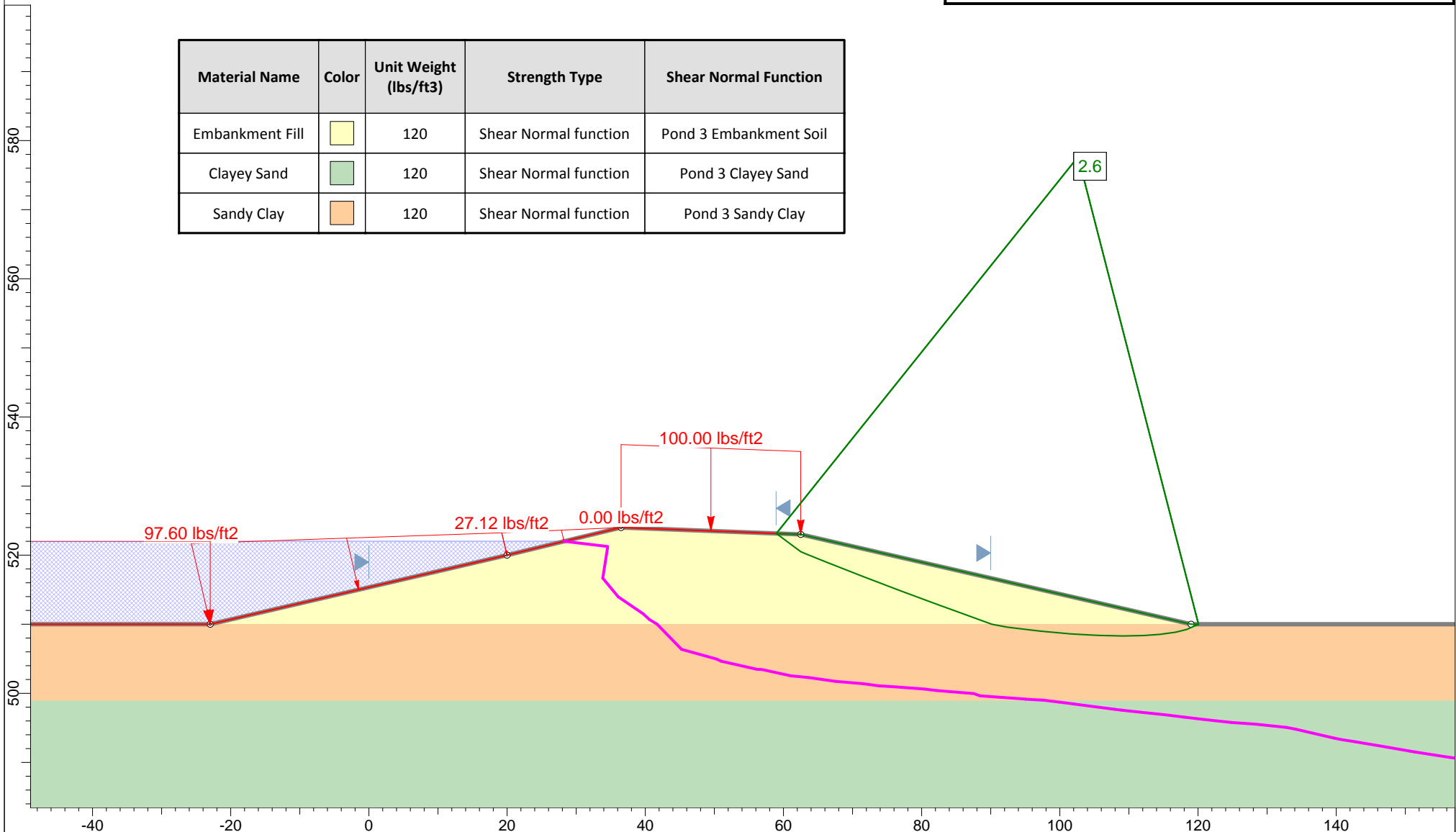



Profile "B" - Steady State
Ash Pond Berms - Spruce/Deely Generation Units

Raba Kistner Consultants, Inc.
ASA12-098-00

Figure C-3a



Global Stability Analysis

Material Name	Color	Unit Weight (lbs/ft ³)	Strength Type	Shear Normal Function
Embankment Fill		120	Shear Normal function	Pond 3 Embankment Soil
Clayey Sand		120	Shear Normal function	Pond 3 Clayey Sand
Sandy Clay		120	Shear Normal function	Pond 3 Sandy Clay

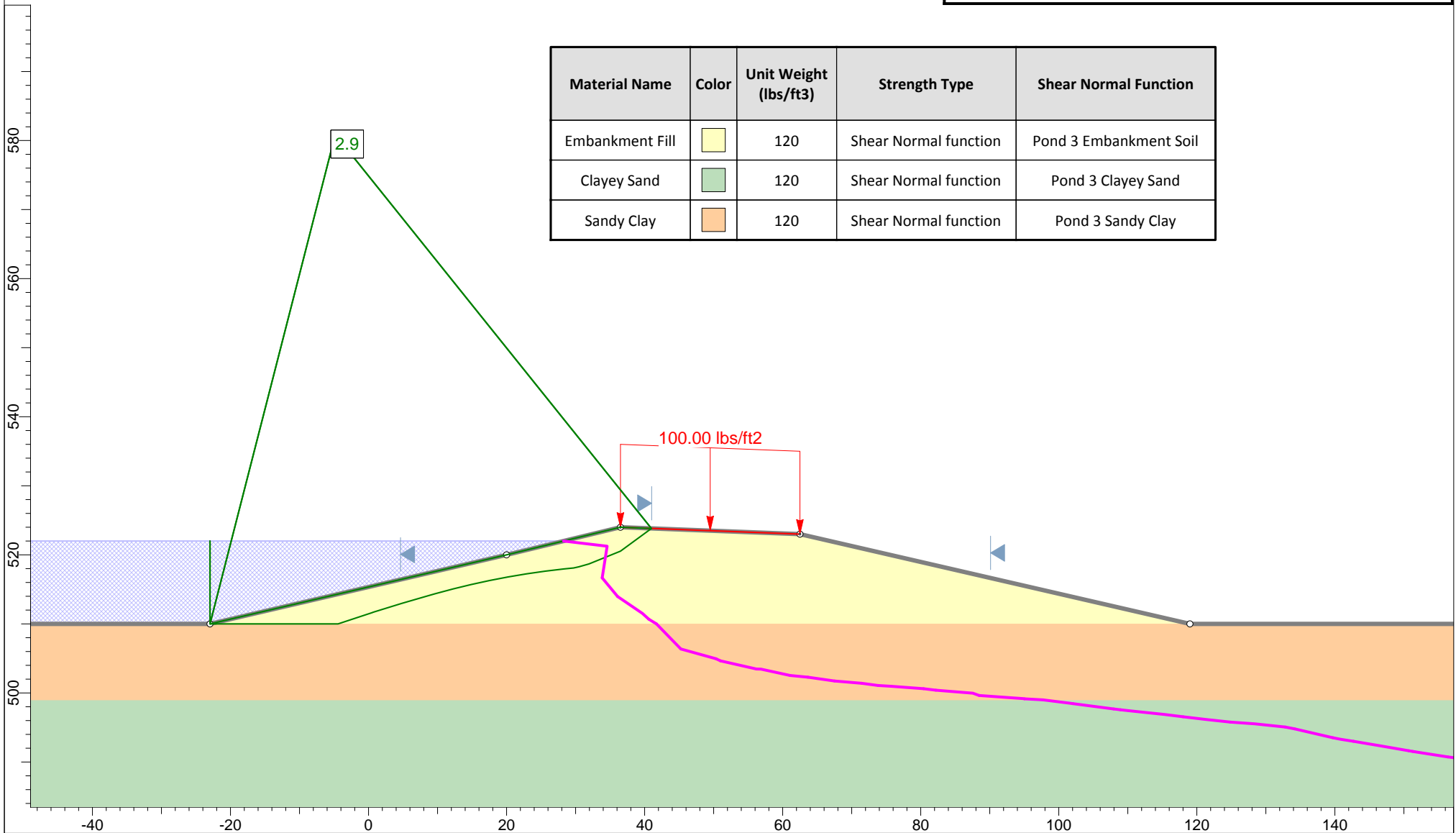

Profile "B" - Steady State
Ash Pond Berms - Spruce/Deely Generation Units

Raba Kistner Consultants, Inc.
ASA12-098-00

Figure C-3b



Global Stability Analysis

Material Name	Color	Unit Weight (lbs/ft ³)	Strength Type	Shear Normal Function
Embankment Fill	Yellow	120	Shear Normal function	Pond 3 Embankment Soil
Clayey Sand	Green	120	Shear Normal function	Pond 3 Clayey Sand

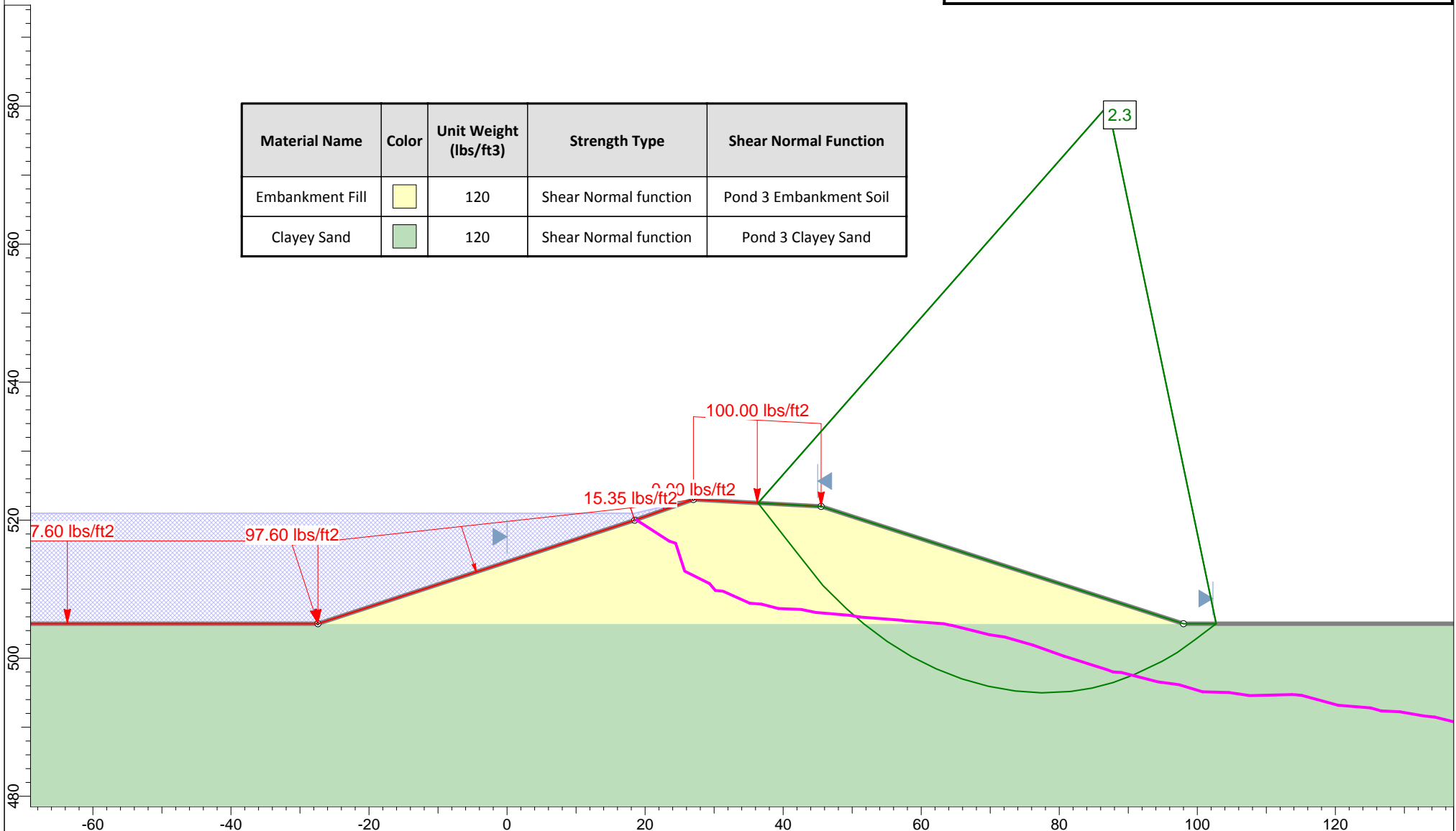



Profile "C" - Steady State
Ash Pond Berms - Spruce/Deely Generation Units

Raba Kistner Consultants, Inc.
ASA12-098-00

Figure C-4a



Global Stability Analysis

Material Name	Color	Unit Weight (lbs/ft ³)	Strength Type	Shear Normal Function
Embankment Fill		120	Shear Normal function	Pond 3 Embankment Soil
Clayey Sand		120	Shear Normal function	Pond 3 Clayey Sand

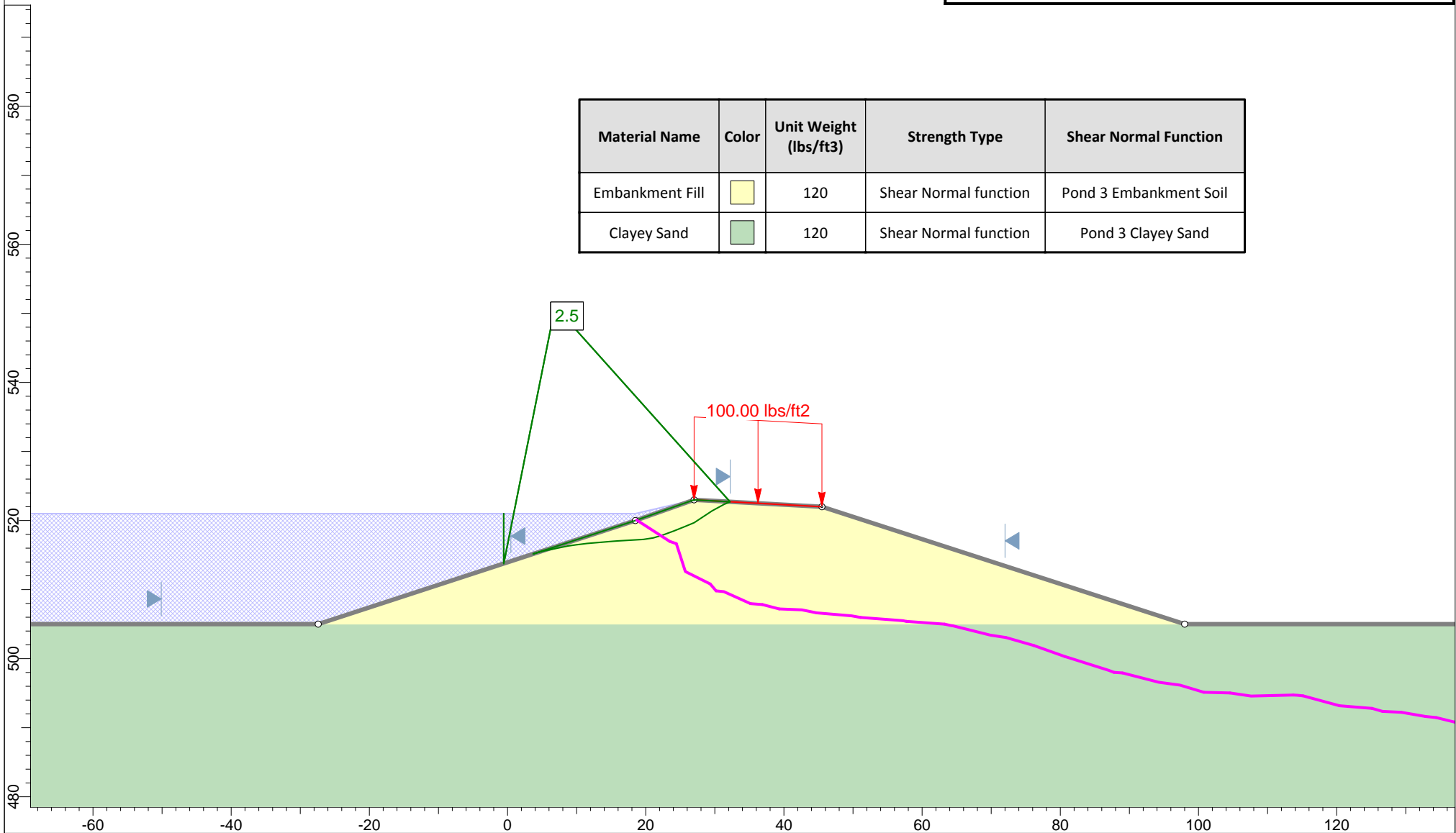



Profile "C" - Steady State
Ash Pond Berms - Spruce/Deely Generation Units

Raba Kistner Consultants, Inc.
ASA12-098-00

Figure C-4b



Global Stability Analysis

Material Name	Color	Unit Weight (lbs/ft ³)	Strength Type	Shear Normal Function
Embankment Fill		120	Shear Normal function	Pond 3 Embankment Soil
Clayey Sand		120	Shear Normal function	Pond 3 Clayey Sand
Sandy Clay		120	Shear Normal function	Pond 3 Sandy Clay

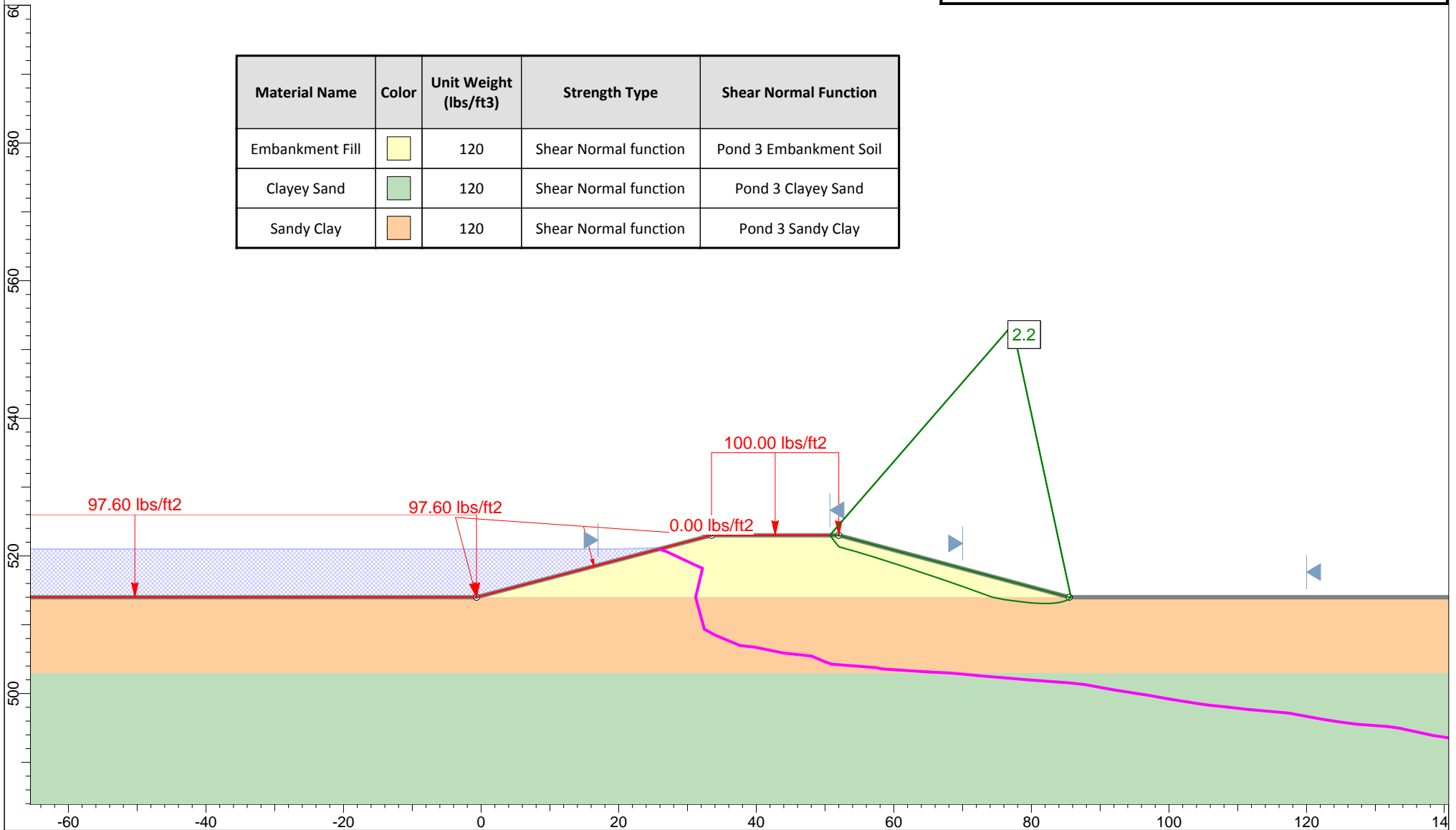



Profile "D" - Steady State
Ash Pond Berms - Spruce/Deely Generation Units

Raba Kistner Consultants, Inc.
ASA12-098-00

Figure C-5a



Global Stability Analysis

Material Name	Color	Unit Weight (lbs/ft ³)	Strength Type	Shear Normal Function
Embankment Fill		120	Shear Normal function	Pond 3 Embankment Soil
Clayey Sand		120	Shear Normal function	Pond 3 Clayey Sand
Sandy Clay		120	Shear Normal function	Pond 3 Sandy Clay

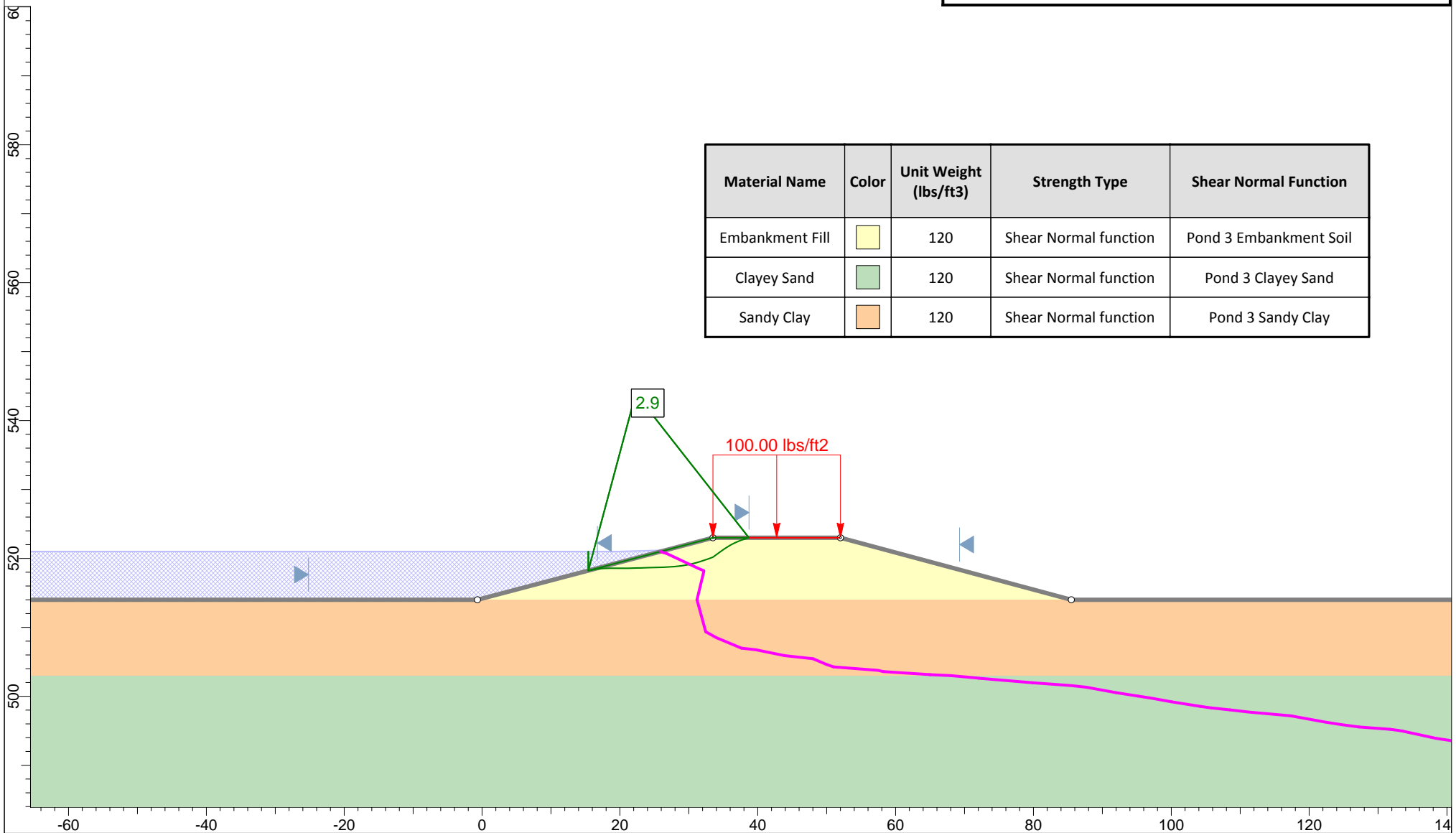



Profile "D" - Steady State
Ash Pond Berms - Spruce/Deely Generation Units

Raba Kistner Consultants, Inc.
ASA12-098-00

Figure C-5b



Global Stability Analysis

Material Name	Color	Unit Weight (lbs/ft ³)	Strength Type	Shear Normal Function
Embankment Soil		120	Shear Normal function	Pond 2 Embankment Soil
Clayey Sand		120	Shear Normal function	Pond 2 Clayey Sand
Sandy Clay		120	Shear Normal function	Pond 2 Sandy Clay

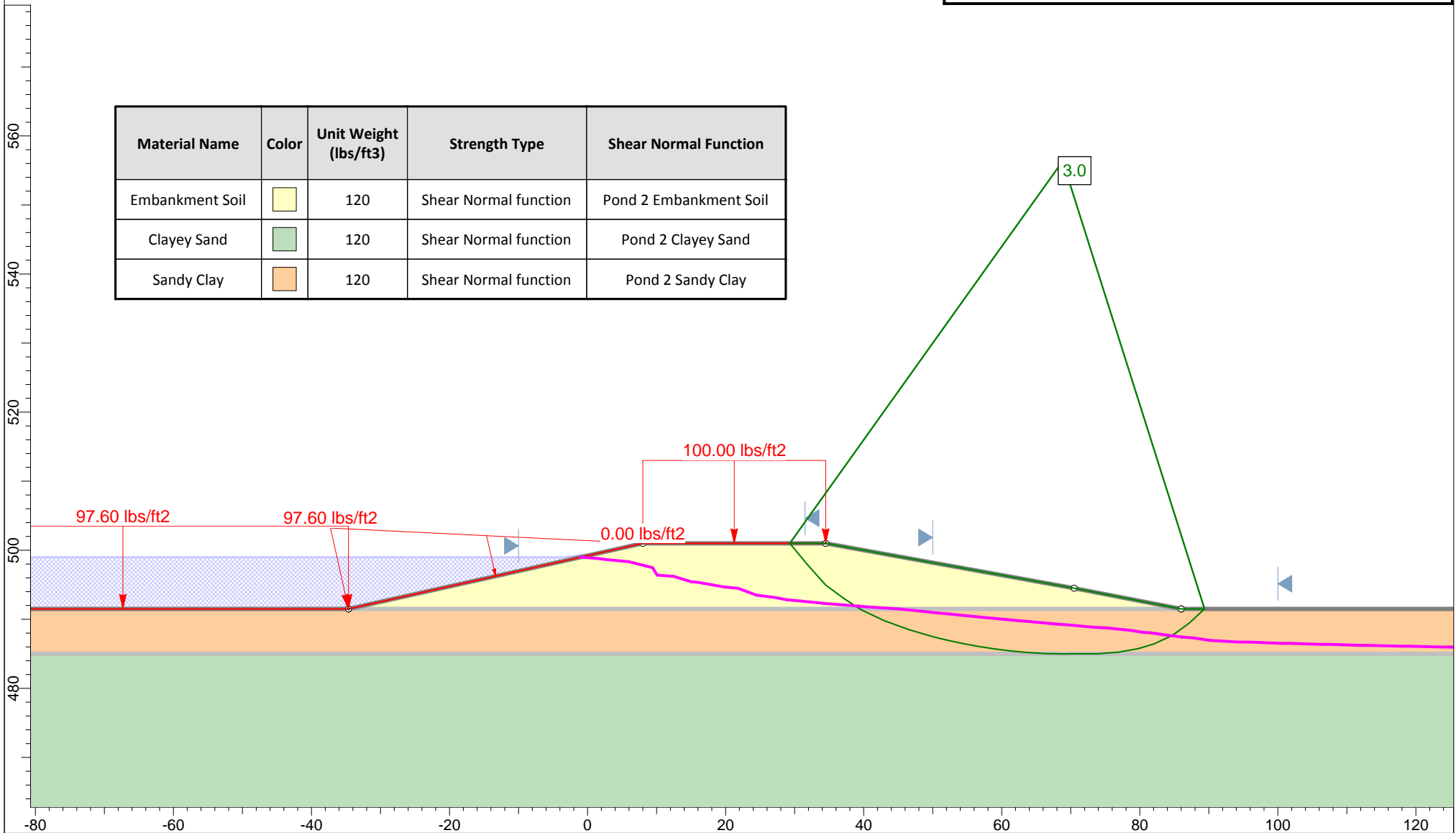

Profile "E" - Steady State
Ash Pond Berms - Spruce/Deely Generation Units

Raba Kistner Consultants, Inc.
ASA12-098-00

Figure C-6a



Global Stability Analysis

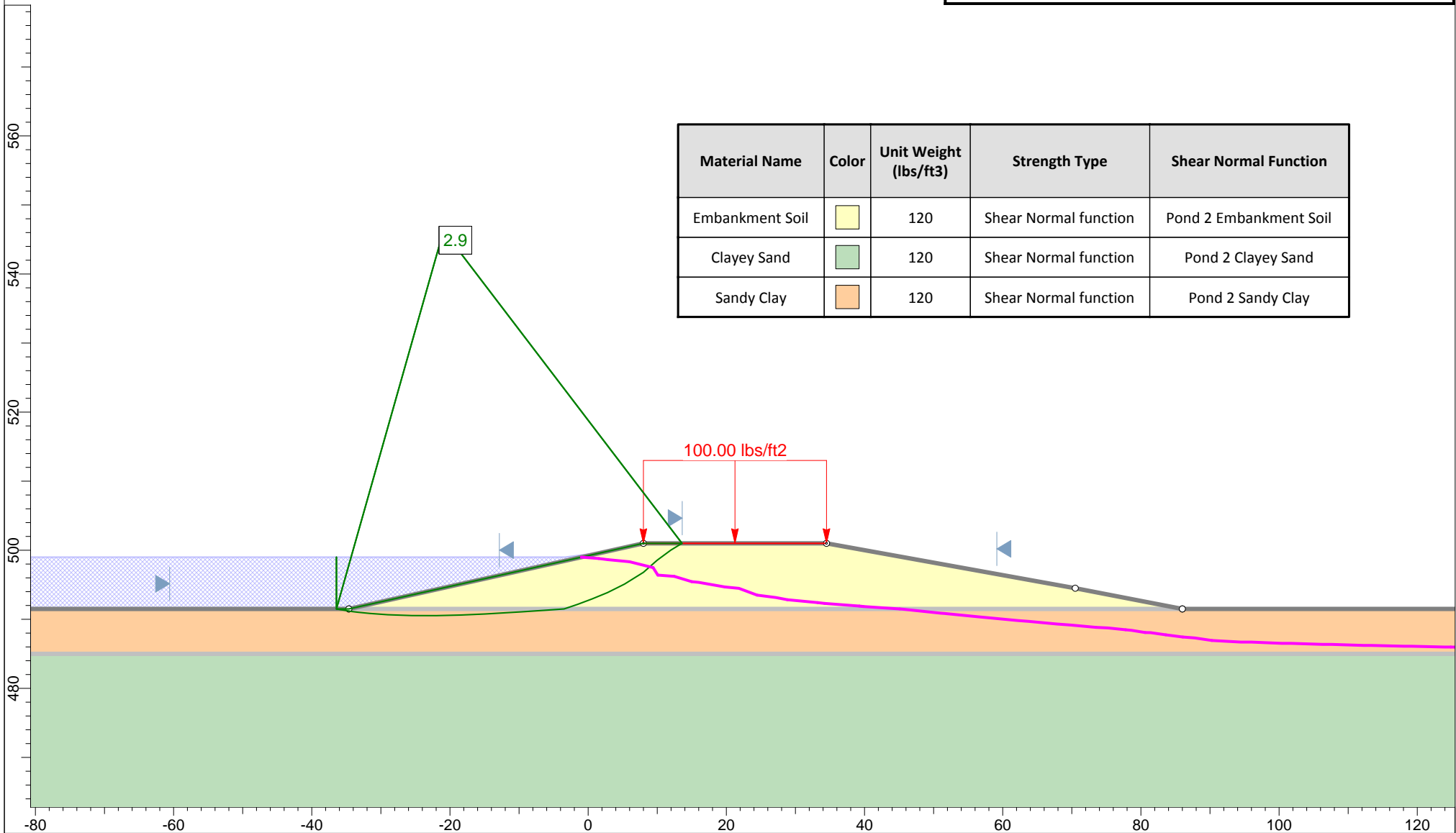

Material Name	Color	Unit Weight (lbs/ft ³)	Strength Type	Shear Normal Function
Embankment Soil		120	Shear Normal function	Pond 2 Embankment Soil
Clayey Sand		120	Shear Normal function	Pond 2 Clayey Sand
Sandy Clay		120	Shear Normal function	Pond 2 Sandy Clay



Profile "E" - Steady State
Ash Pond Berms - Spruce/Deely Generation Units

Raba Kistner Consultants, Inc.
ASA12-098-00

Figure C-6b



Global Stability Analysis

Material Name	Color	Unit Weight (lbs/ft ³)	Strength Type	Shear Normal Function
Embankment Fill		120	Shear Normal function	Pond 2 Embankment Soil
Clayey Sand		120	Shear Normal function	Pond 2 Clayey Sand
Sandy Clay		120	Shear Normal function	Pond 2 Sandy Clay

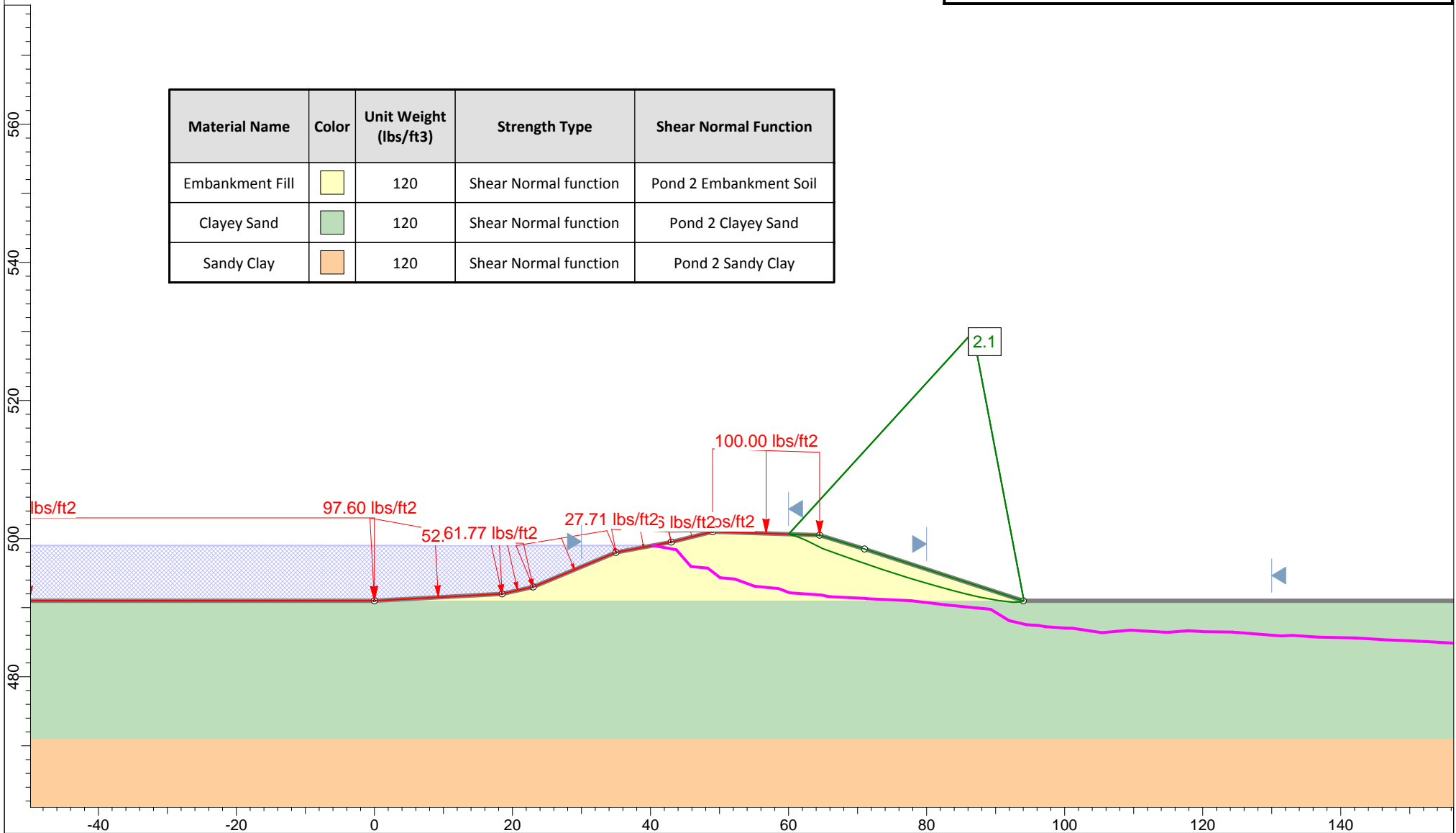



Profile "F" - Steady State
Ash Pond Berms - Spruce/Deely Generation Units

Raba Kistner Consultants, Inc.
ASA12-098-00

Figure C-7a



Global Stability Analysis

Material Name	Color	Unit Weight (lbs/ft ³)	Strength Type	Shear Normal Function
Embankment Fill		120	Shear Normal function	Pond 2 Embankment Soil
Clayey Sand		120	Shear Normal function	Pond 2 Clayey Sand
Sandy Clay		120	Shear Normal function	Pond 2 Sandy Clay

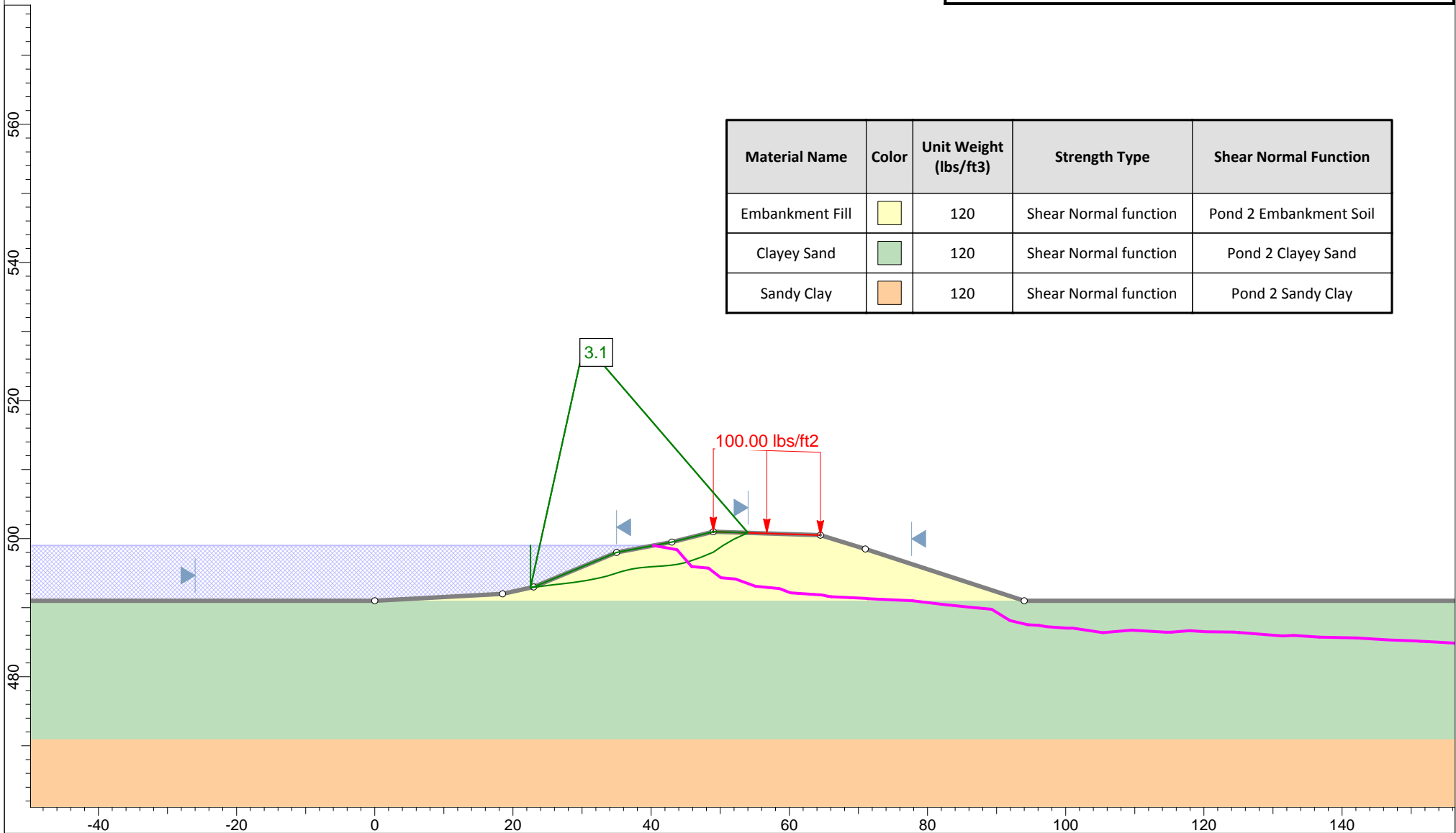



Profile "F" - Steady State
Ash Pond Berms - Spruce/Deely Generation Units

Raba Kistner Consultants, Inc.
ASA12-098-00

Figure C-7b



Global Stability Analysis

Material Name	Color	Unit Weight (lbs/ft ³)	Strength Type	Shear Normal Function
Embankment Fill		120	Shear Normal function	Pond 2 Embankment Soil
Clayey Sand		120	Shear Normal function	Pond 2 Clayey Sand
Sandy Clay		120	Shear Normal function	Pond 2 Sandy Clay

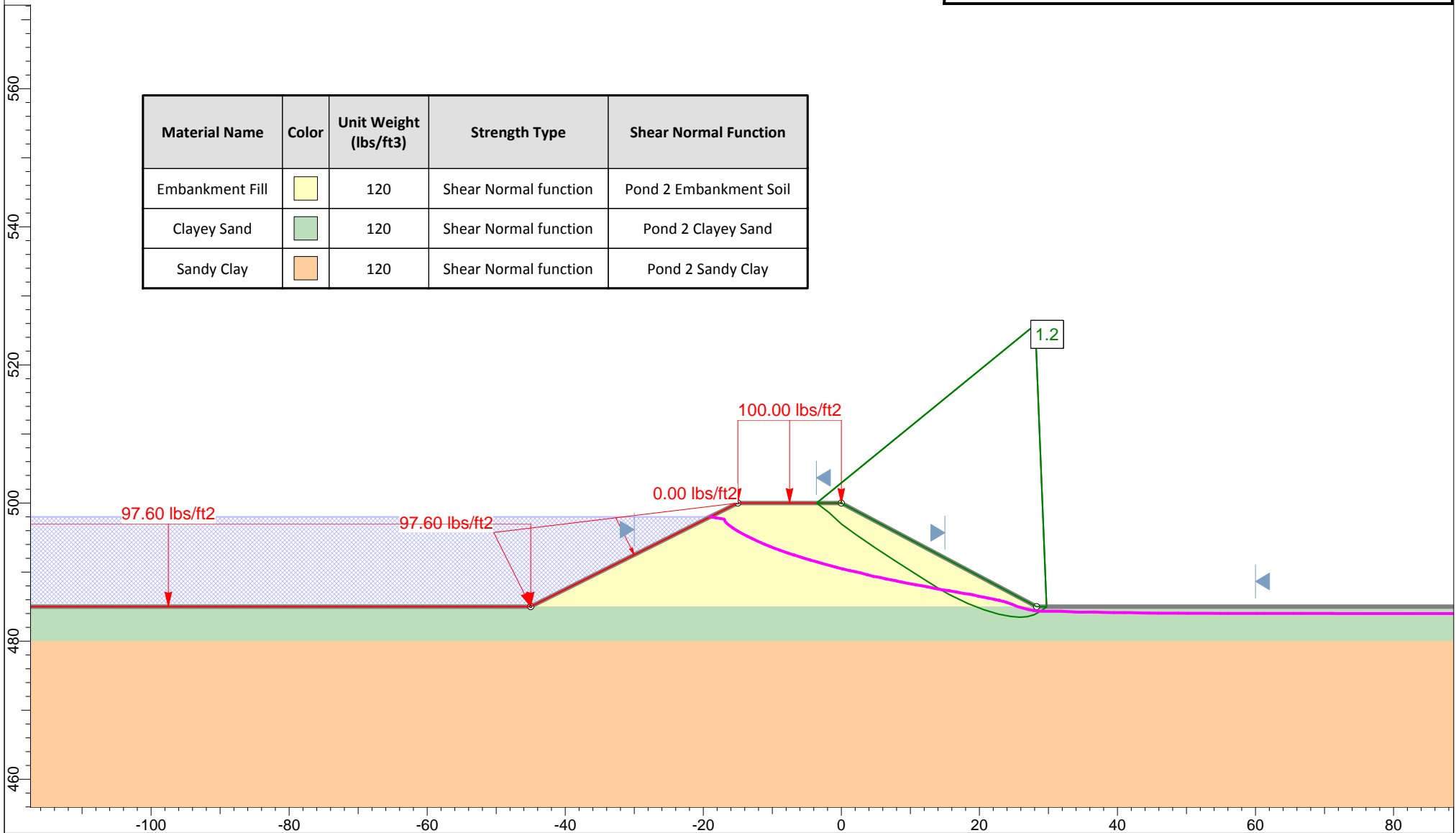



Profile "G" - Steady State
Ash Pond Berms - Spruce/Deely Generation Units

Raba Kistner Consultants, Inc.
ASA12-098-00

Figure C-8a



Global Stability Analysis

Material Name	Color	Unit Weight (lbs/ft ³)	Strength Type	Shear Normal Function
Embankment Fill		120	Shear Normal function	Pond 2 Embankment Soil
Clayey Sand		120	Shear Normal function	Pond 2 Clayey Sand
Sandy Clay		120	Shear Normal function	Pond 2 Sandy Clay

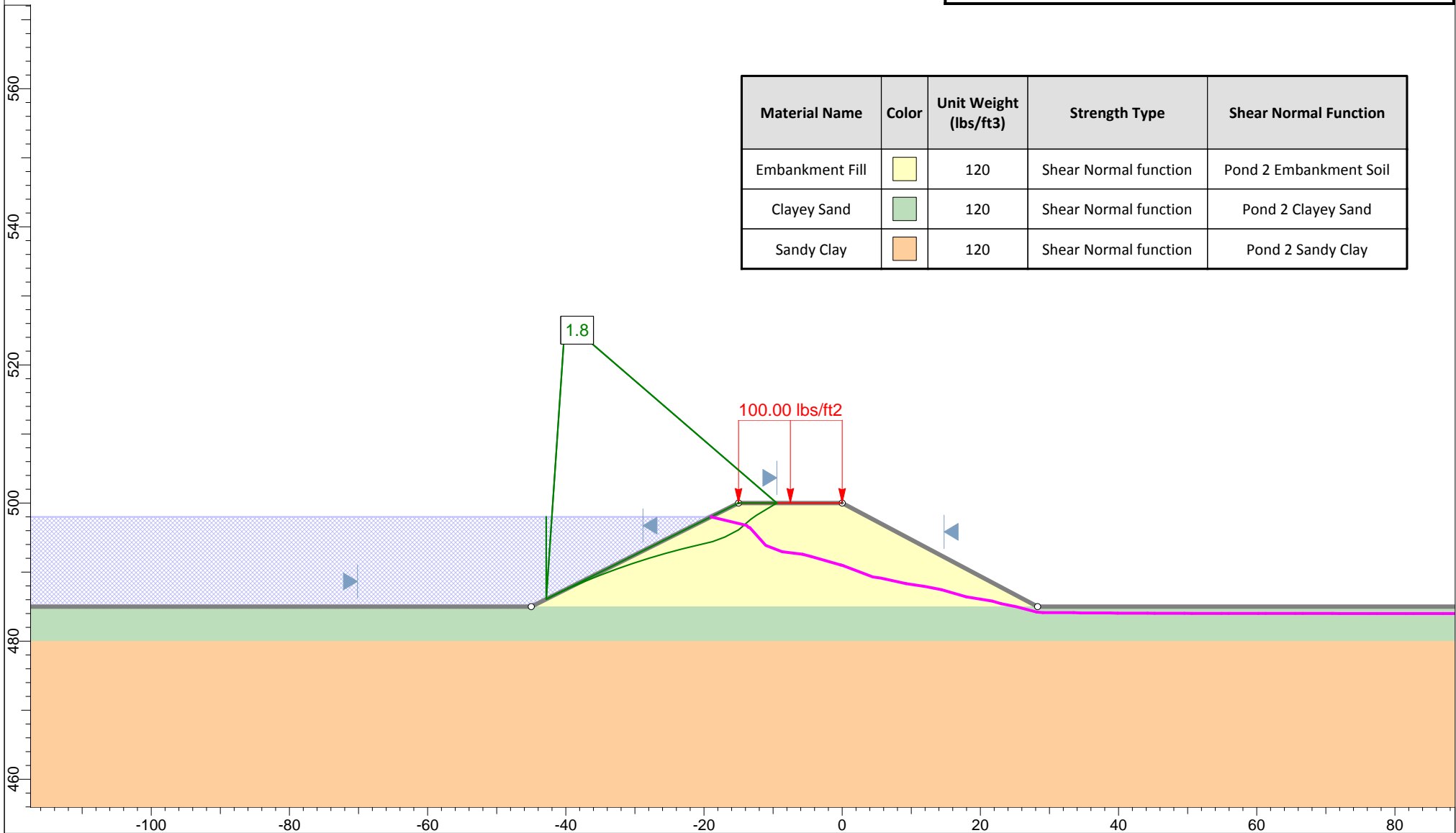



Profile "G" - Steady State
Ash Pond Berms - Spruce/Deely Generation Units

Raba Kistner Consultants, Inc.
ASA12-098-00

Figure C-8b



Global Stability Analysis

Material Name	Color	Unit Weight (lbs/ft ³)	Strength Type	Shear Normal Function
Embankment Fill		120	Shear Normal function	Pond 2 Embankment Soil
Clayey Sand		120	Shear Normal function	Pond 2 Clayey Sand
Sandy Clay		120	Shear Normal function	Pond 2 Sandy Clay

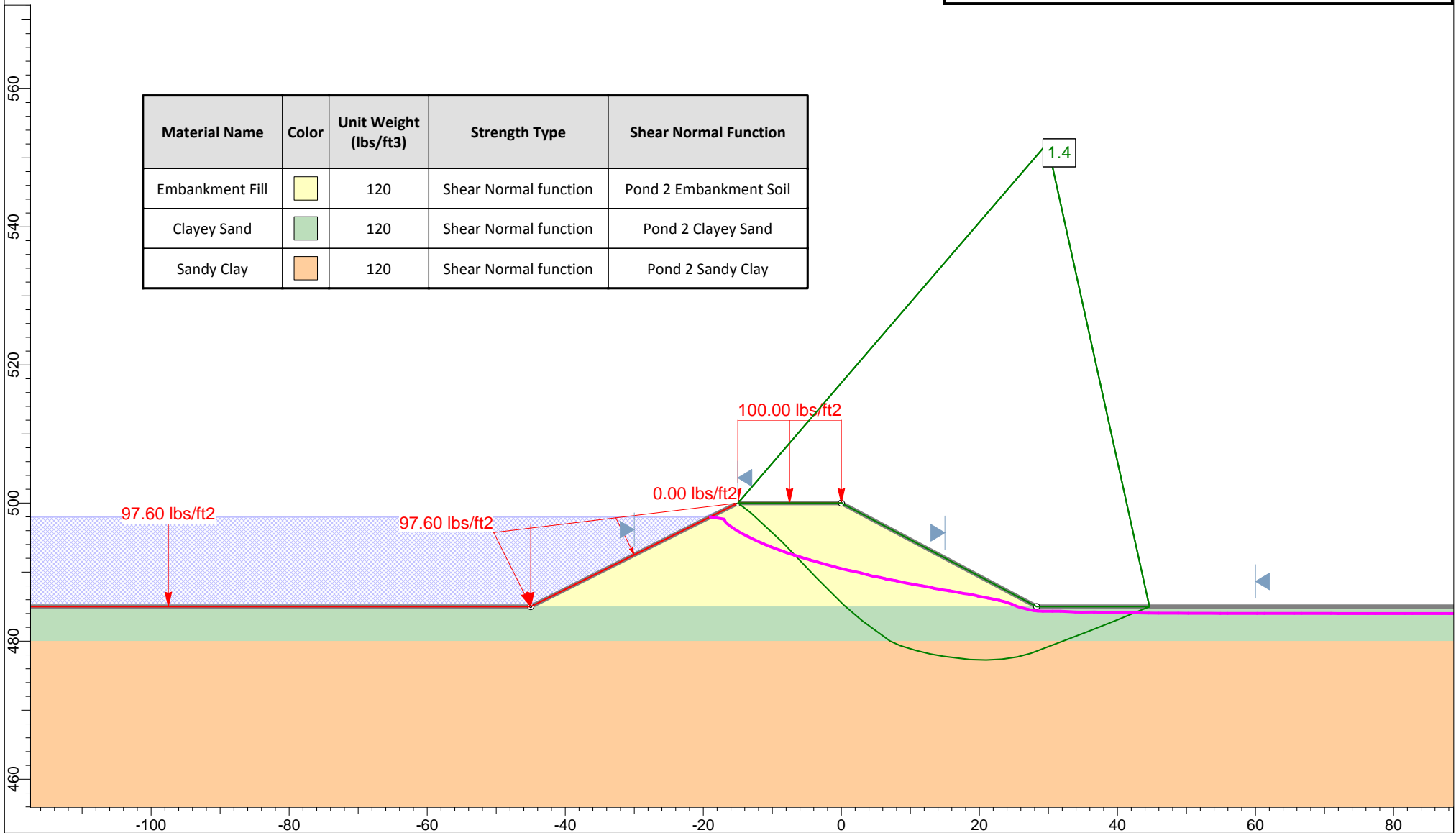



Profile "G" - Steady State
Ash Pond Berms - Spruce/Deely Generation Units

Raba Kistner Consultants, Inc.
ASA12-098-00

Figure C-8c



Global Stability Analysis

Material Name	Color	Unit Weight (lbs/ft ³)	Strength Type	Shear Normal Function
Embankment Fill		120	Shear Normal function	Pond 2 Embankment Soil
Clayey Sand		120	Shear Normal function	Pond 2 Clayey Sand
Sandy Clay		120	Shear Normal function	Pond 2 Sandy Clay

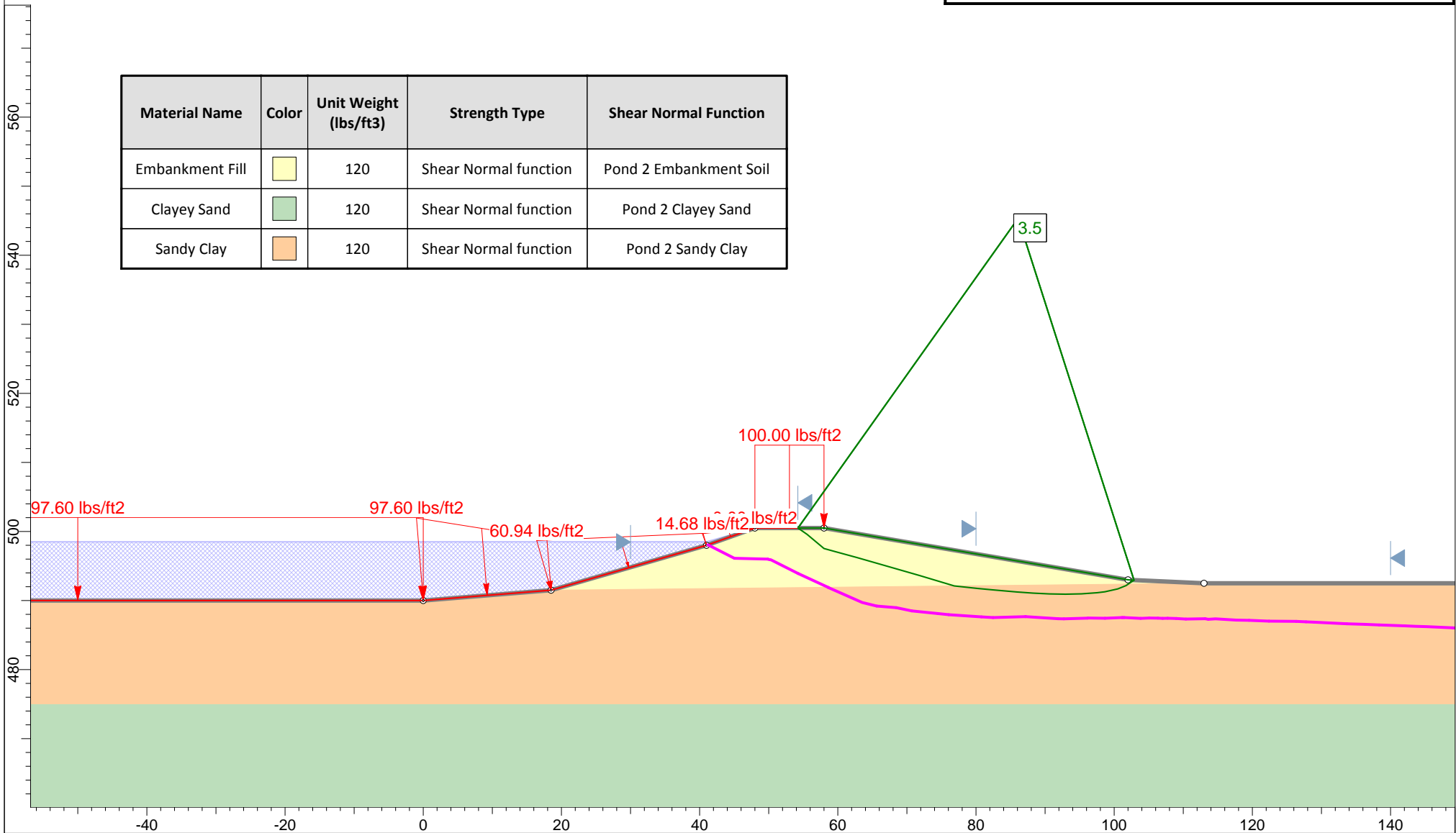



Profile "H" - Steady State
Ash Pond Berms - Spruce/Deely Generation Units

Raba Kistner Consultants, Inc.
ASA12-098-00

Figure C-9a



Global Stability Analysis

Material Name	Color	Unit Weight (lbs/ft3)	Strength Type	Shear Normal Function
Embankment Fill		120	Shear Normal function	Pond 2 Embankment Soil
Clayey Sand		120	Shear Normal function	Pond 2 Clayey Sand
Sandy Clay		120	Shear Normal function	Pond 2 Sandy Clay

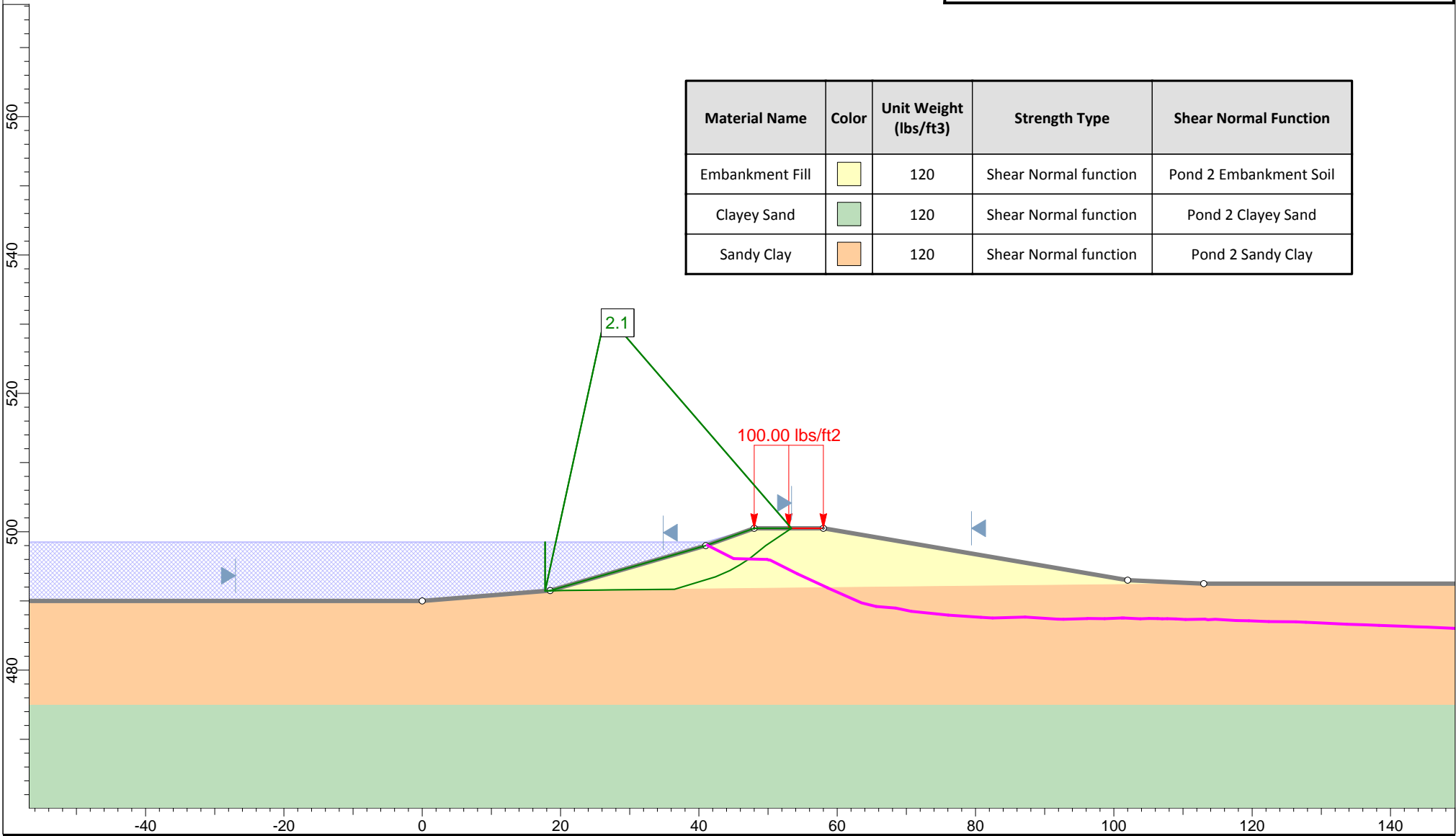



Profile "H" - Steady State
Ash Pond Berms - Spruce/Deely Generation Units

Raba Kistner Consultants, Inc.
ASA12-098-00

Figure C-9b



Global Stability Analysis

Material Name	Color	Unit Weight (lbs/ft ³)	Strength Type	Shear Normal Function
Embankment Fill		120	Shear Normal function	Pond 2 Embankment Soil
Clayey Sand		120	Shear Normal function	Pond 2 Clayey Sand
Sandy Clay		120	Shear Normal function	Pond 2 Sandy Clay

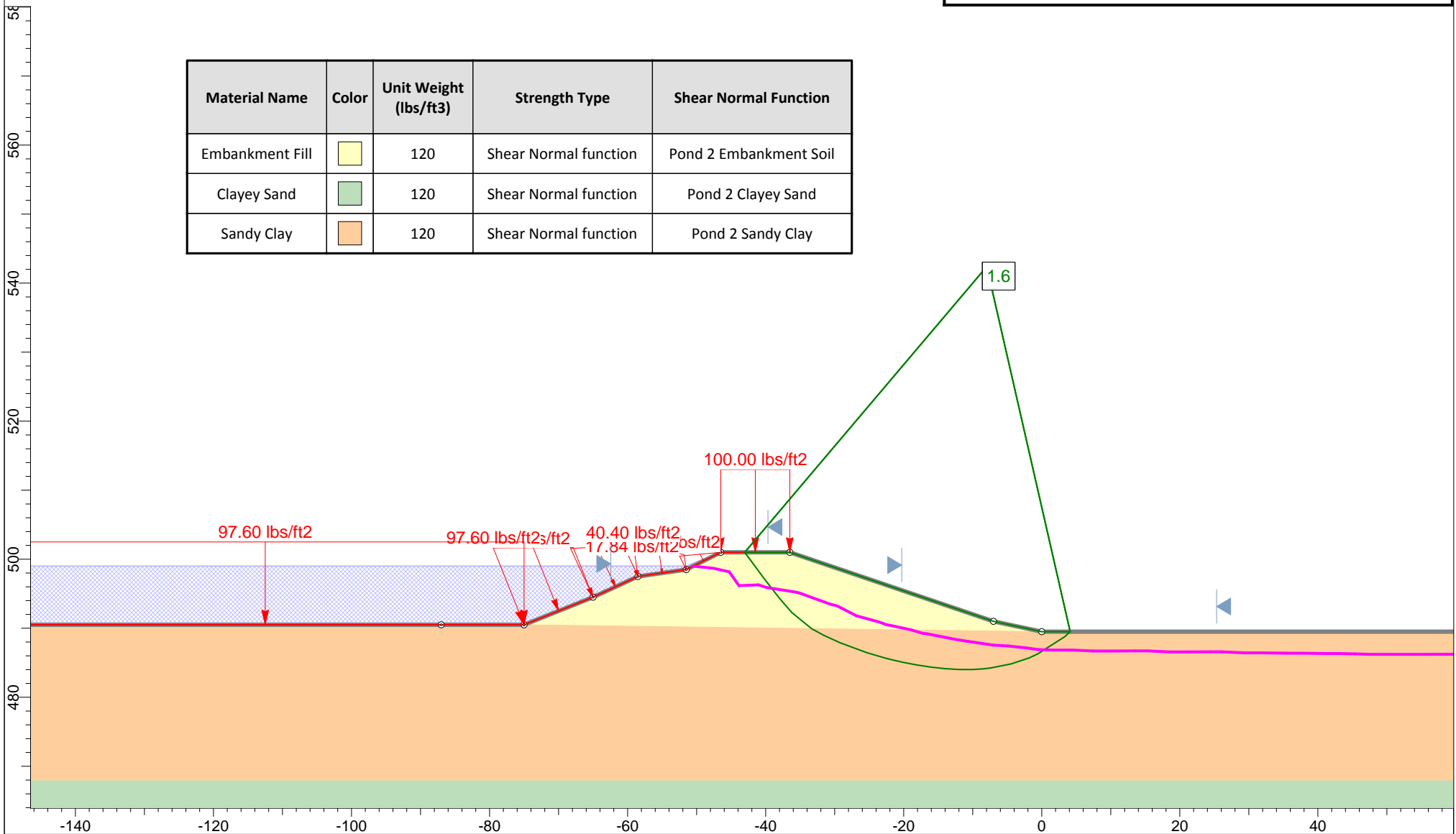



Profile "I" - Steady State
Ash Pond Berms - Spruce/Deely Generation Units

Raba Kistner Consultants, Inc.
ASA12-098-00

Figure C-10a



Global Stability Analysis

Material Name	Color	Unit Weight (lbs/ft ³)	Strength Type	Shear Normal Function
Embankment Fill		120	Shear Normal function	Pond 2 Embankment Soil
Clayey Sand		120	Shear Normal function	Pond 2 Clayey Sand
Sandy Clay		120	Shear Normal function	Pond 2 Sandy Clay

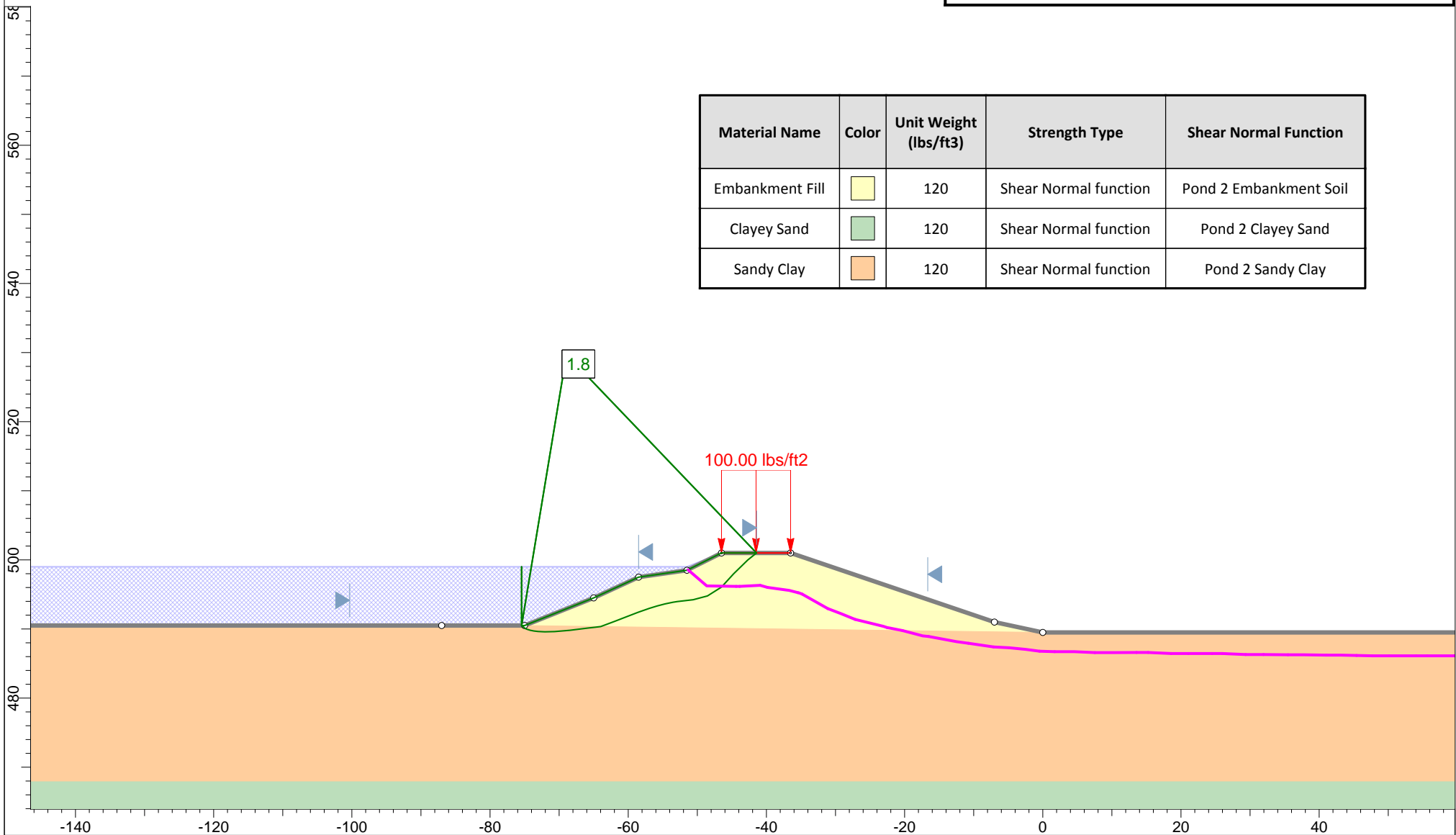



Profile "I" - Steady State
Ash Pond Berms - Spruce/Deely Generation Units

Raba Kistner Consultants, Inc.
ASA12-098-00

Figure C-10b



Global Stability Analysis

Material Name	Color	Unit Weight (lbs/ft ³)	Strength Type	Shear Normal Function
Embankment Fill		120	Shear Normal function	Pond 1 Embankment Soil
Clayey Sand		120	Shear Normal function	Pond 1 Clayey Sand

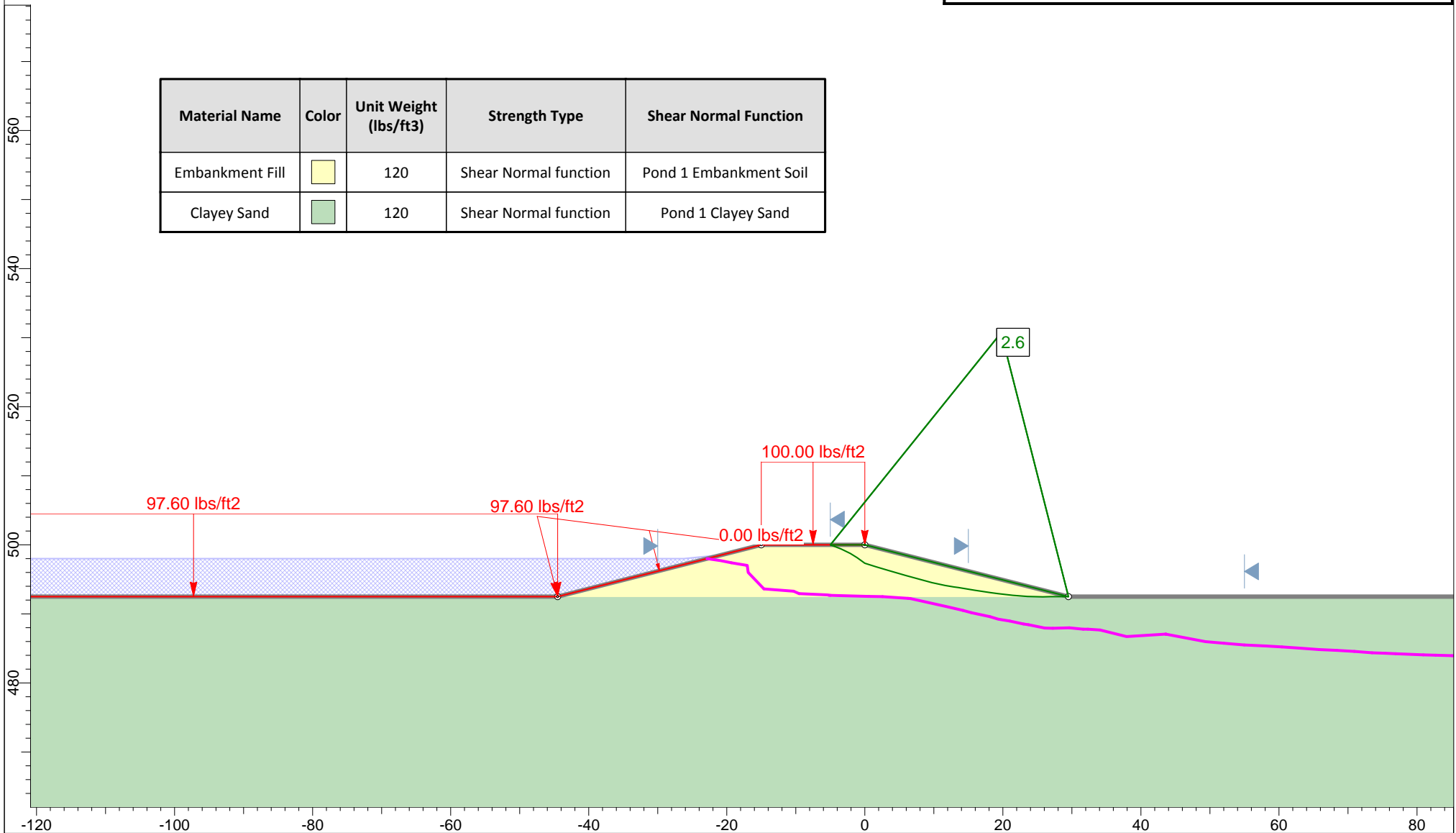



Profile "J" - Steady State
Ash Pond Berms - Spruce/Deely Generation Units

Raba Kistner Consultants, Inc.
ASA12-098-00

Figure C-11a



Global Stability Analysis

Material Name	Color	Unit Weight (lbs/ft ³)	Strength Type	Shear Normal Function
Embankment Fill		120	Shear Normal function	Pond 1 Embankment Soil
Clayey Sand		120	Shear Normal function	Pond 1 Clayey Sand

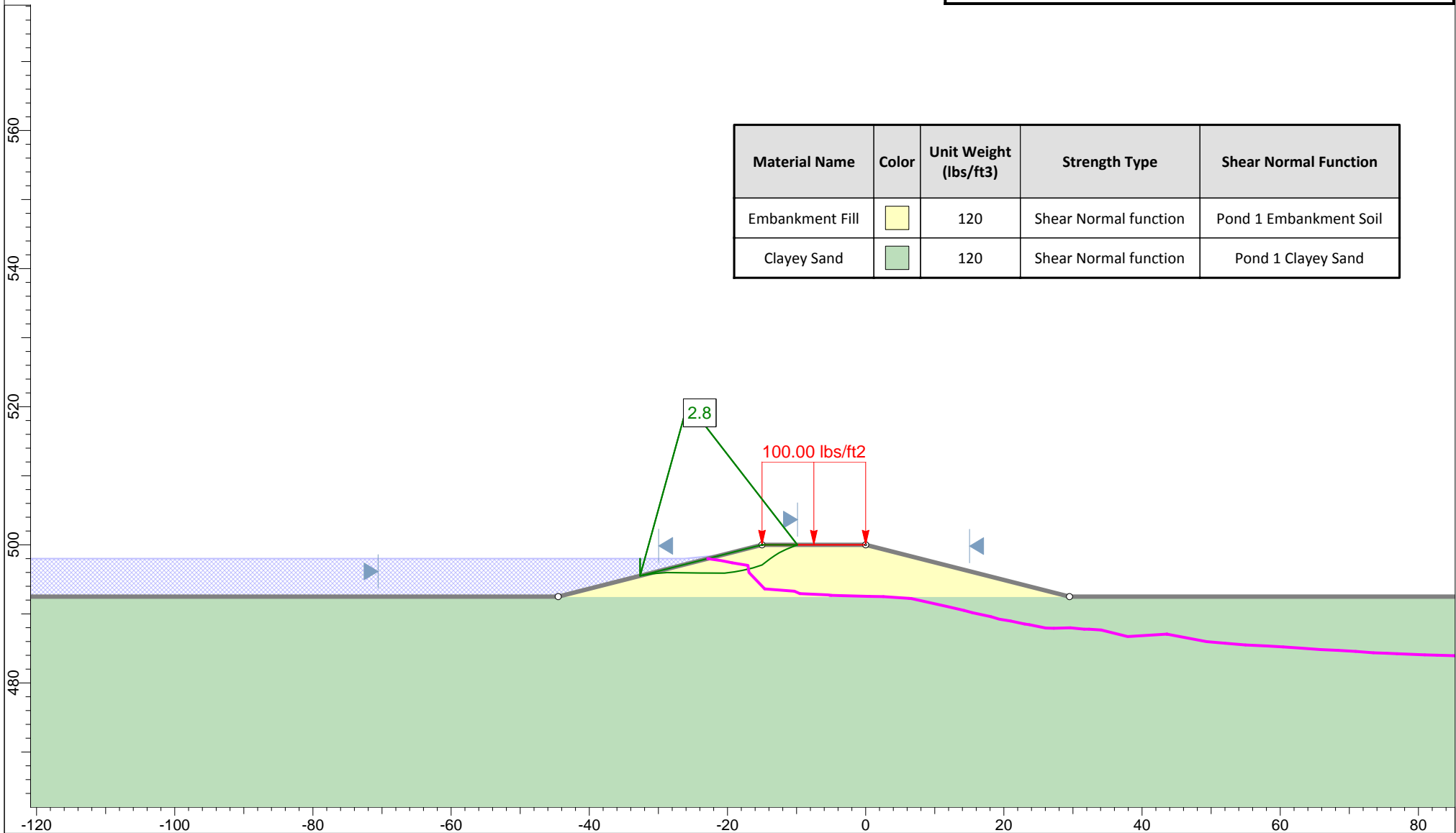



Profile "J" - Steady State
Ash Pond Berms - Spruce/Deely Generation Units

Raba Kistner Consultants, Inc.
ASA12-098-00

Figure C-11b



Global Stability Analysis

Material Name	Color	Unit Weight (lbs/ft ³)	Strength Type	Shear Normal Function
Embankment Fill		120	Shear Normal function	Pond 1 Embankment Soil
Sandy Clay		120	Shear Normal function	Pond 1 Sandy Clay

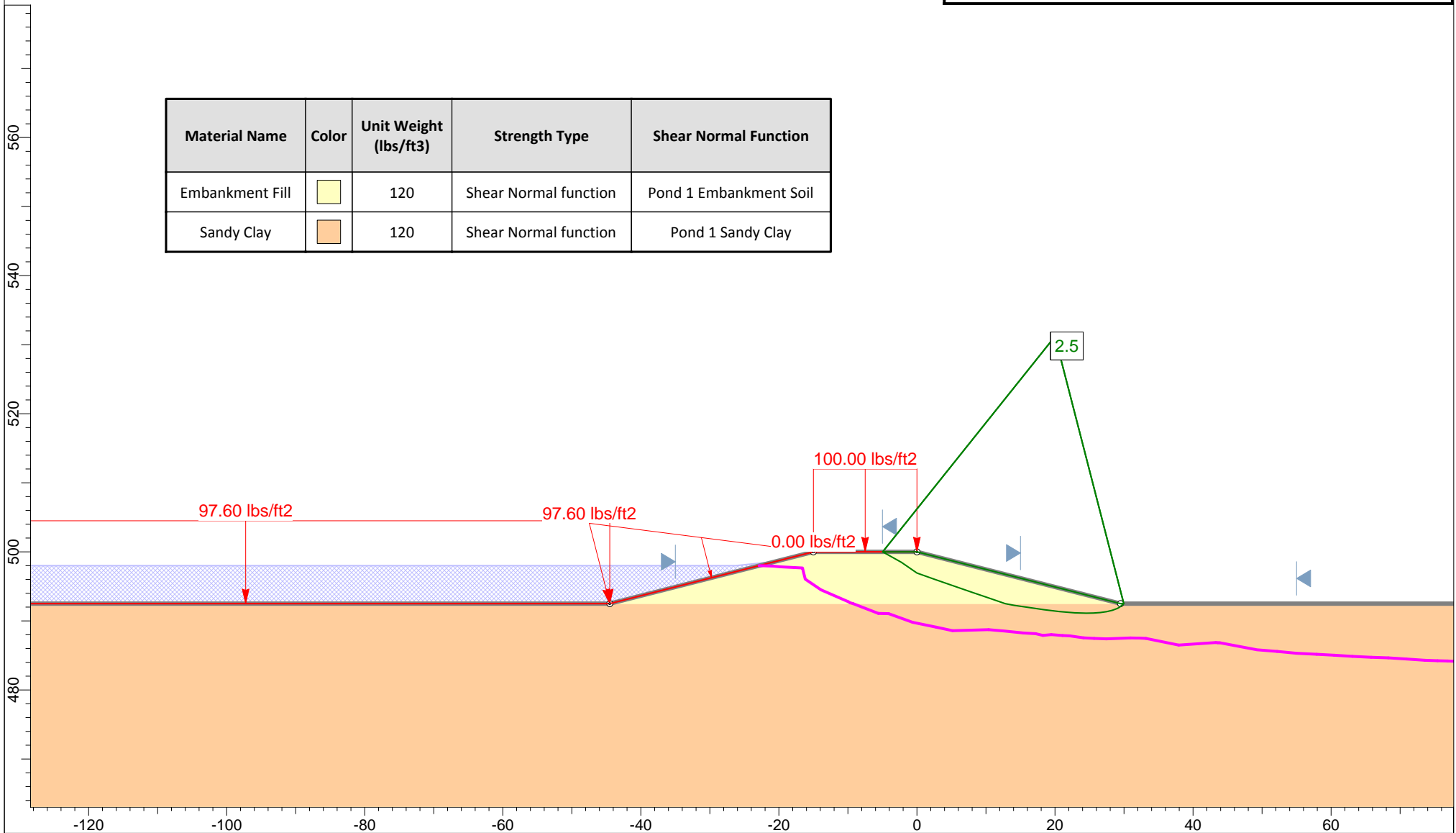



Profile "K" - Steady State
Ash Pond Berms - Spruce/Deely Generation Units

Raba Kistner Consultants, Inc.
ASA12-098-00

Figure C-12a



Global Stability Analysis

Material Name	Color	Unit Weight (lbs/ft ³)	Strength Type	Shear Normal Function
Embankment Fill		120	Shear Normal function	Pond 1 Embankment Soil
Sandy Clay		120	Shear Normal function	Pond 1 Sandy Clay

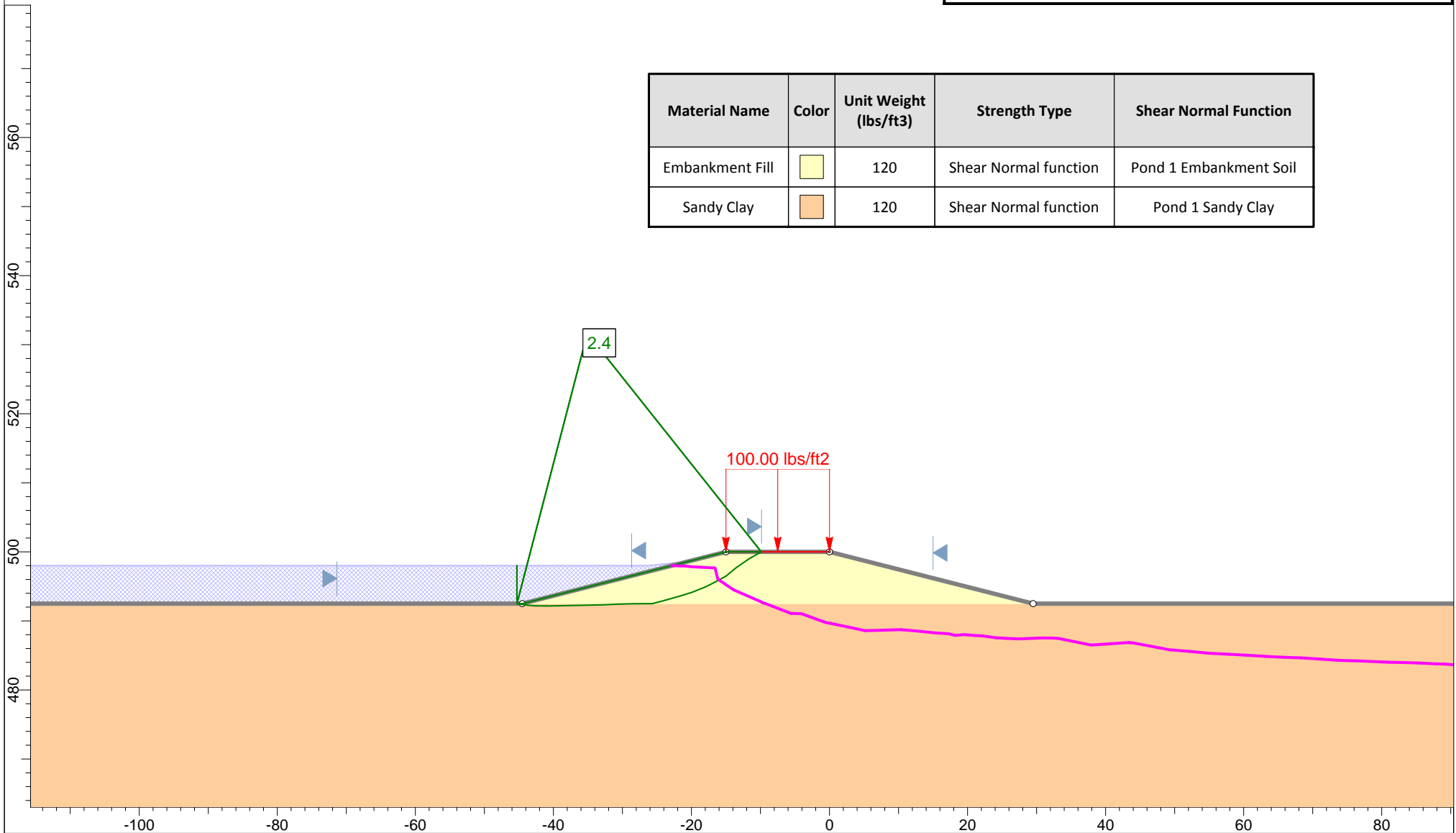



Profile "K" - Steady State
Ash Pond Berms - Spruce/Deely Generation Units

Raba Kistner Consultants, Inc.
ASA12-098-00

Figure C-12b



Global Stability Analysis

Material Name	Color	Unit Weight (lbs/ft ³)	Strength Type	Shear Normal Function
Embankment Fill		120	Shear Normal function	Pond 1 Embankment Soil
Clayey Sand		120	Shear Normal function	Pond 1 Clayey Sand
Sandy Clay		120	Shear Normal function	Pond 1 Sandy Clay

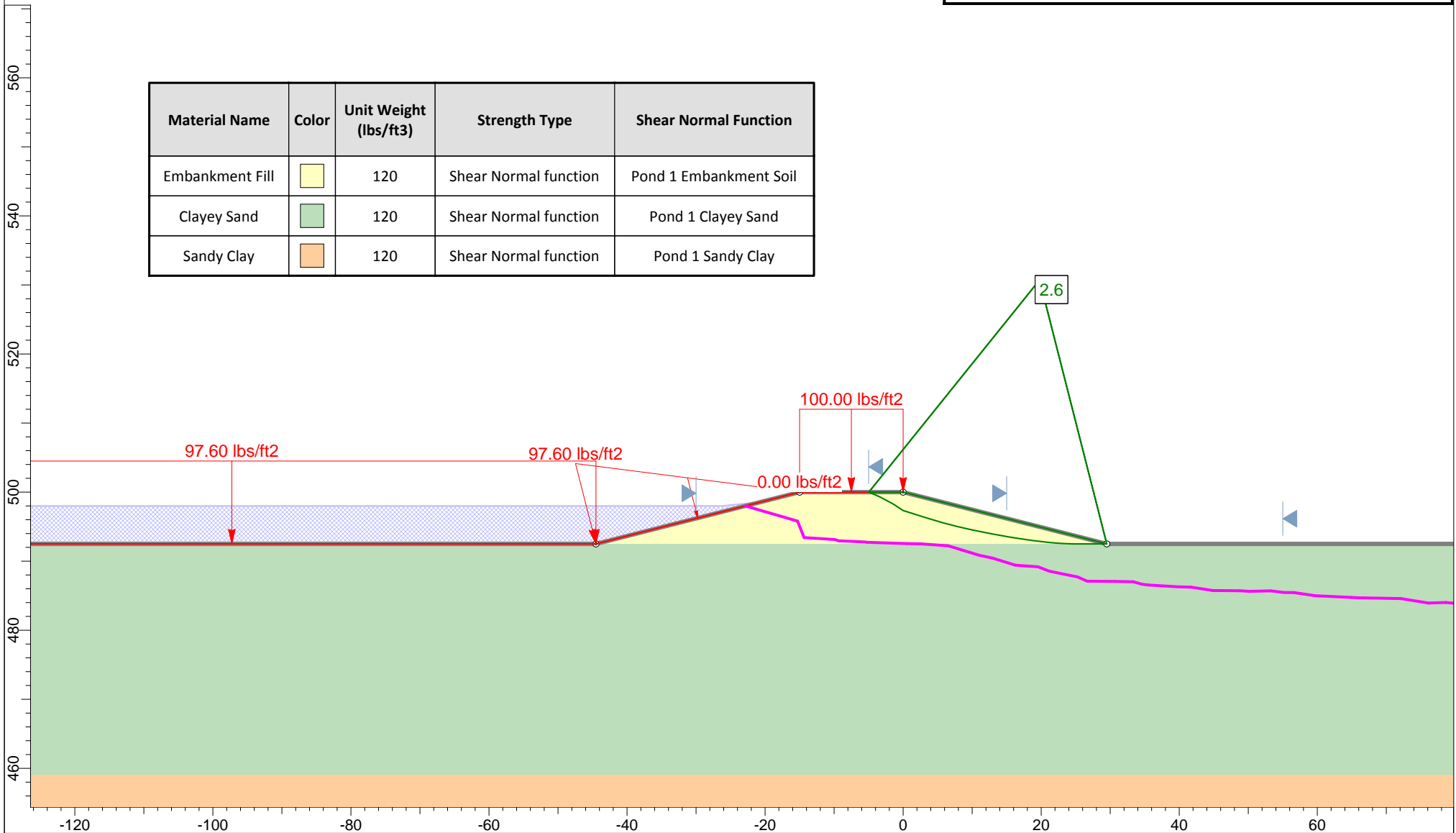



Profile "L" - Steady State
Ash Pond Berms - Spruce/Deely Generation Units

Raba Kistner Consultants, Inc.
ASA12-098-00

Figure C-13a



Global Stability Analysis

Material Name	Color	Unit Weight (lbs/ft ³)	Strength Type	Shear Normal Function
Embankment Fill		120	Shear Normal function	Pond 1 Embankment Soil
Clayey Sand		120	Shear Normal function	Pond 1 Clayey Sand
Sandy Clay		120	Shear Normal function	Pond 1 Sandy Clay

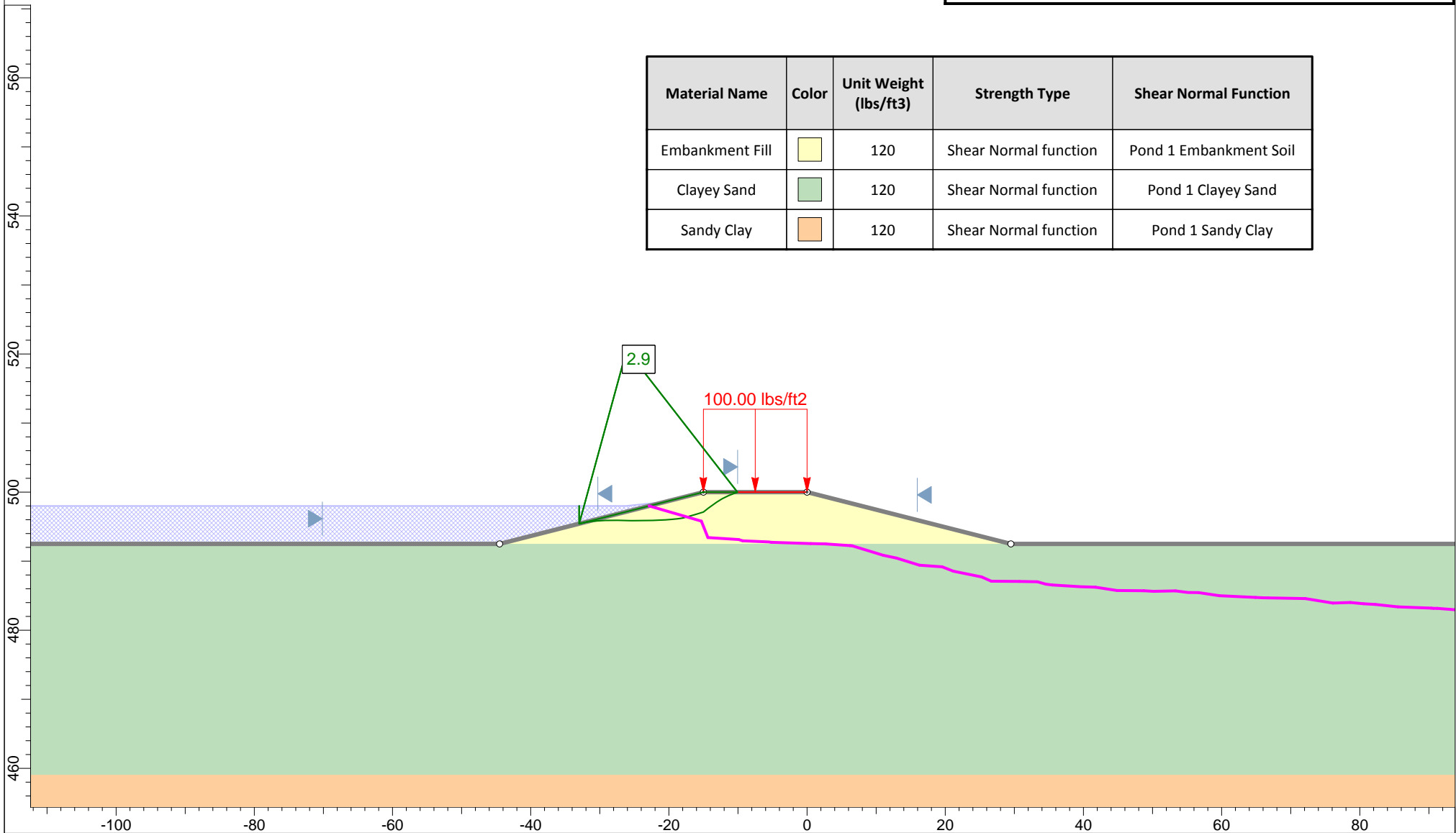



Profile "L" - Steady State
Ash Pond Berms - Spruce/Deely Generation Units

Raba Kistner Consultants, Inc.
ASA12-098-00

Figure C-13b



Global Stability Analysis

Material Name	Color	Unit Weight (lbs/ft ³)	Strength Type	Shear Normal Function
Embankment Fill		120	Shear Normal function	Pond 1 Embankment Soil
Clayey Sand		120	Shear Normal function	Pond 1 Clayey Sand
Sandy Clay		120	Shear Normal function	Pond 1 Sandy Clay

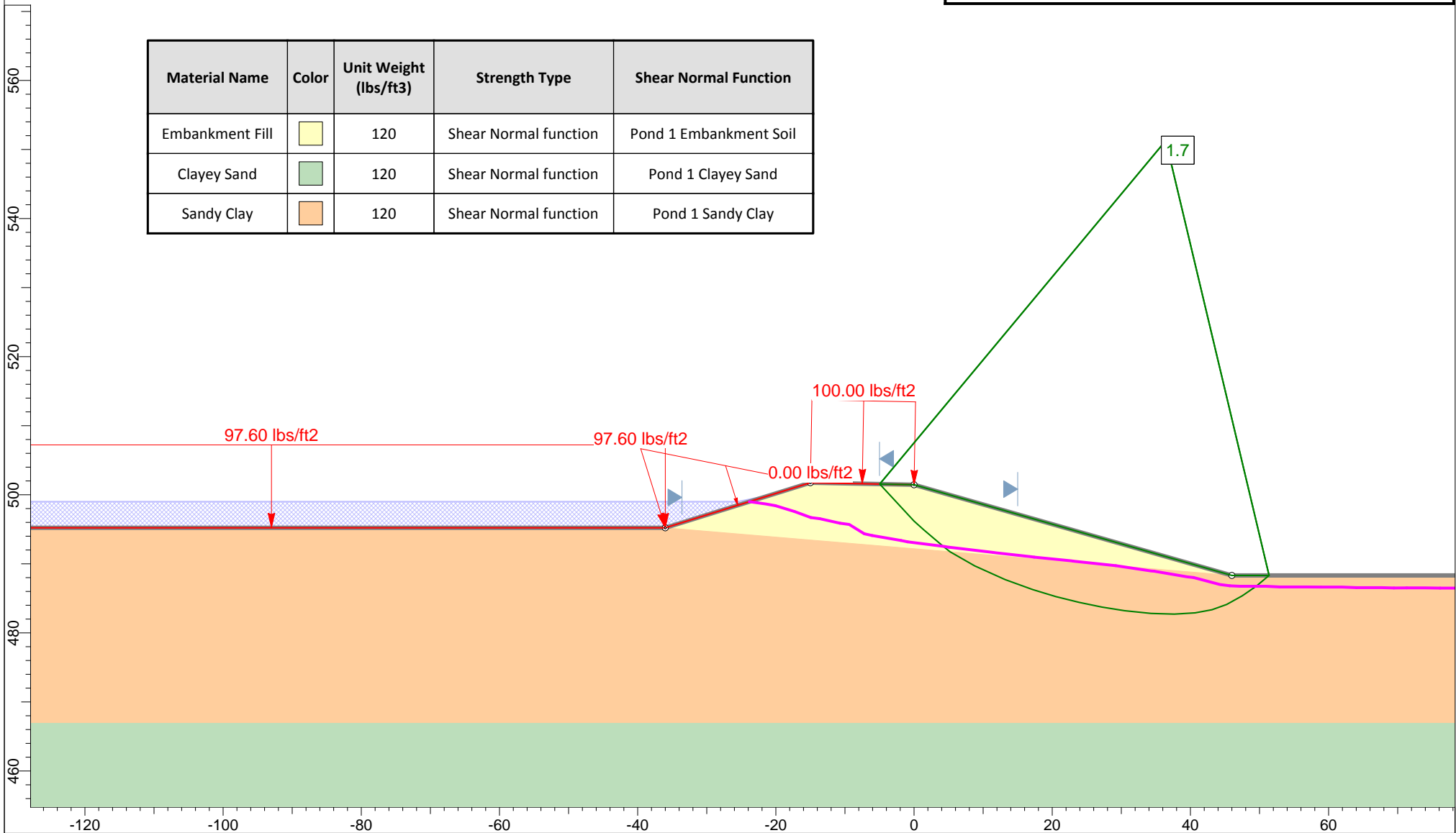

Profile "M" - Steady State
Ash Pond Berms - Spruce/Deely Generation Units

Raba Kistner Consultants, Inc.
ASA12-098-00

Figure C-14a



Global Stability Analysis

Material Name	Color	Unit Weight (lbs/ft3)	Strength Type	Shear Normal Function
Embankment Fill	Yellow	120	Shear Normal function	Pond 1 Embankment Soil
Clayey Sand	Green	120	Shear Normal function	Pond 1 Clayey Sand
Sandy Clay	Orange	120	Shear Normal function	Pond 1 Sandy Clay

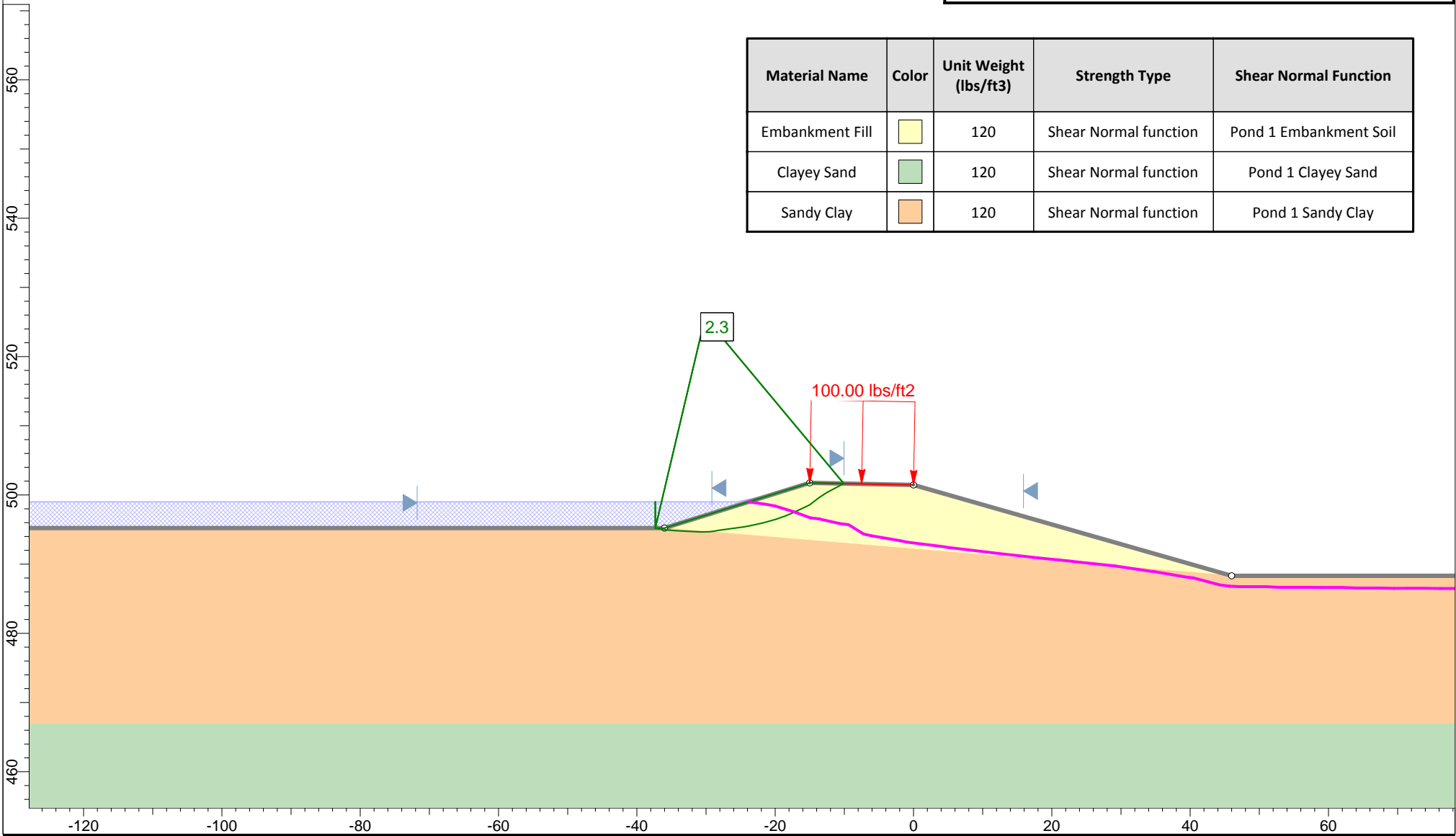



Profile "M" - Steady State
 Ash Pond Berms - Spruce/Deely Generation Units

Raba Kistner Consultants, Inc.
 ASA12-098-00

Figure C-14b

Global Stability Analysis

Material Name	Color	Unit Weight (lbs/ft ³)	Strength Type	Shear Normal Function
Embankment Fill		120	Shear Normal function	Pond 2 Embankment Soil
Clayey Sand		120	Shear Normal function	Pond 2 Clayey Sand

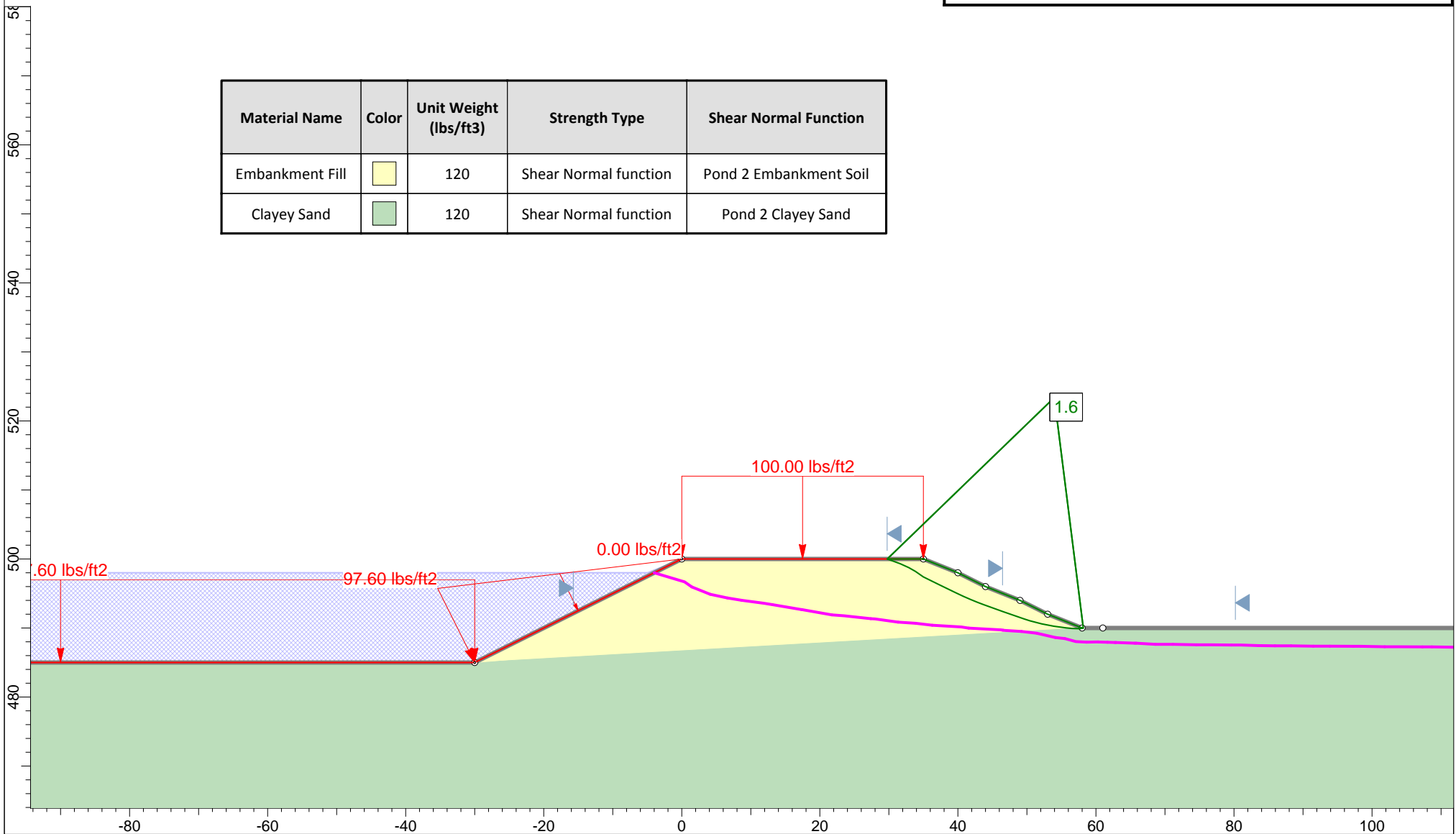



Profile "N" - Steady State
Ash Pond Berms - Spruce/Deely Generation Units

Raba Kistner Consultants, Inc.
ASA12-098-00

Figure C-15a



Global Stability Analysis

Material Name	Color	Unit Weight (lbs/ft ³)	Strength Type	Shear Normal Function
Embankment Fill		120	Shear Normal function	Pond 2 Embankment Soil
Clayey Sand		120	Shear Normal function	Pond 2 Clayey Sand

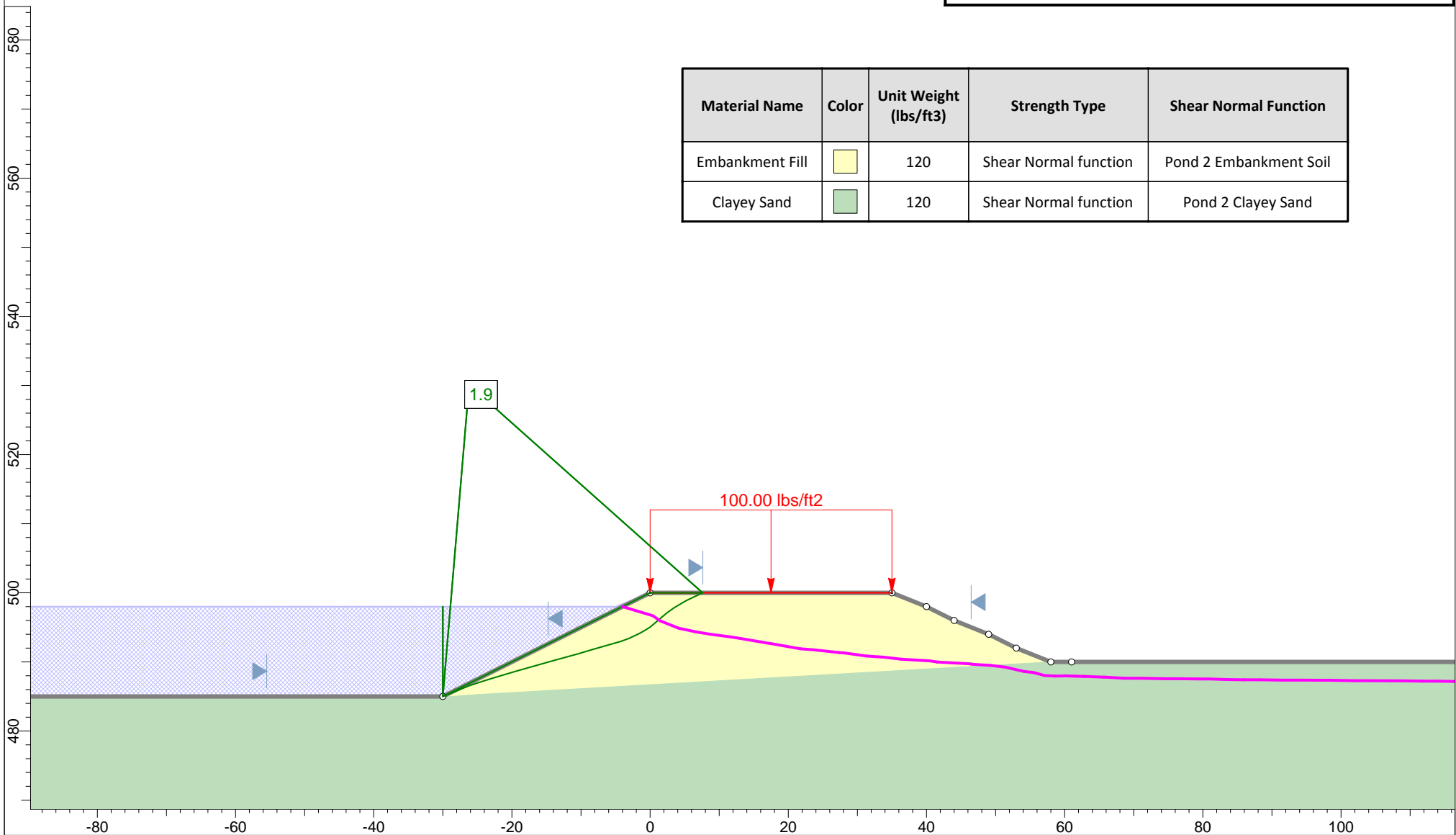



Profile "N" - Steady State
Ash Pond Berms - Spruce/Deely Generation Units

Raba Kistner Consultants, Inc.
ASA12-098-00

Figure C-15b



Global Stability Analysis

Material Name	Color	Unit Weight (lbs/ft ³)	Strength Type	Shear Normal Function
Embankment Fill		120	Shear Normal function	Pond 3 Embankment Soil
Clayey Sand		120	Shear Normal function	Pond 3 Clayey Sand

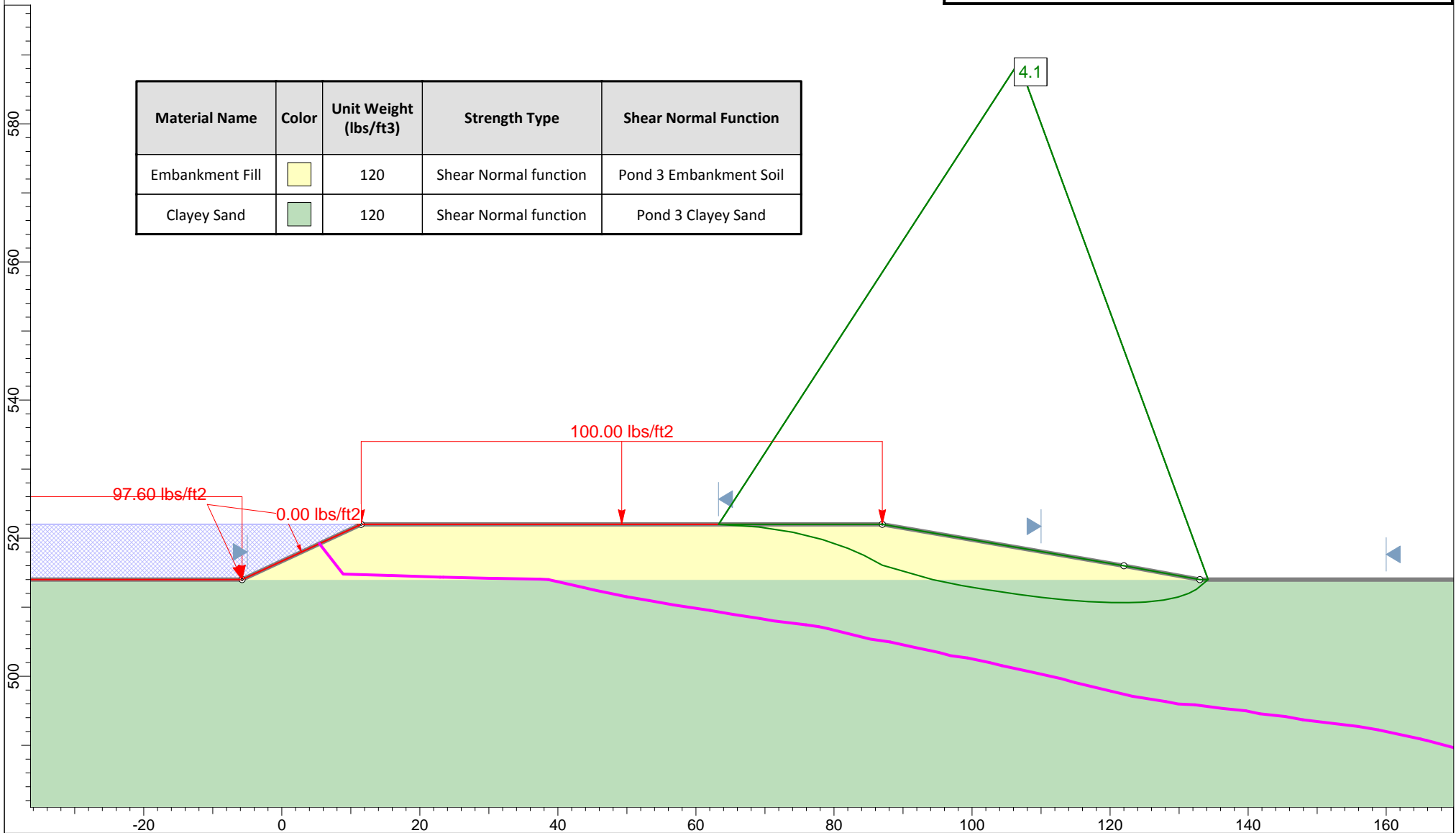



Profile "A" - Maximum Pool
Ash Pond Berms - Spruce/Deely Generation Units

Raba Kistner Consultants, Inc.
ASA12-098-00

Figure C-16a



Global Stability Analysis

Material Name	Color	Unit Weight (lbs/ft3)	Strength Type	Shear Normal Function
Embankment Fill		120	Shear Normal function	Pond 3 Embankment Soil
Clayey Sand		120	Shear Normal function	Pond 3 Clayey Sand

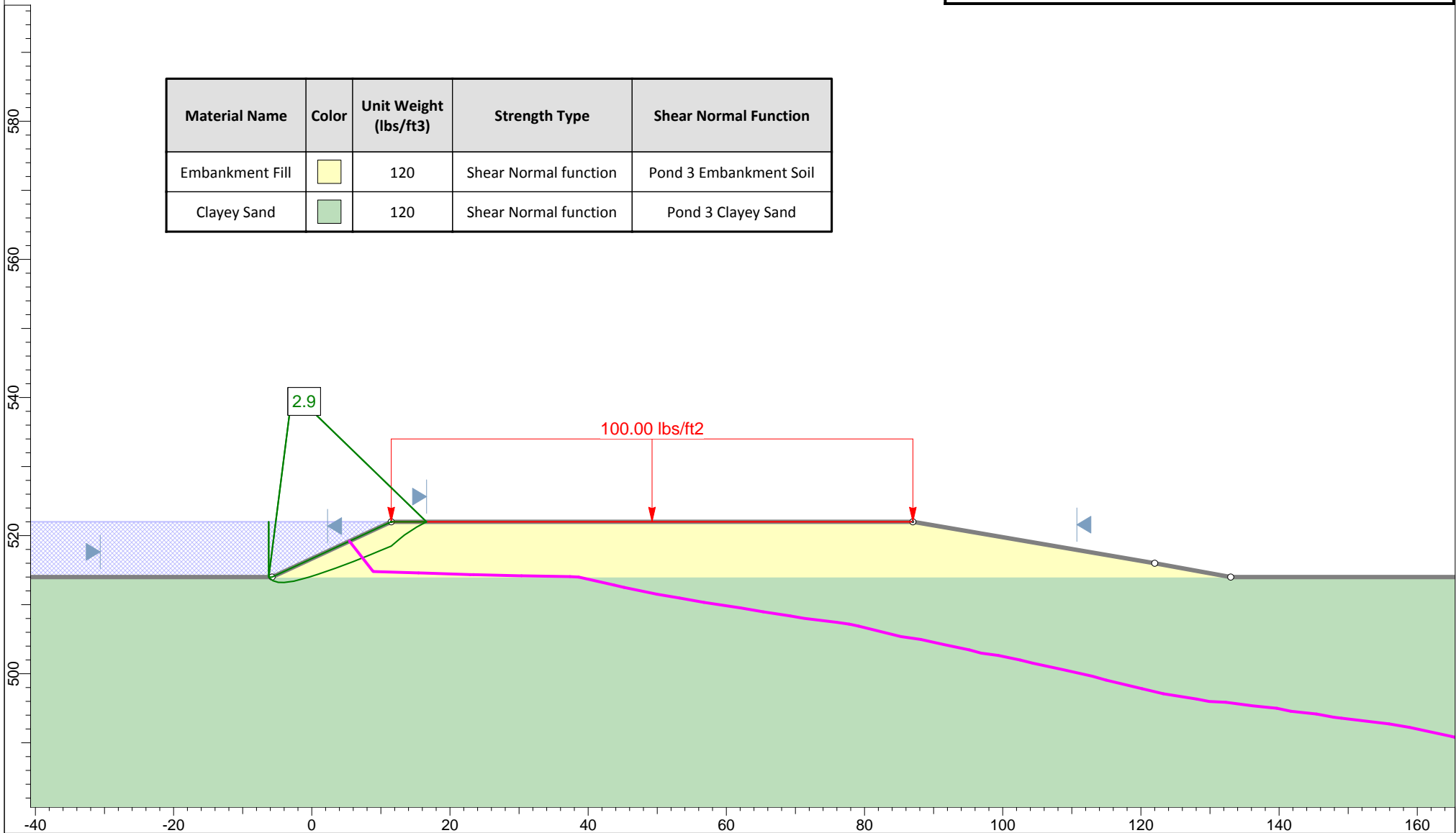



Profile "A" - Maximum Pool
Ash Pond Berms - Spruce/Deely Generation Units

Raba Kistner Consultants, Inc.
ASA12-098-00

Figure C-16b



Global Stability Analysis

Material Name	Color	Unit Weight (lbs/ft ³)	Strength Type	Shear Normal Function
Embankment Fill		120	Shear Normal function	Pond 3 Embankment Soil
Clayey Sand		120	Shear Normal function	Pond 3 Clayey Sand
Sandy Clay		120	Shear Normal function	Pond 3 Sandy Clay

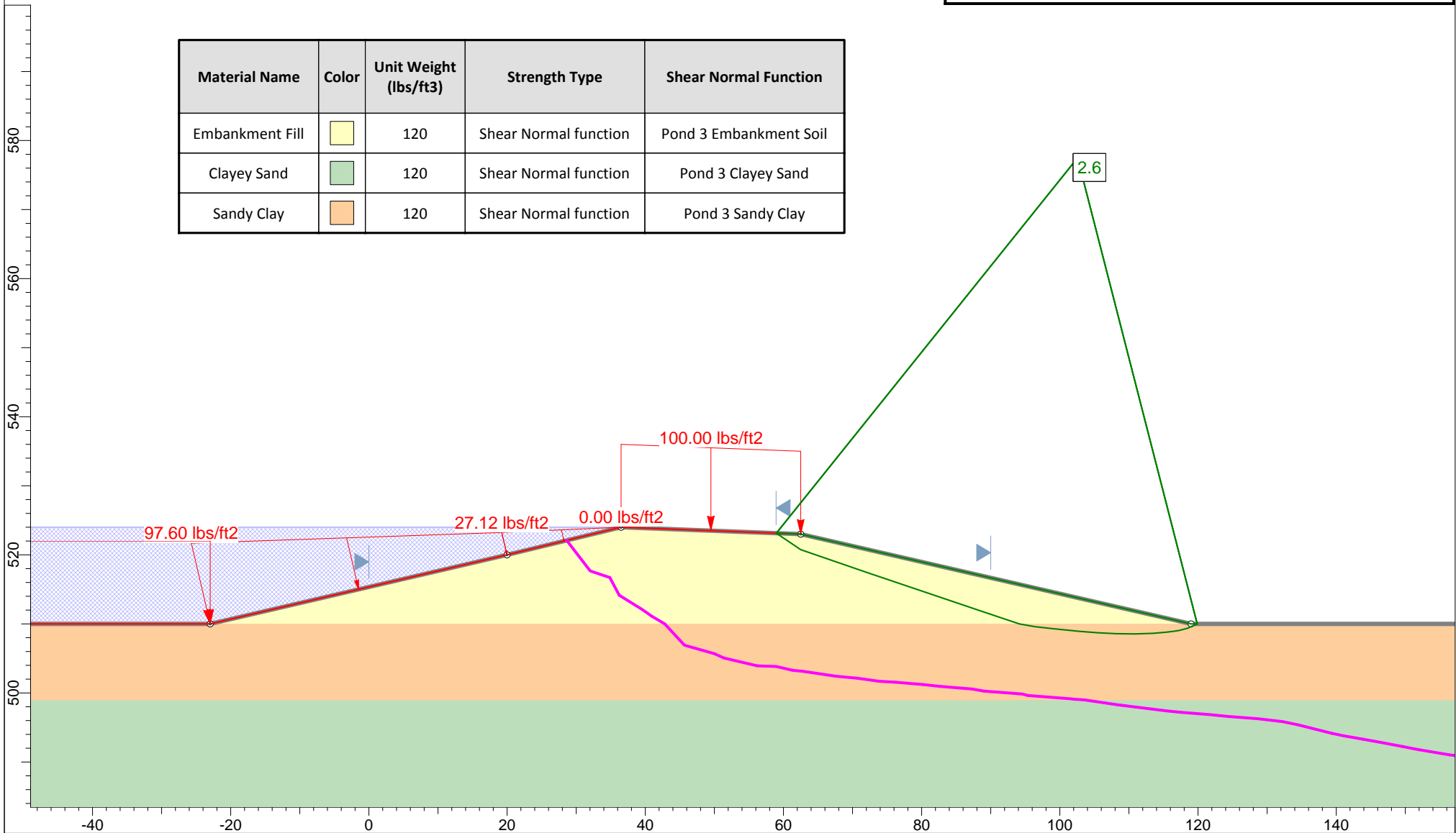



Profile "B" - Maximum Pool
Ash Pond Berms - Spruce/Deely Generation Units

Raba Kistner Consultants, Inc.
ASA12-098-00

Figure C-17a



Global Stability Analysis

Material Name	Color	Unit Weight (lbs/ft ³)	Strength Type	Shear Normal Function
Embankment Fill		120	Shear Normal function	Pond 3 Embankment Soil
Clayey Sand		120	Shear Normal function	Pond 3 Clayey Sand
Sandy Clay		120	Shear Normal function	Pond 3 Sandy Clay

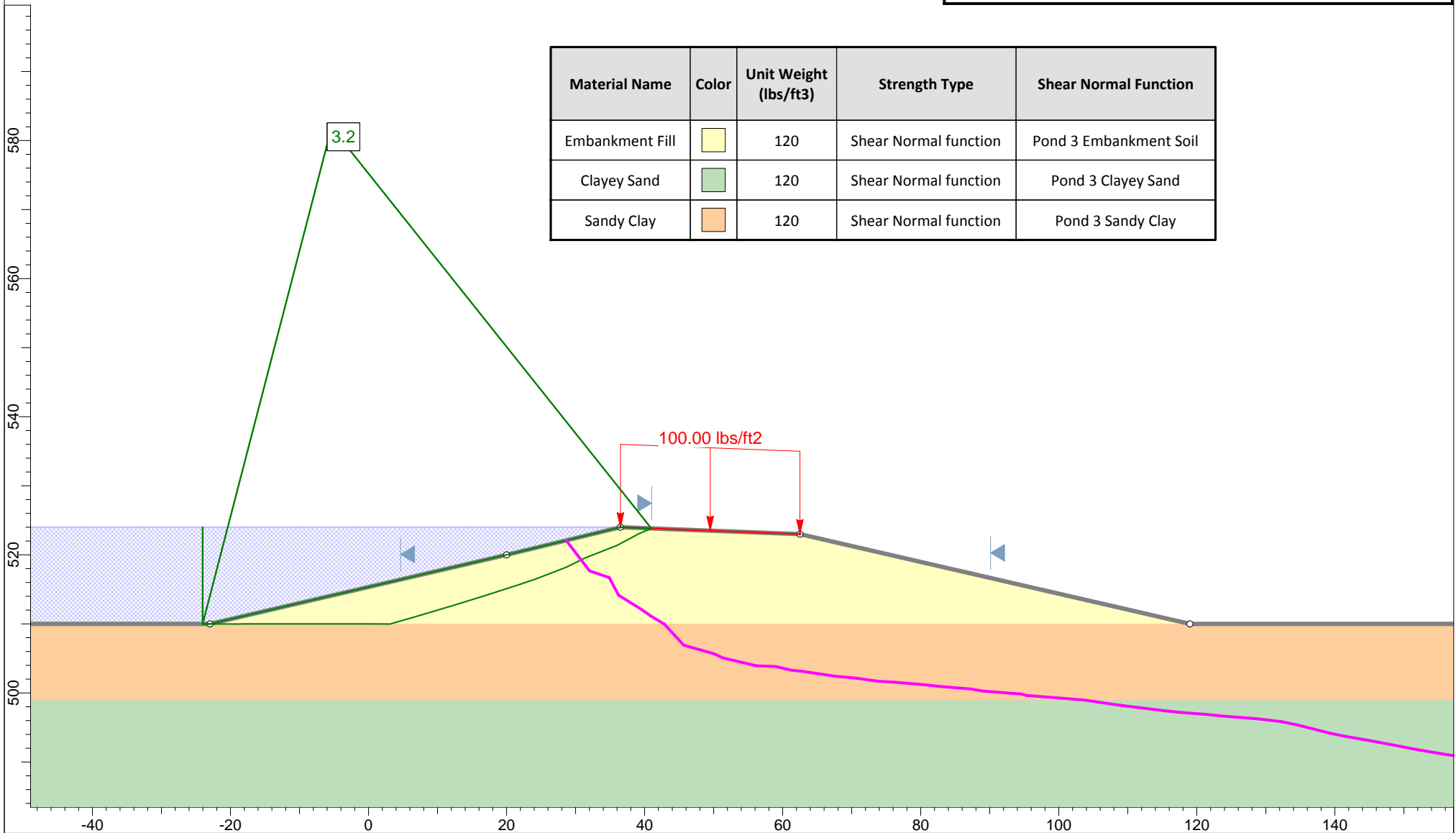

Profile "B" - Maximum Pool
Ash Pond Berms - Spruce/Deely Generation Units

Raba Kistner Consultants, Inc.
ASA12-098-00

Figure C-17b



Global Stability Analysis

Material Name	Color	Unit Weight (lbs/ft ³)	Strength Type	Shear Normal Function
Embankment Fill	Yellow	120	Shear Normal function	Pond 3 Embankment Soil
Clayey Sand	Green	120	Shear Normal function	Pond 3 Clayey Sand

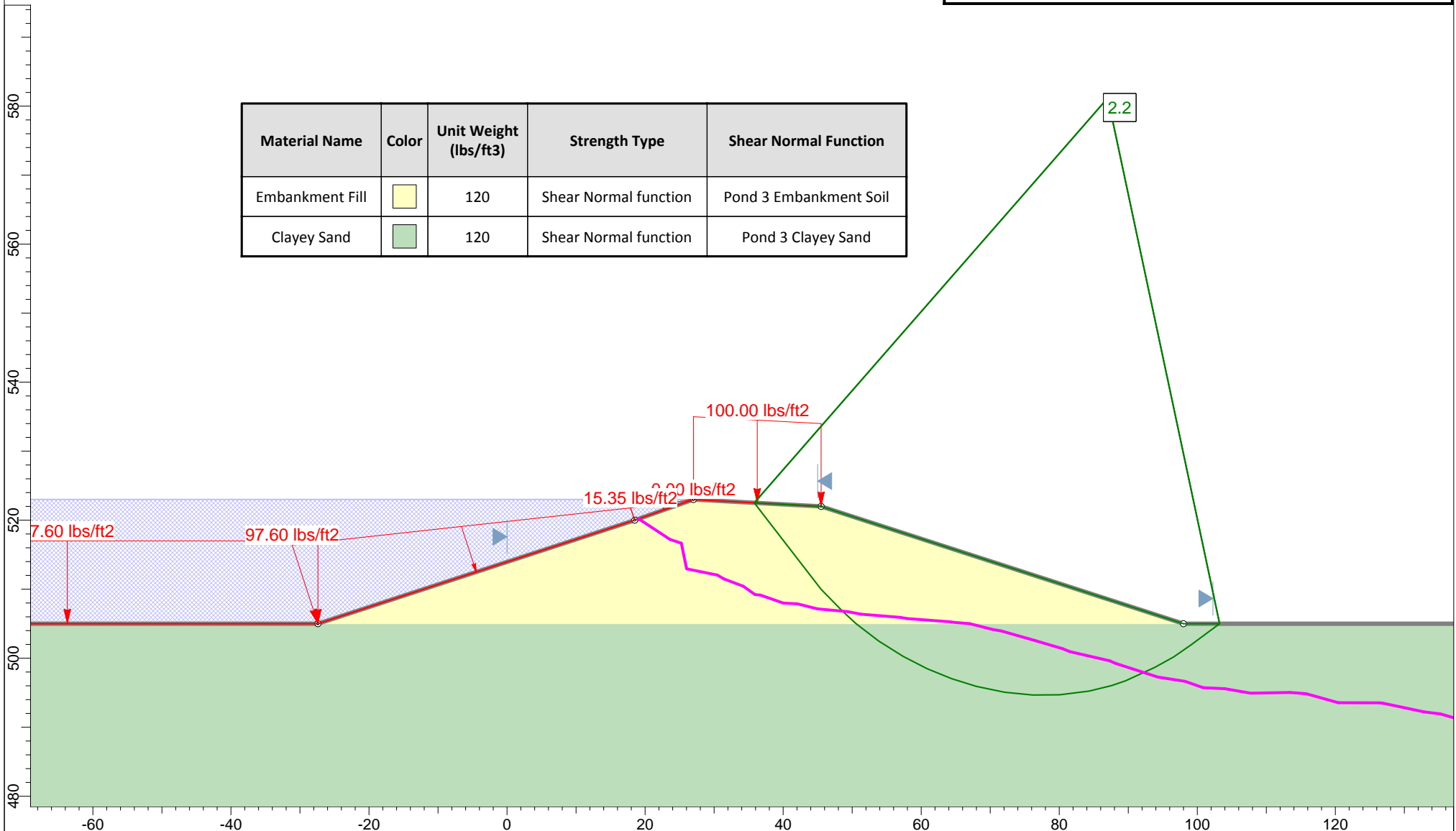

Profile "C" - Maximum Pool
Ash Pond Berms - Spruce/Deely Generation Units

Raba Kistner Consultants, Inc.
ASA12-098-00

Figure C-18a



Global Stability Analysis

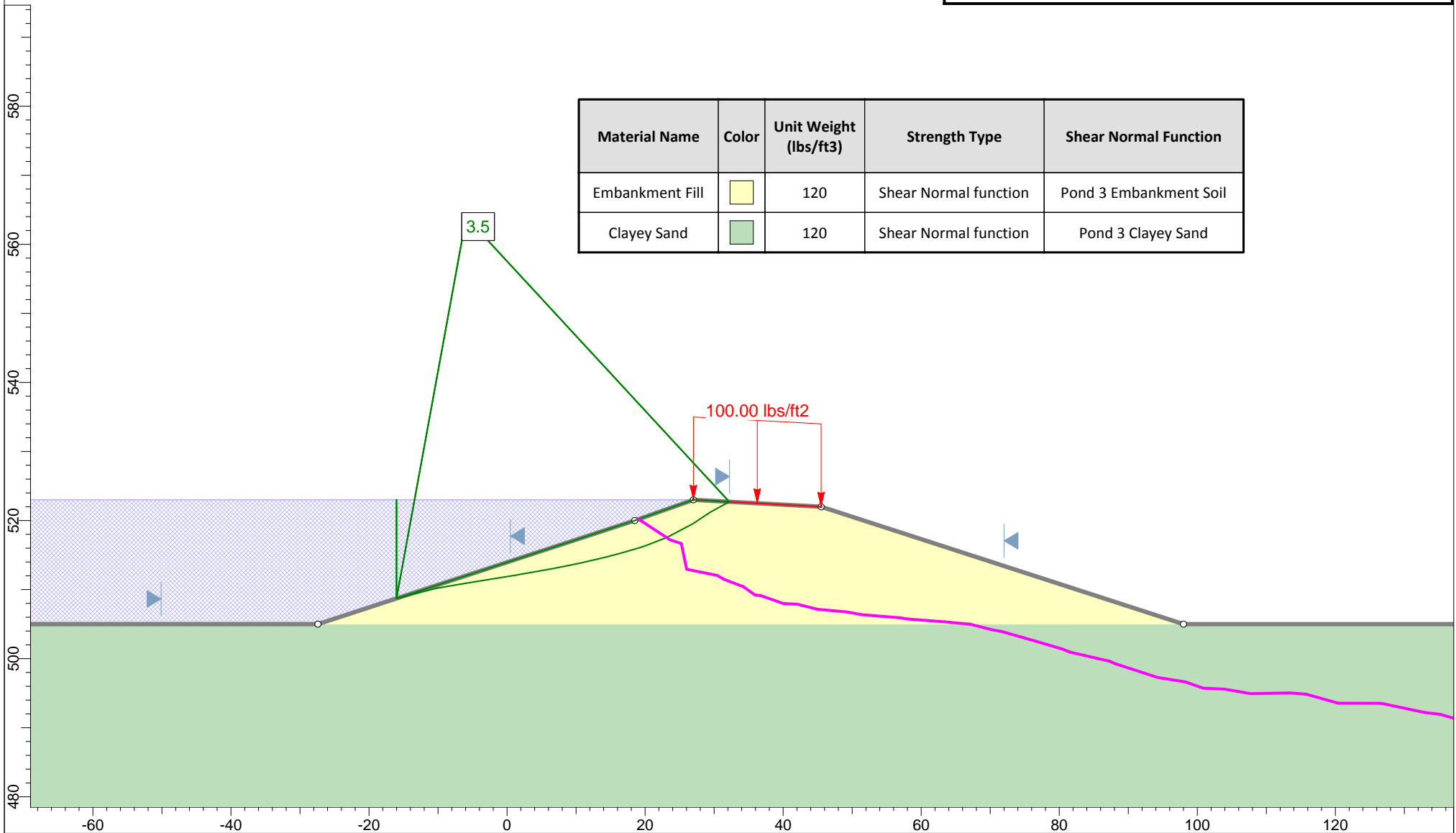



Profile "C" - Maximum Pool
Ash Pond Berms - Spruce/Deely Generation Units

Raba Kistner Consultants, Inc.
ASA12-098-00

Figure C-18b



Global Stability Analysis

Material Name	Color	Unit Weight (lbs/ft ³)	Strength Type	Shear Normal Function
Embankment Fill		120	Shear Normal function	Pond 3 Embankment Soil
Clayey Sand		120	Shear Normal function	Pond 3 Clayey Sand
Sandy Clay		120	Shear Normal function	Pond 3 Sandy Clay

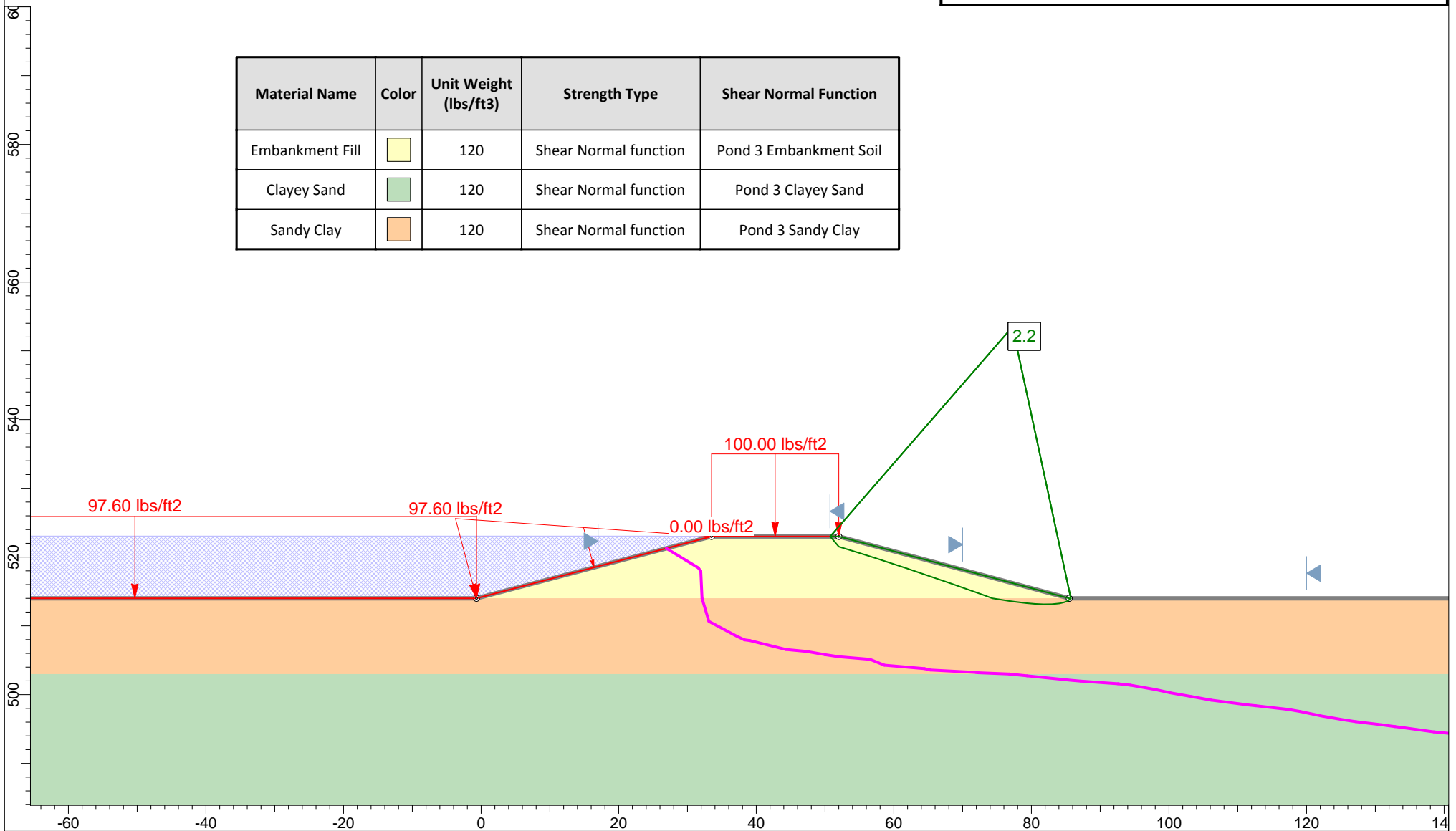



Profile "D" - Maximum Pool
Ash Pond Berms - Spruce/Deely Generation Units

Raba Kistner Consultants, Inc.
ASA12-098-00

Figure C-19a



Global Stability Analysis

Material Name	Color	Unit Weight (lbs/ft ³)	Strength Type	Shear Normal Function
Embankment Fill		120	Shear Normal function	Pond 3 Embankment Soil
Clayey Sand		120	Shear Normal function	Pond 3 Clayey Sand
Sandy Clay		120	Shear Normal function	Pond 3 Sandy Clay

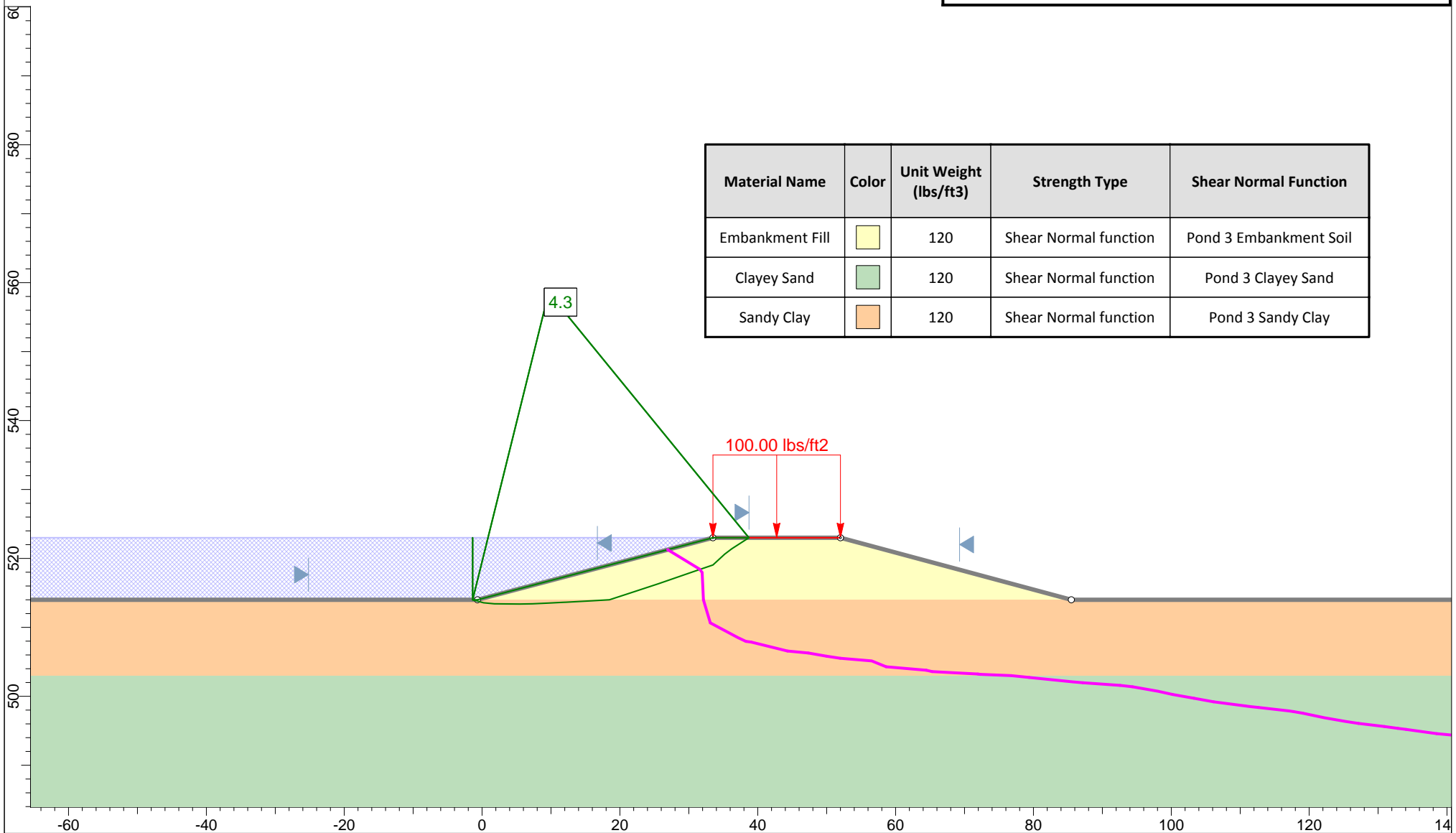



Profile "D" - Maximum Pool
Ash Pond Berms - Spruce/Deely Generation Units

Raba Kistner Consultants, Inc.
ASA12-098-00

Figure C-19b



Global Stability Analysis

Material Name	Color	Unit Weight (lbs/ft ³)	Strength Type	Shear Normal Function
Embankment Soil		120	Shear Normal function	Pond 2 Embankment Soil
Clayey Sand		120	Shear Normal function	Pond 2 Clayey Sand
Sandy Clay		120	Shear Normal function	Pond 2 Sandy Clay

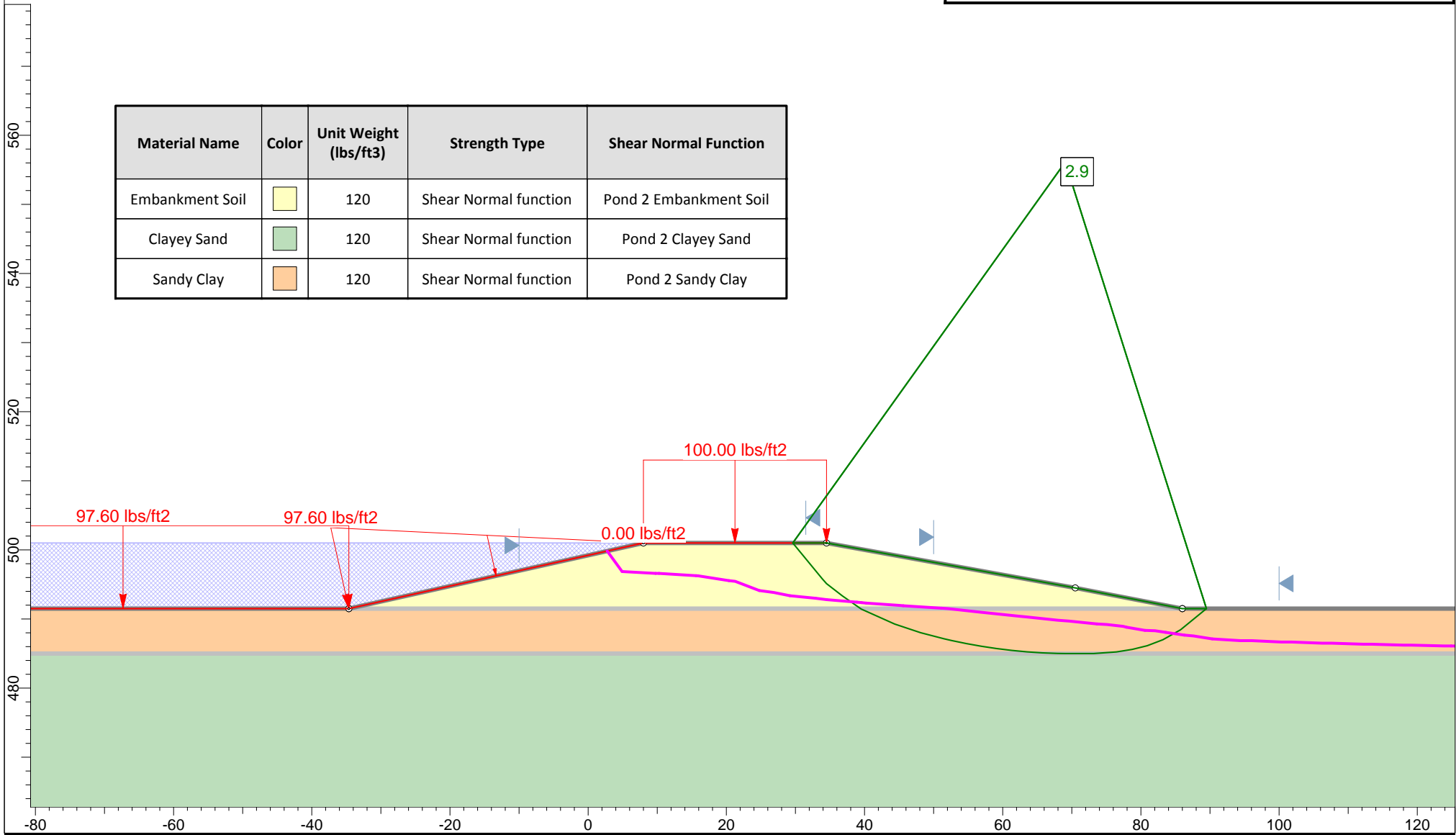

Profile "E" - Maximum Pool
Ash Pond Berms - Spruce/Deely Generation Units

Raba Kistner Consultants, Inc.
ASA12-098-00

Figure C-20a



Global Stability Analysis

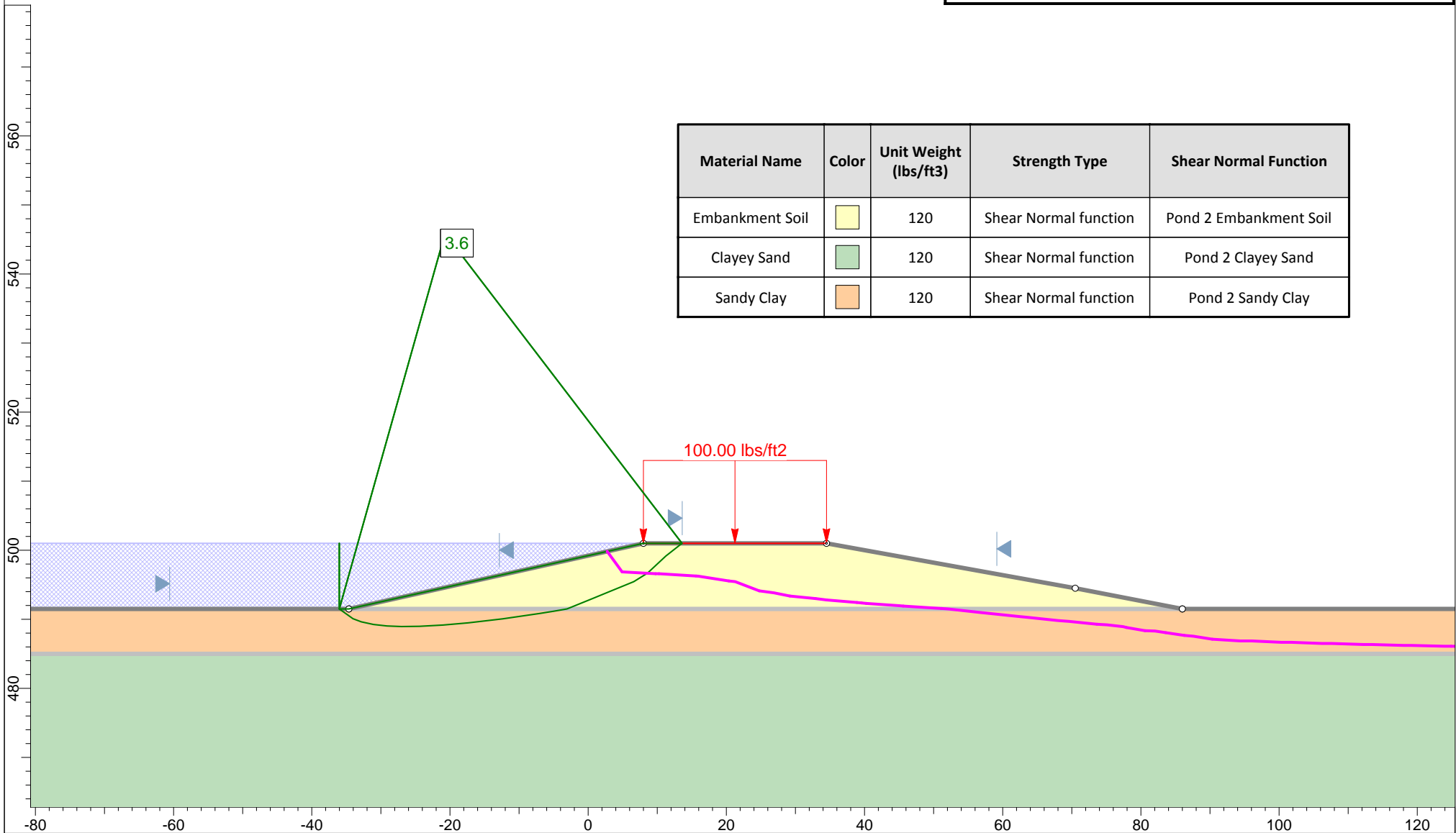

Material Name	Color	Unit Weight (lbs/ft ³)	Strength Type	Shear Normal Function
Embankment Soil		120	Shear Normal function	Pond 2 Embankment Soil
Clayey Sand		120	Shear Normal function	Pond 2 Clayey Sand
Sandy Clay		120	Shear Normal function	Pond 2 Sandy Clay



Profile "E" - Maximum Pool
Ash Pond Berms - Spruce/Deely Generation Units

Raba Kistner Consultants, Inc.
ASA12-098-00

Figure C-20b



Global Stability Analysis

Material Name	Color	Unit Weight (lbs/ft ³)	Strength Type	Shear Normal Function
Embankment Fill		120	Shear Normal function	Pond 2 Embankment Soil
Clayey Sand		120	Shear Normal function	Pond 2 Clayey Sand
Sandy Clay		120	Shear Normal function	Pond 2 Sandy Clay

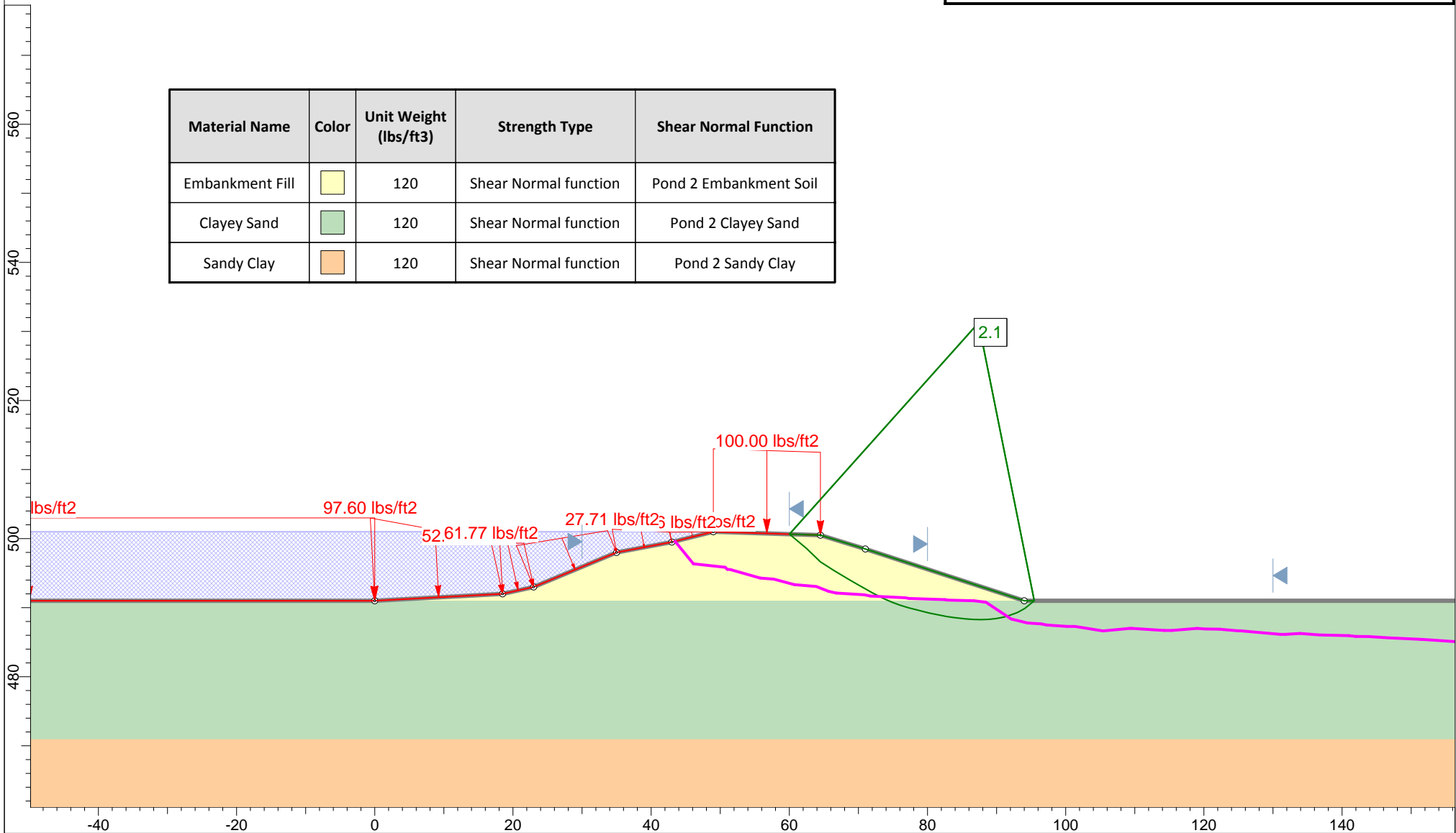



Profile "F" - Maximum Pool
Ash Pond Berms - Spruce/Deely Generation Units

Raba Kistner Consultants, Inc.
ASA12-098-00

Figure C-21a



Global Stability Analysis

Material Name	Color	Unit Weight (lbs/ft ³)	Strength Type	Shear Normal Function
Embankment Fill		120	Shear Normal function	Pond 2 Embankment Soil
Clayey Sand		120	Shear Normal function	Pond 2 Clayey Sand
Sandy Clay		120	Shear Normal function	Pond 2 Sandy Clay

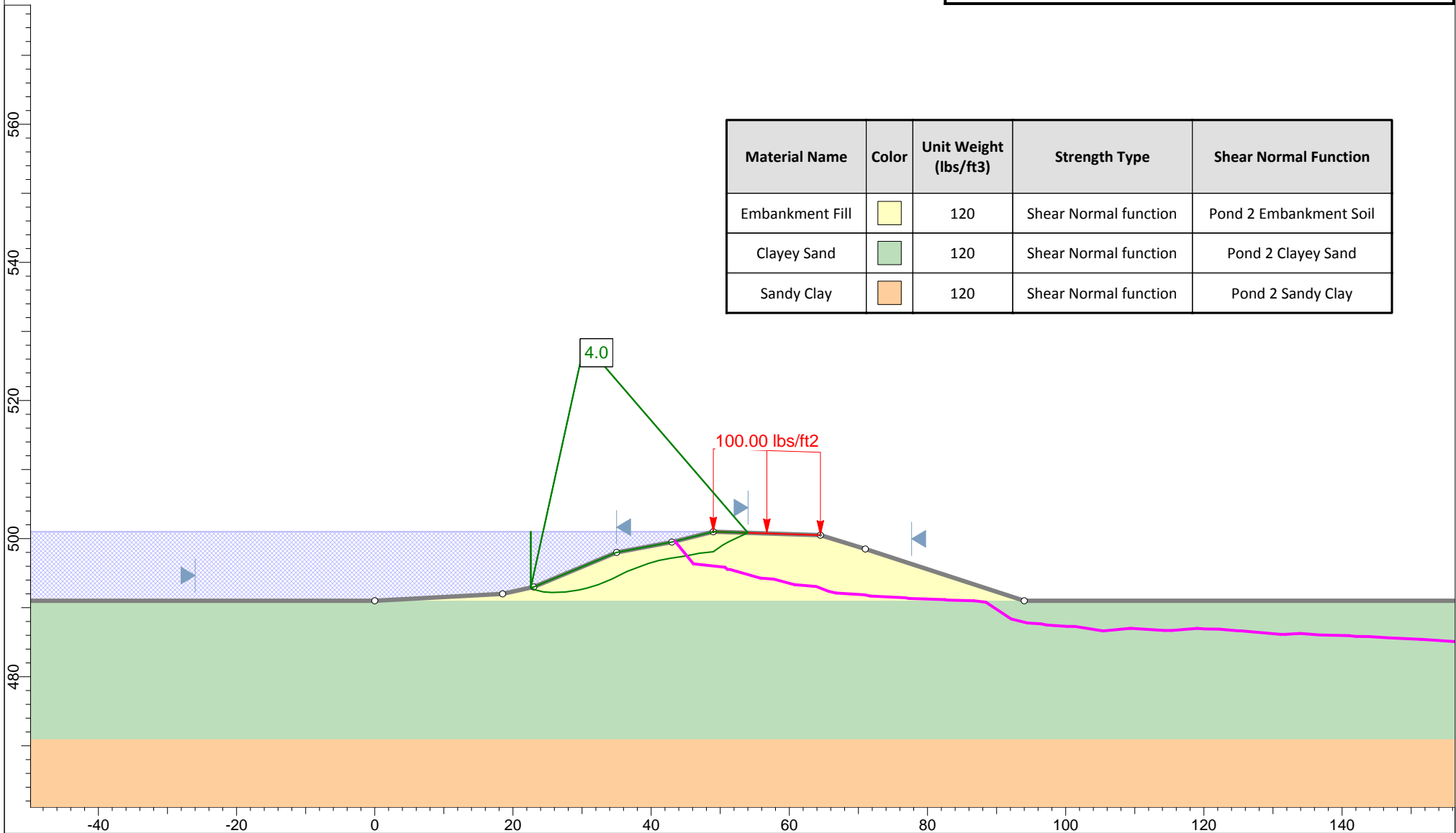



Profile "F" - Maximum Pool
Ash Pond Berms - Spruce/Deely Generation Units

Raba Kistner Consultants, Inc.
ASA12-098-00

Figure C-21b



Global Stability Analysis

Material Name	Color	Unit Weight (lbs/ft ³)	Strength Type	Shear Normal Function
Embankment Fill		120	Shear Normal function	Pond 2 Embankment Soil
Clayey Sand		120	Shear Normal function	Pond 2 Clayey Sand
Sandy Clay		120	Shear Normal function	Pond 2 Sandy Clay

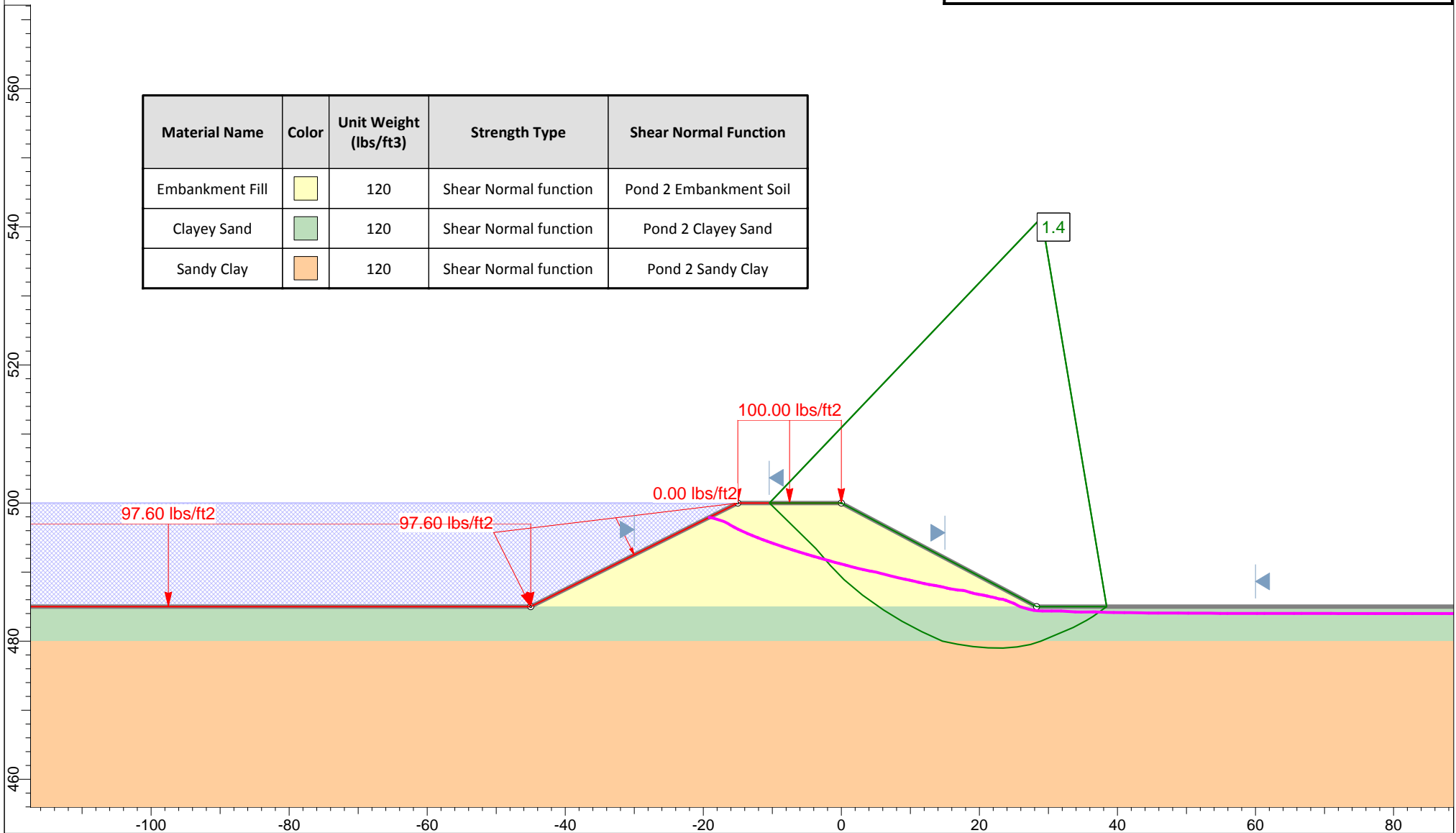



Profile "G" - Maximum Pool
Ash Pond Berms - Spruce/Deely Generation Units

Raba Kistner Consultants, Inc.
ASA12-098-00

Figure C-22a



Global Stability Analysis

Material Name	Color	Unit Weight (lbs/ft ³)	Strength Type	Shear Normal Function
Embankment Fill		120	Shear Normal function	Pond 2 Embankment Soil
Clayey Sand		120	Shear Normal function	Pond 2 Clayey Sand
Sandy Clay		120	Shear Normal function	Pond 2 Sandy Clay

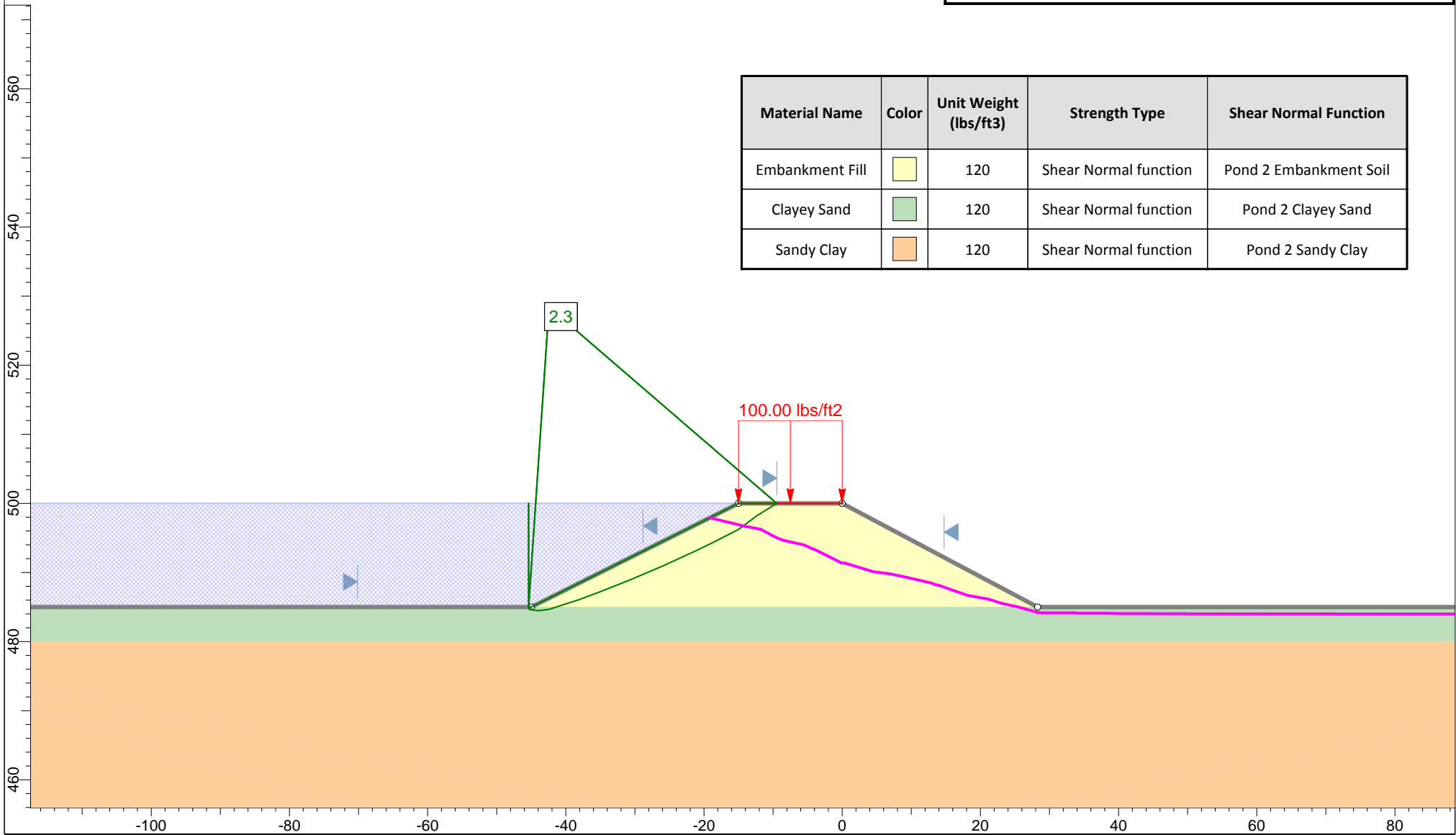



Profile "G" - Maximum Pool
Ash Pond Berms - Spruce/Deely Generation Units

Raba Kistner Consultants, Inc.
ASA12-098-00

Figure C-22b



Global Stability Analysis

Material Name	Color	Unit Weight (lbs/ft ³)	Strength Type	Shear Normal Function
Embankment Fill		120	Shear Normal function	Pond 2 Embankment Soil
Clayey Sand		120	Shear Normal function	Pond 2 Clayey Sand
Sandy Clay		120	Shear Normal function	Pond 2 Sandy Clay

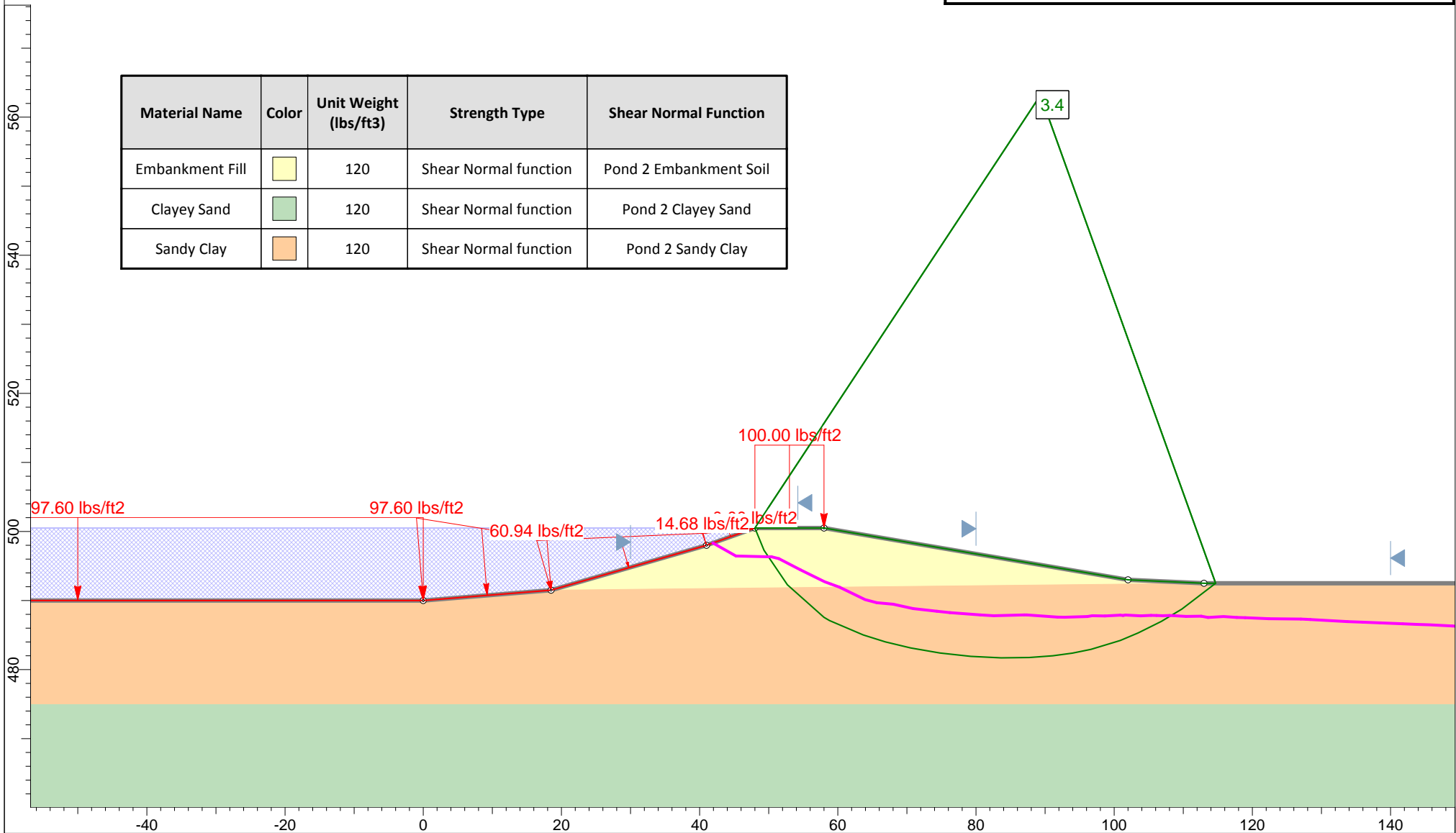



Profile "H" - Maximum Pool
Ash Pond Berms - Spruce/Deely Generation Units

Raba Kistner Consultants, Inc.
ASA12-098-00

Figure C-23a



Global Stability Analysis

Material Name	Color	Unit Weight (lbs/ft ³)	Strength Type	Shear Normal Function
Embankment Fill		120	Shear Normal function	Pond 2 Embankment Soil
Clayey Sand		120	Shear Normal function	Pond 2 Clayey Sand
Sandy Clay		120	Shear Normal function	Pond 2 Sandy Clay

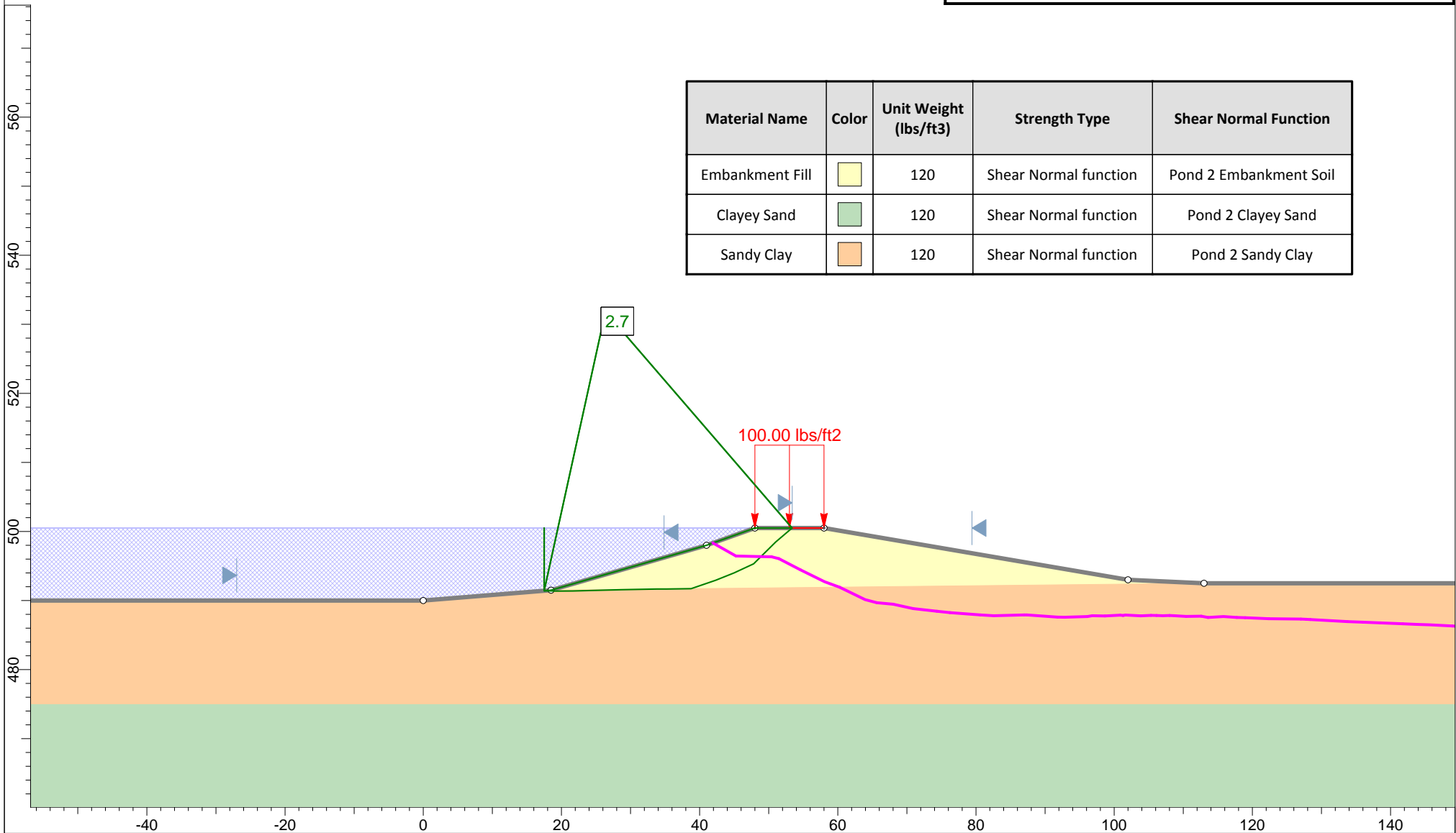



Profile "H" - Maximum Pool
Ash Pond Berms - Spruce/Deely Generation Units

Raba Kistner Consultants, Inc.
ASA12-098-00

Figure C-23b



Global Stability Analysis

Material Name	Color	Unit Weight (lbs/ft ³)	Strength Type	Shear Normal Function
Embankment Fill		120	Shear Normal function	Pond 2 Embankment Soil
Clayey Sand		120	Shear Normal function	Pond 2 Clayey Sand
Sandy Clay		120	Shear Normal function	Pond 2 Sandy Clay

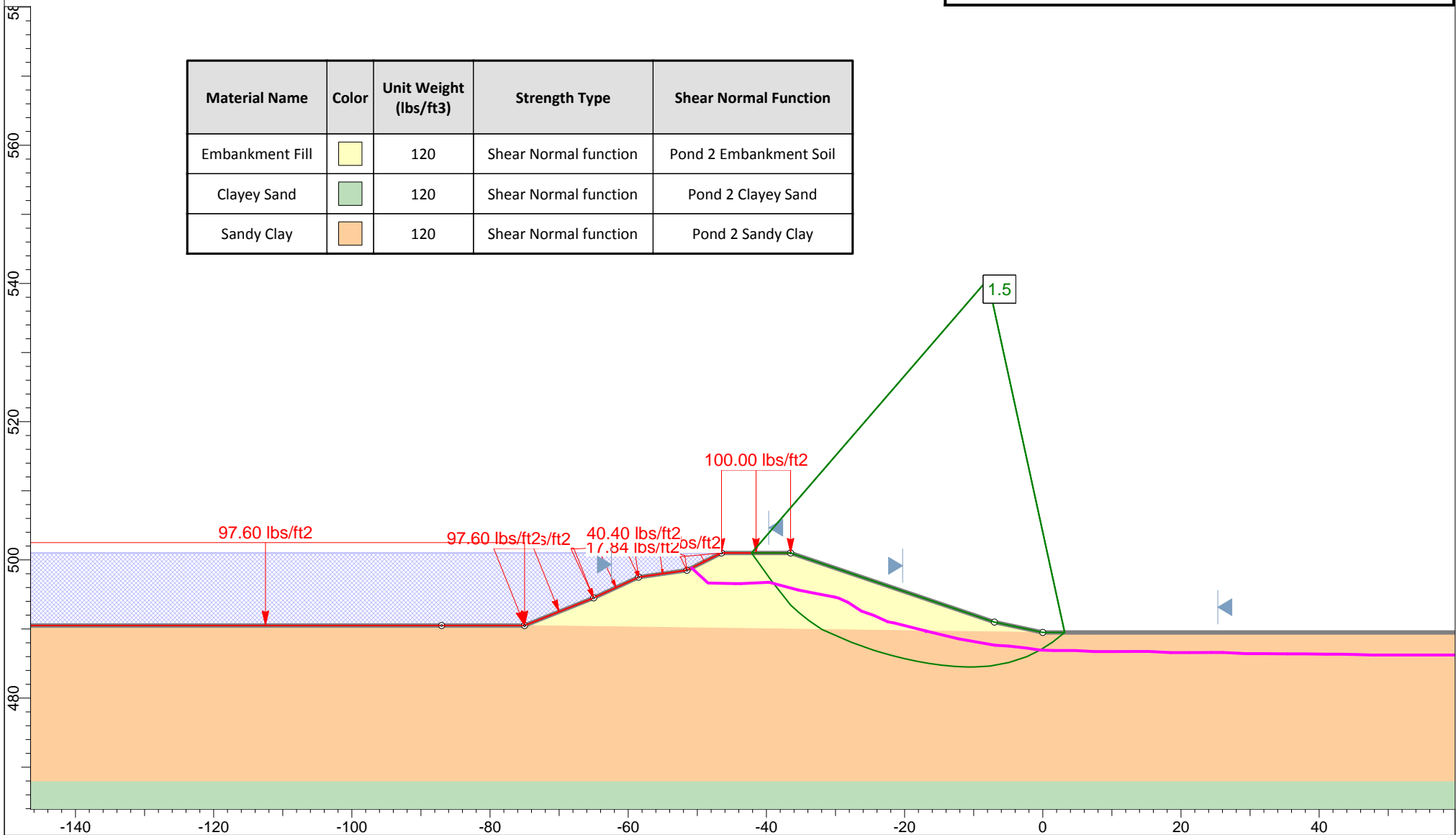



Profile "I" - Maximum Pool
Ash Pond Berms - Spruce/Deely Generation Units

Raba Kistner Consultants, Inc.
ASA12-098-00

Figure C-24a



Global Stability Analysis

Material Name	Color	Unit Weight (lbs/ft ³)	Strength Type	Shear Normal Function
Embankment Fill		120	Shear Normal function	Pond 2 Embankment Soil
Clayey Sand		120	Shear Normal function	Pond 2 Clayey Sand
Sandy Clay		120	Shear Normal function	Pond 2 Sandy Clay

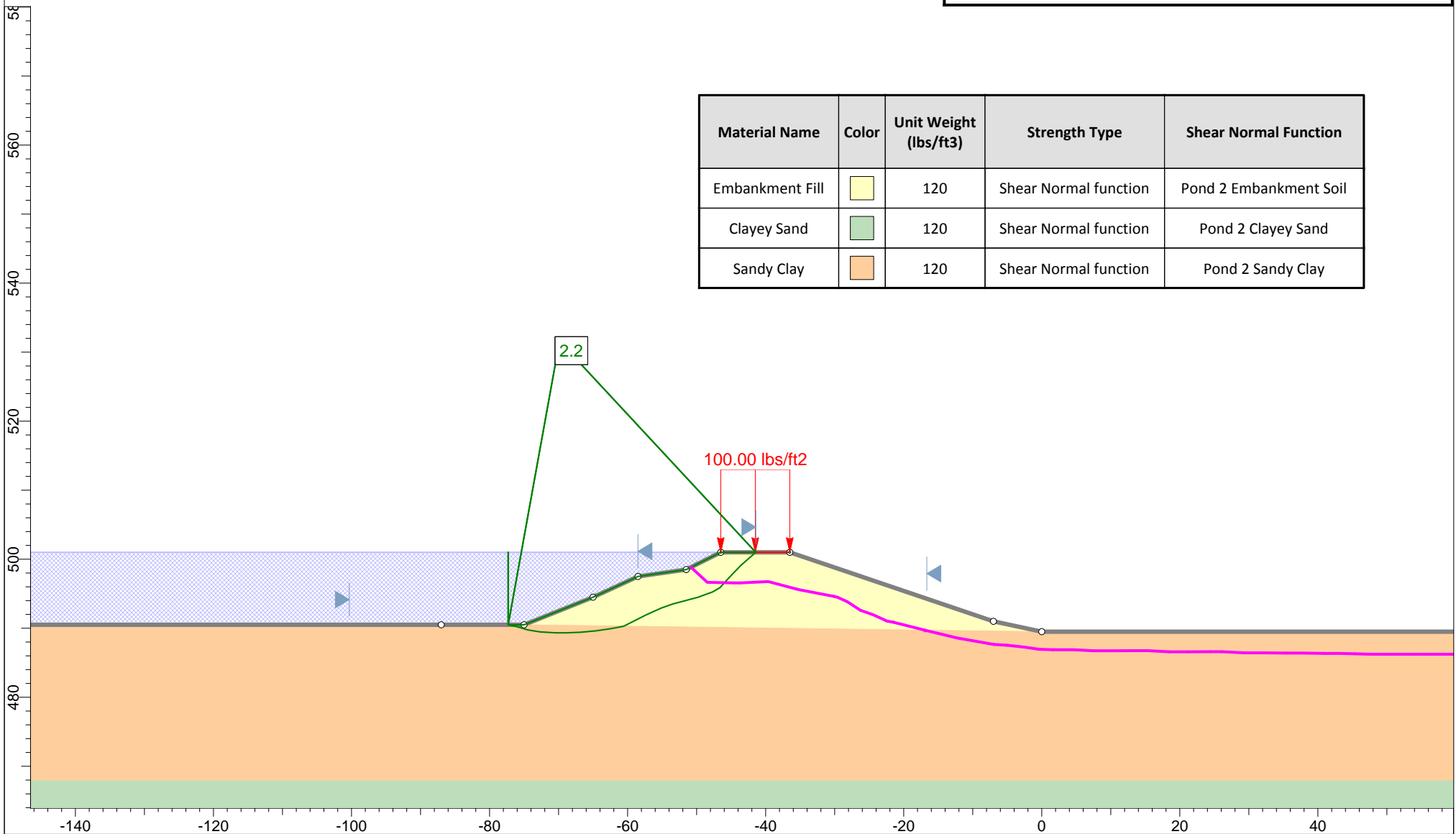



Profile "I" - Maximum Pool
Ash Pond Berms - Spruce/Deely Generation Units

Raba Kistner Consultants, Inc.
ASA12-098-00

Figure C-24b



Global Stability Analysis

Material Name	Color	Unit Weight (lbs/ft ³)	Strength Type	Shear Normal Function
Embankment Fill		120	Shear Normal function	Pond 1 Embankment Soil
Clayey Sand		120	Shear Normal function	Pond 1 Clayey Sand

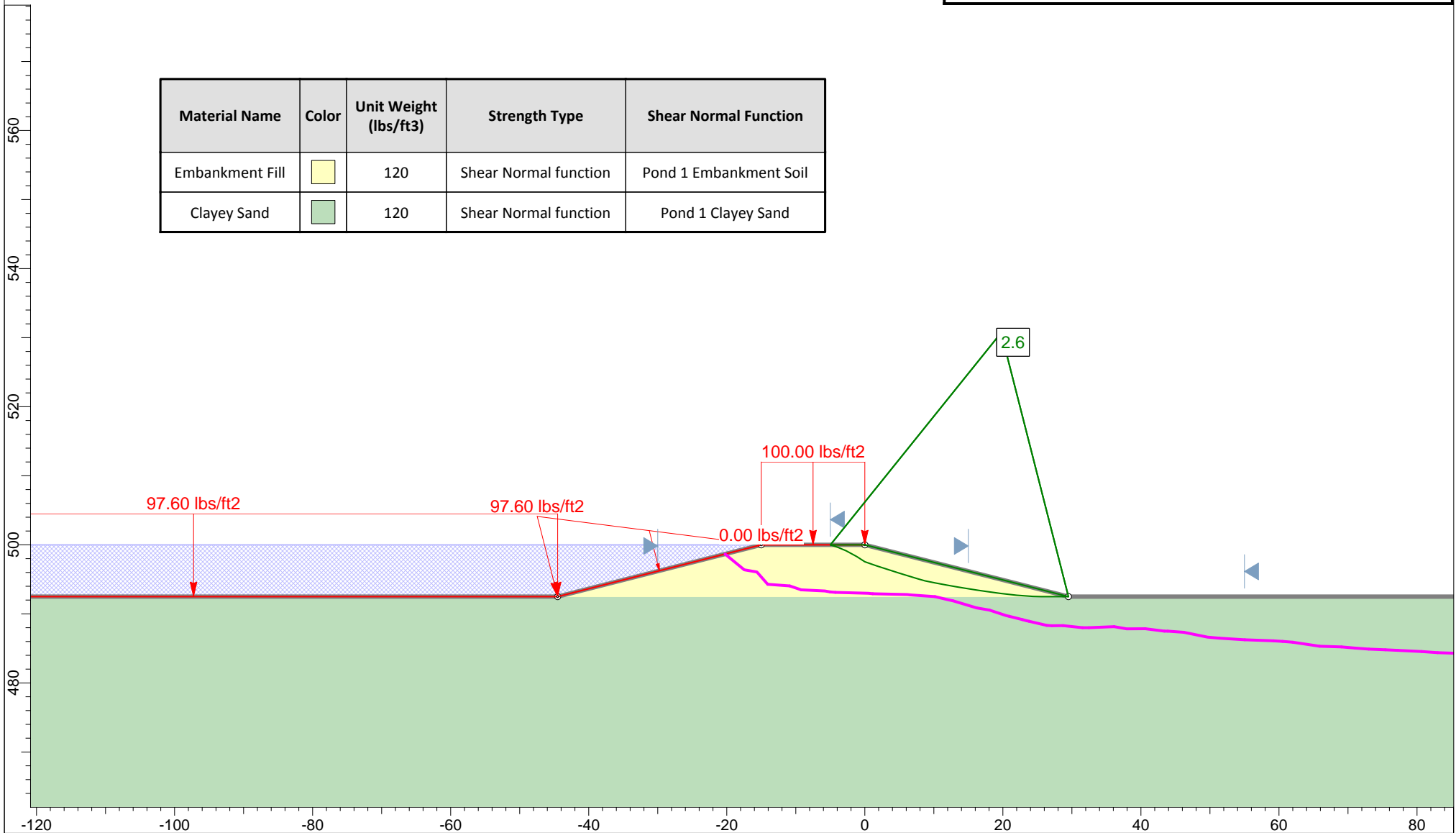



Profile "J" - Maximum Pool
Ash Pond Berms - Spruce/Deely Generation Units

Raba Kistner Consultants, Inc.
ASA12-098-00

Figure C-25a



Global Stability Analysis

Material Name	Color	Unit Weight (lbs/ft ³)	Strength Type	Shear Normal Function
Embankment Fill		120	Shear Normal function	Pond 1 Embankment Soil
Clayey Sand		120	Shear Normal function	Pond 1 Clayey Sand

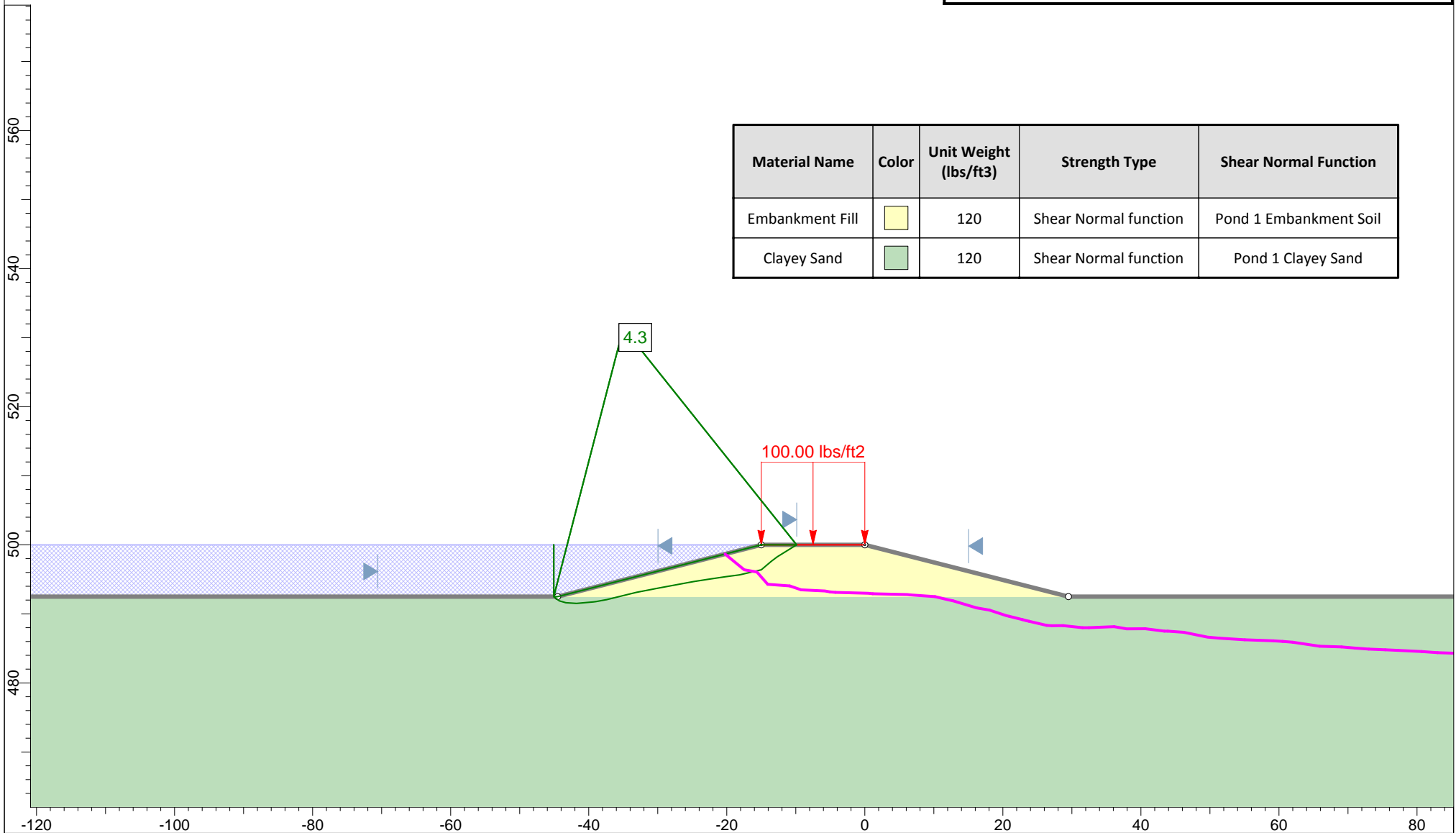

Profile "J" - Maximum Pool
Ash Pond Berms - Spruce/Deely Generation Units

Raba Kistner Consultants, Inc.
ASA12-098-00

Figure C-25b



Global Stability Analysis

Material Name	Color	Unit Weight (lbs/ft ³)	Strength Type	Shear Normal Function
Embankment Fill		120	Shear Normal function	Pond 1 Embankment Soil
Sandy Clay		120	Shear Normal function	Pond 1 Sandy Clay

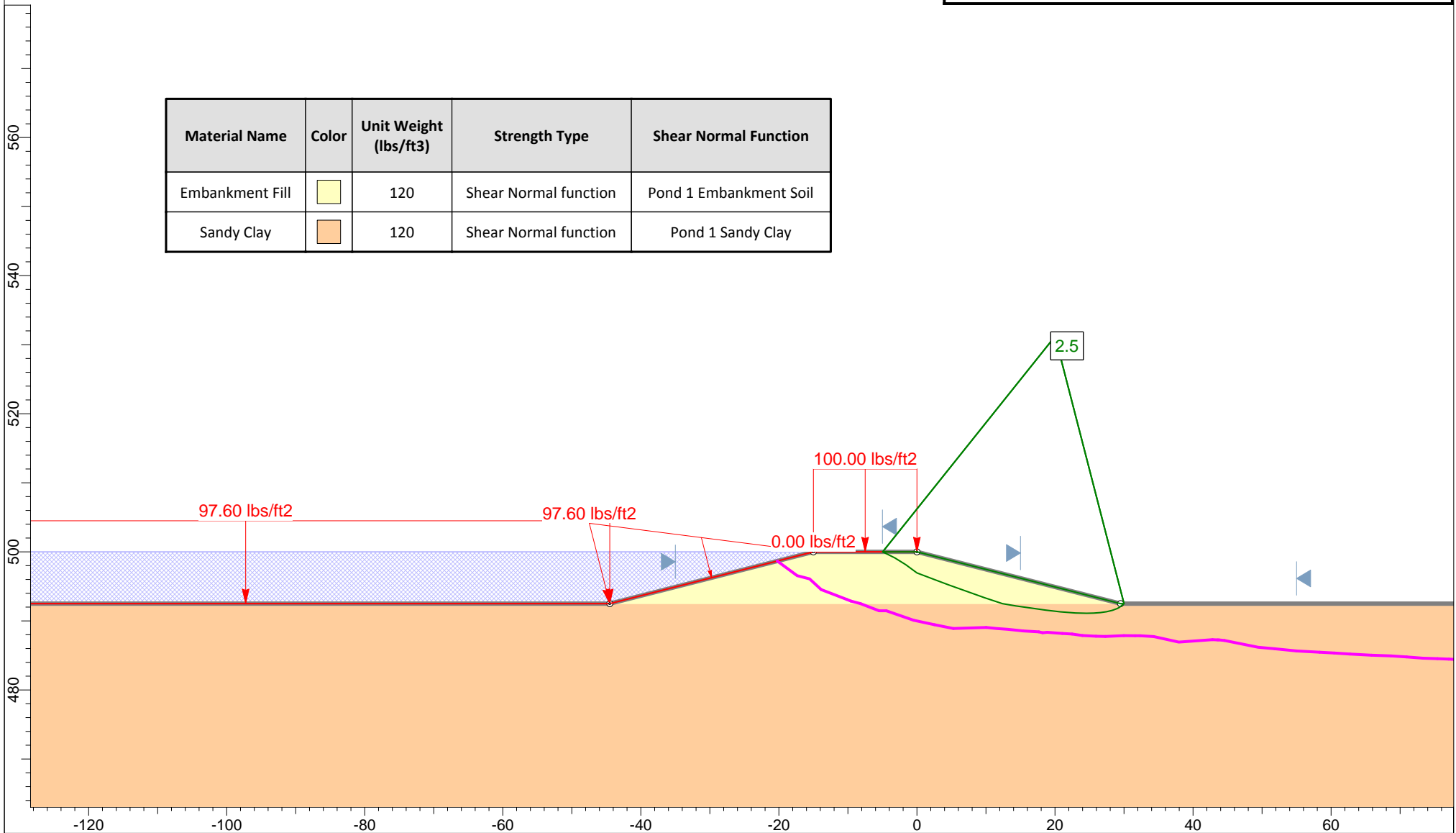



Profile "K" - Maximum Pool
Ash Pond Berms - Spruce/Deely Generation Units

Raba Kistner Consultants, Inc.
ASA12-098-00

Figure C-26a



Global Stability Analysis

Material Name	Color	Unit Weight (lbs/ft ³)	Strength Type	Shear Normal Function
Embankment Fill		120	Shear Normal function	Pond 1 Embankment Soil
Sandy Clay		120	Shear Normal function	Pond 1 Sandy Clay

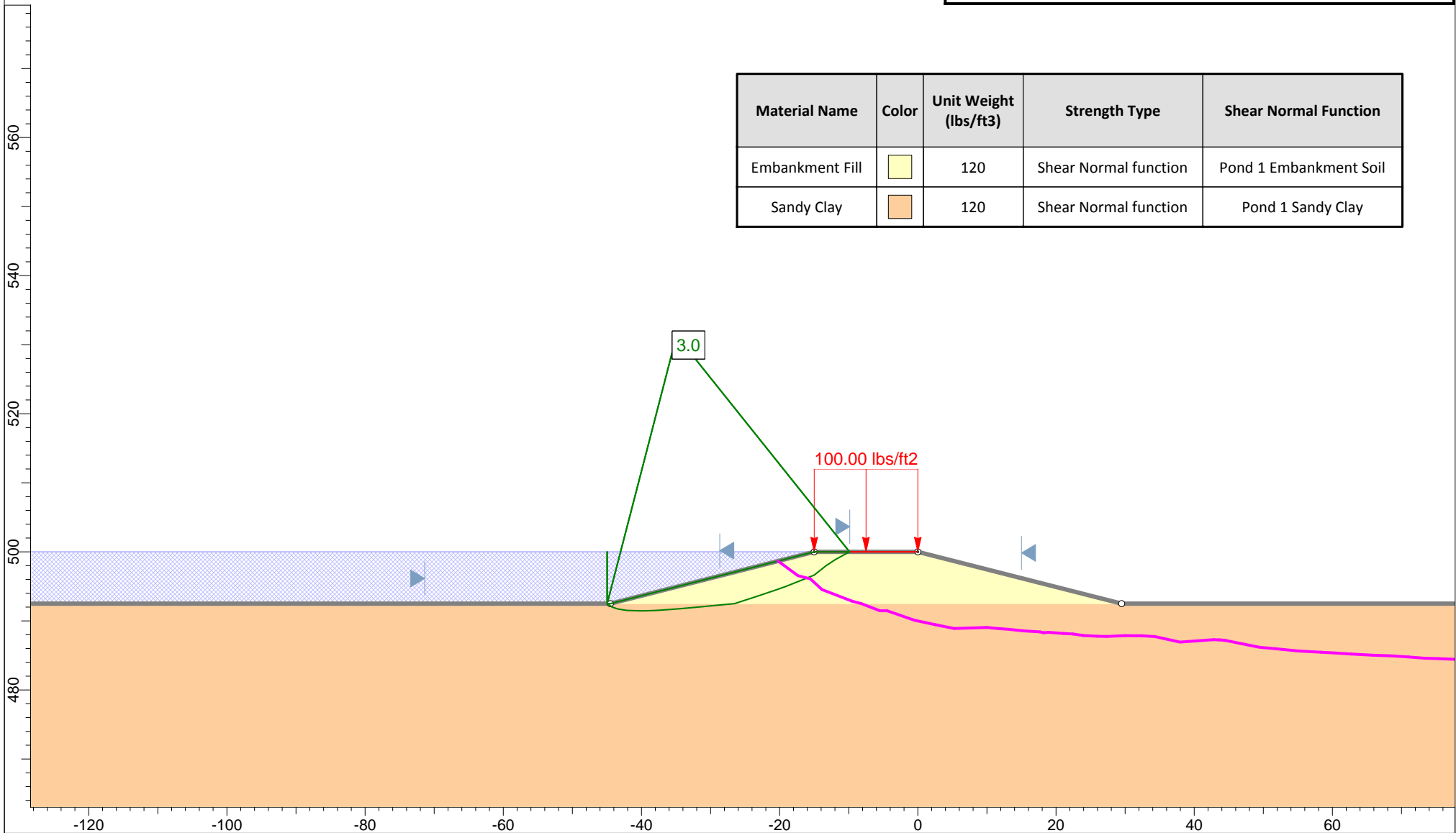



Profile "K" - Maximum Pool
Ash Pond Berms - Spruce/Deely Generation Units

Raba Kistner Consultants, Inc.
ASA12-098-00

Figure C-26b



Global Stability Analysis

Material Name	Color	Unit Weight (lbs/ft ³)	Strength Type	Shear Normal Function
Embankment Fill		120	Shear Normal function	Pond 1 Embankment Soil
Clayey Sand		120	Shear Normal function	Pond 1 Clayey Sand
Sandy Clay		120	Shear Normal function	Pond 1 Sandy Clay

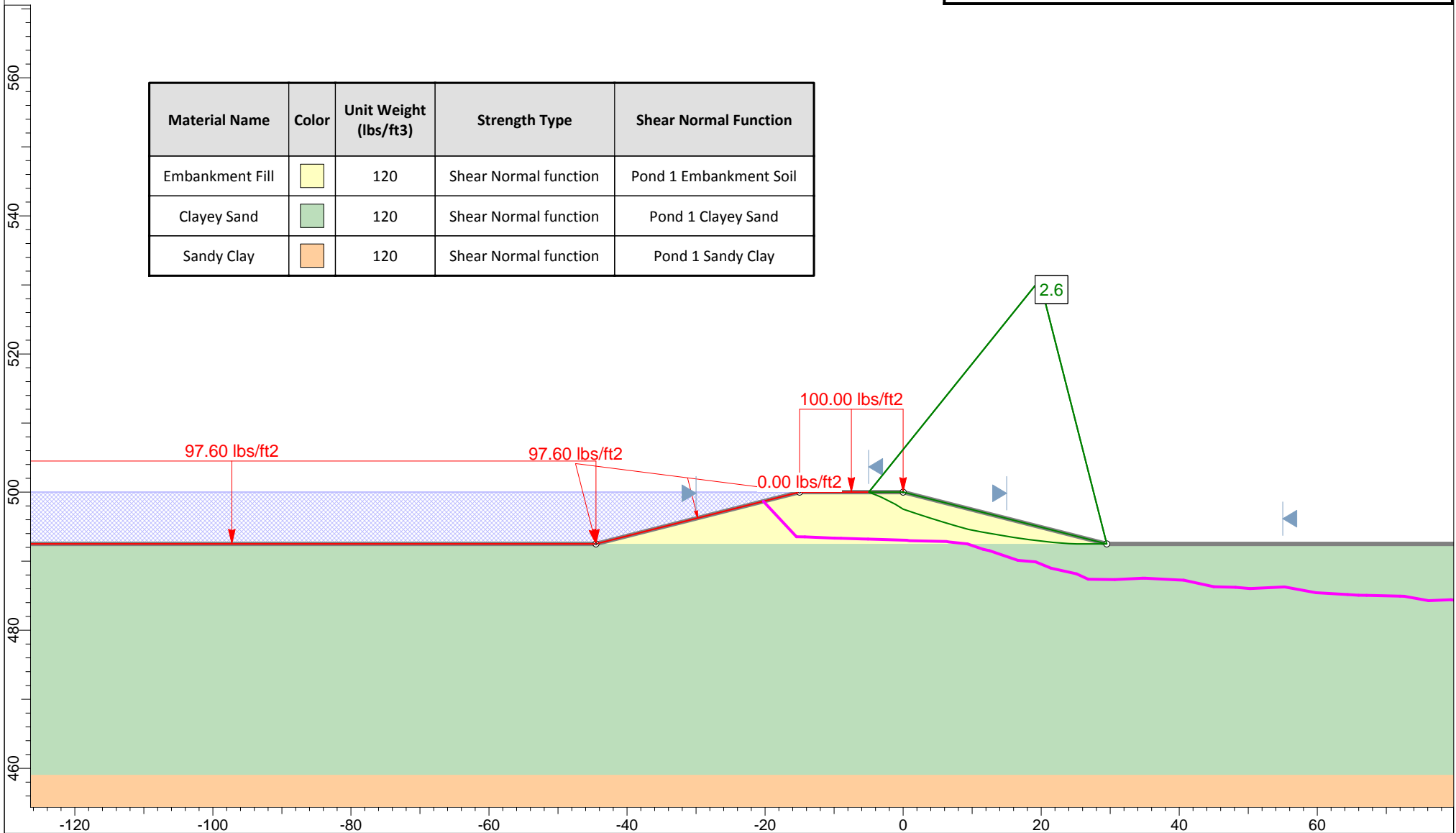



Profile "L" - Maximum Pool
Ash Pond Berms - Spruce/Deely Generation Units

Raba Kistner Consultants, Inc.
ASA12-098-00

Figure C-27a



Global Stability Analysis

Material Name	Color	Unit Weight (lbs/ft ³)	Strength Type	Shear Normal Function
Embankment Fill		120	Shear Normal function	Pond 1 Embankment Soil
Clayey Sand		120	Shear Normal function	Pond 1 Clayey Sand
Sandy Clay		120	Shear Normal function	Pond 1 Sandy Clay

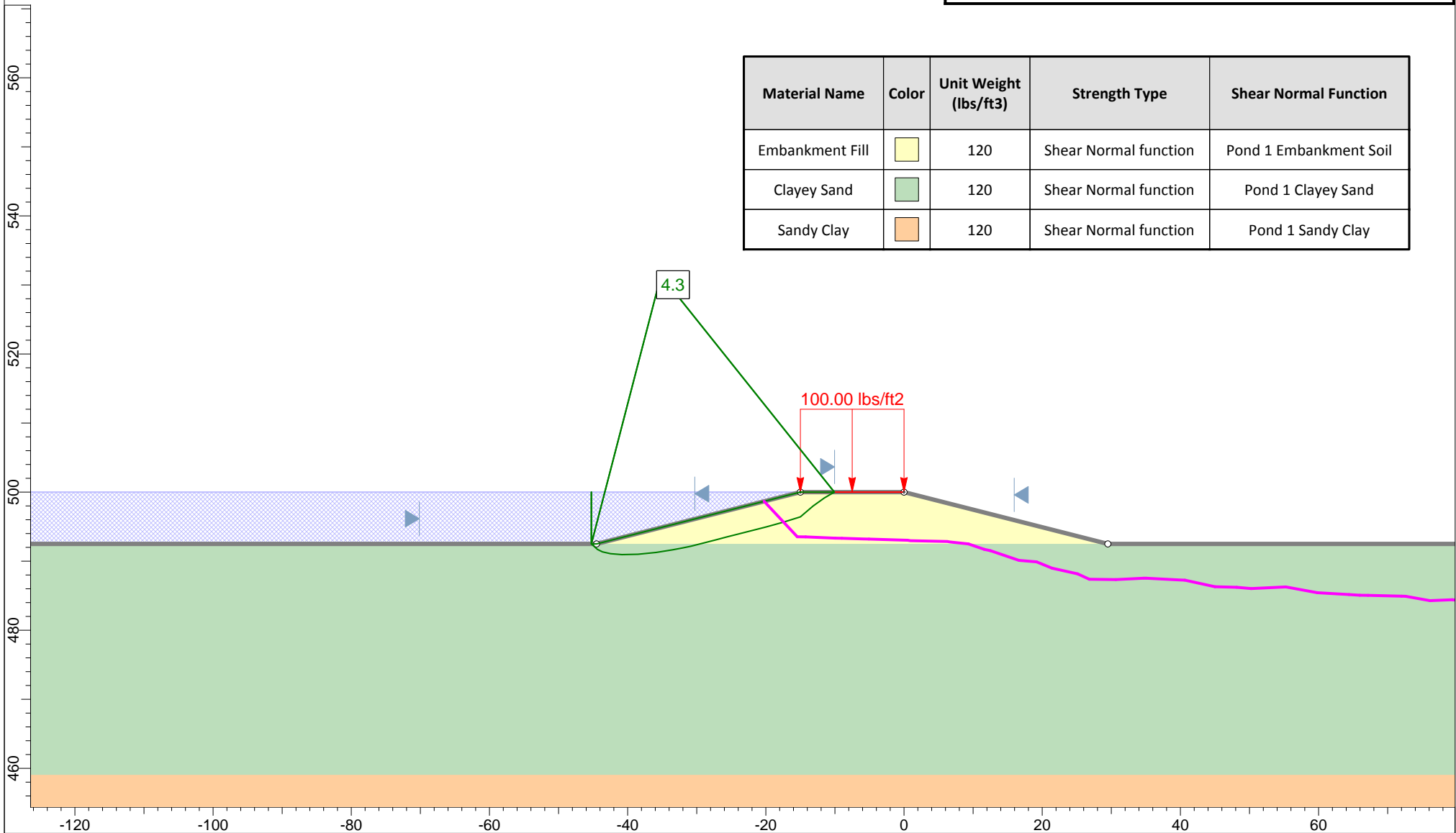



Profile "L" - Maximum Pool
Ash Pond Berms - Spruce/Deely Generation Units

Raba Kistner Consultants, Inc.
ASA12-098-00

Figure C-27b



Global Stability Analysis

Material Name	Color	Unit Weight (lbs/ft ³)	Strength Type	Shear Normal Function
Embankment Fill		120	Shear Normal function	Pond 1 Embankment Soil
Clayey Sand		120	Shear Normal function	Pond 1 Clayey Sand
Sandy Clay		120	Shear Normal function	Pond 1 Sandy Clay

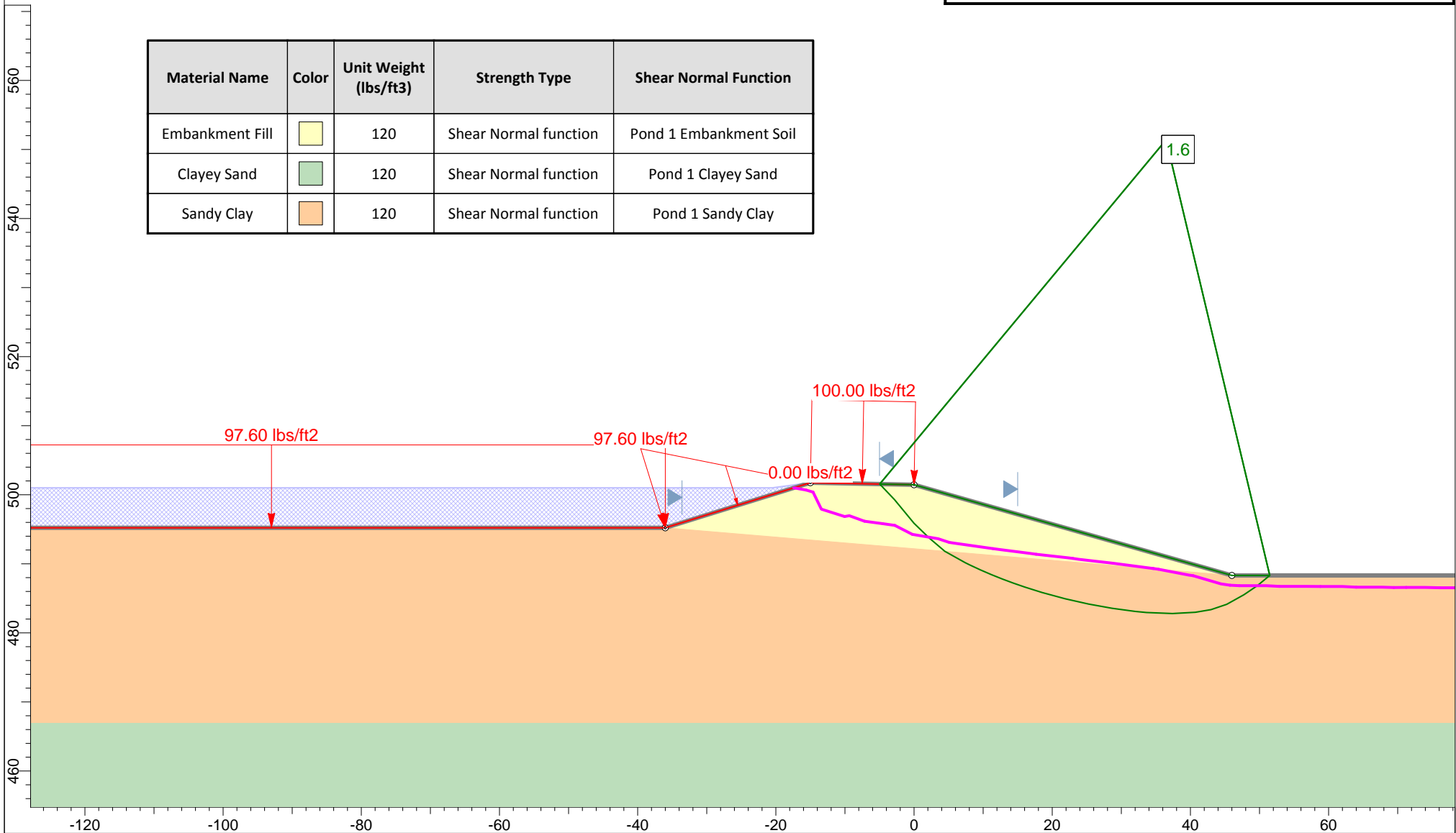

Profile "M" - Maximum Pool
Ash Pond Berms - Spruce/Deely Generation Units

Raba Kistner Consultants, Inc.
ASA12-098-00

Figure C-28a



Global Stability Analysis

Material Name	Color	Unit Weight (lbs/ft ³)	Strength Type	Shear Normal Function
Embankment Fill	Yellow	120	Shear Normal function	Pond 1 Embankment Soil
Clayey Sand	Green	120	Shear Normal function	Pond 1 Clayey Sand
Sandy Clay	Orange	120	Shear Normal function	Pond 1 Sandy Clay

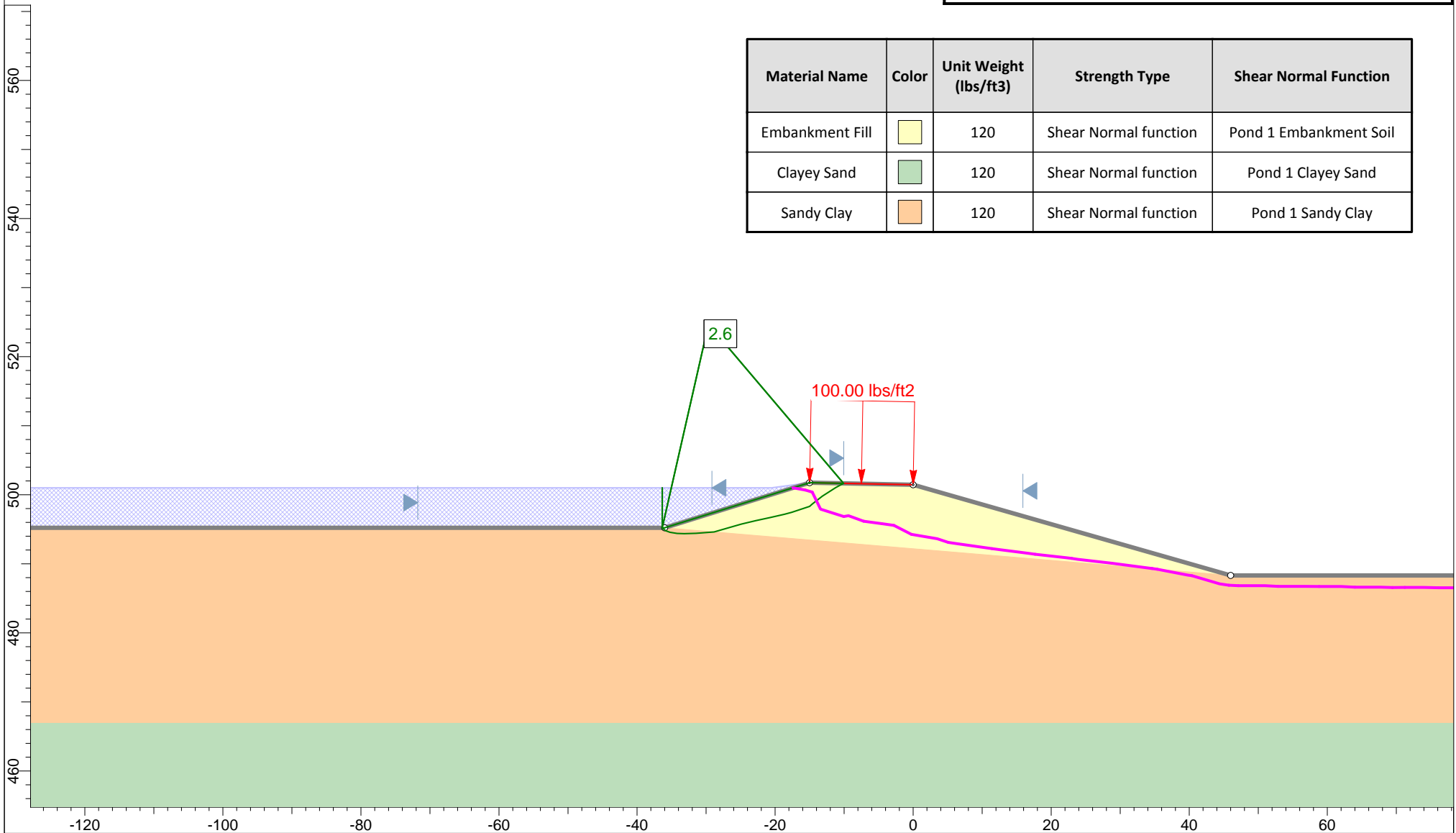



Profile "M" - Maximum Pool
Ash Pond Berms - Spruce/Deely Generation Units

Raba Kistner Consultants, Inc.
ASA12-098-00

Figure C-28b



Global Stability Analysis

Material Name	Color	Unit Weight (lbs/ft ³)	Strength Type	Shear Normal Function
Embankment Fill		120	Shear Normal function	Pond 2 Embankment Soil
Clayey Sand		120	Shear Normal function	Pond 2 Clayey Sand

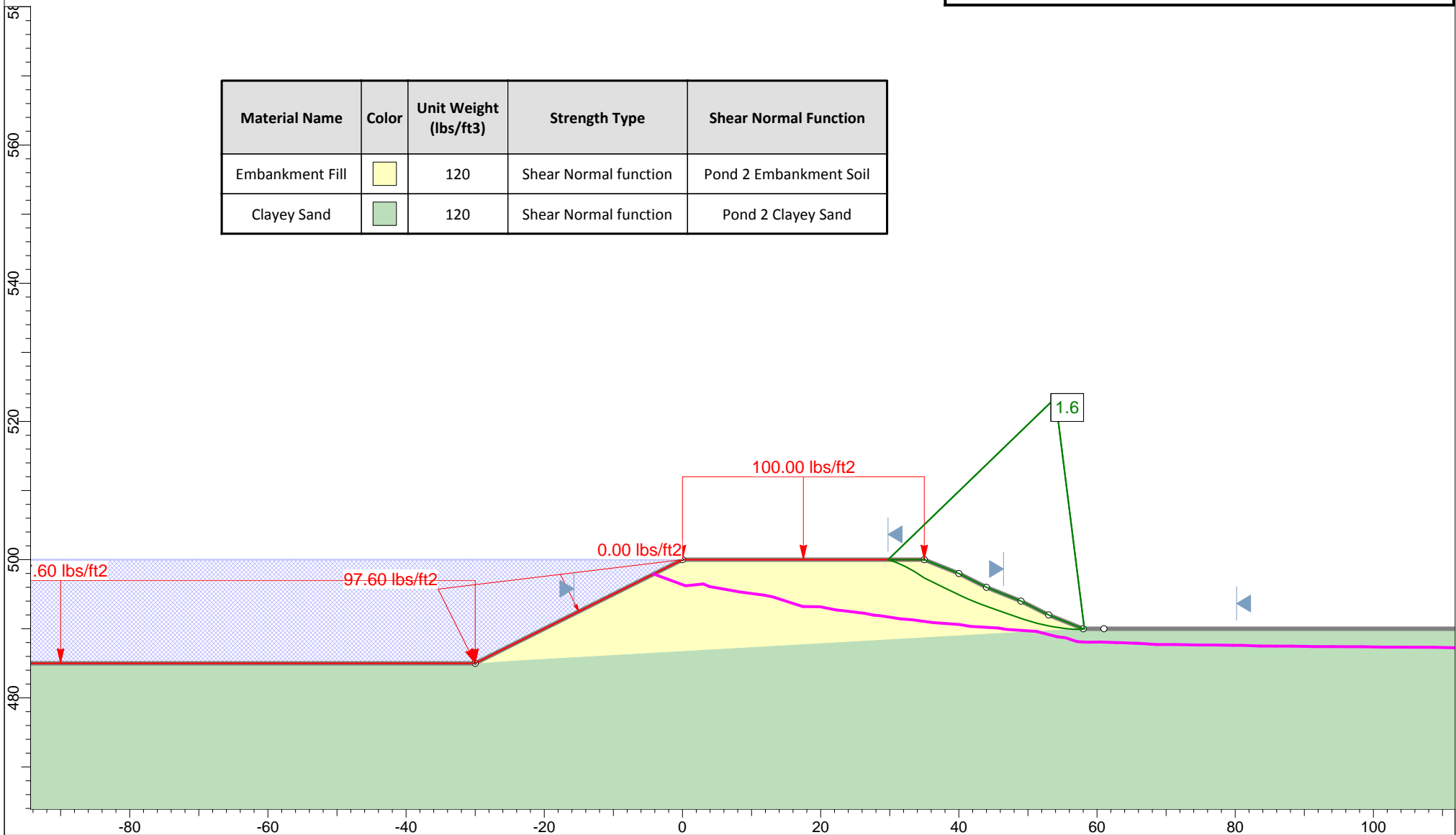



Profile "N" - Maximum Pool
Ash Pond Berms - Spruce/Deely Generation Units

Raba Kistner Consultants, Inc.
ASA12-098-00

Figure C-29a



Global Stability Analysis

Material Name	Color	Unit Weight (lbs/ft ³)	Strength Type	Shear Normal Function
Embankment Fill		120	Shear Normal function	Pond 2 Embankment Soil
Clayey Sand		120	Shear Normal function	Pond 2 Clayey Sand

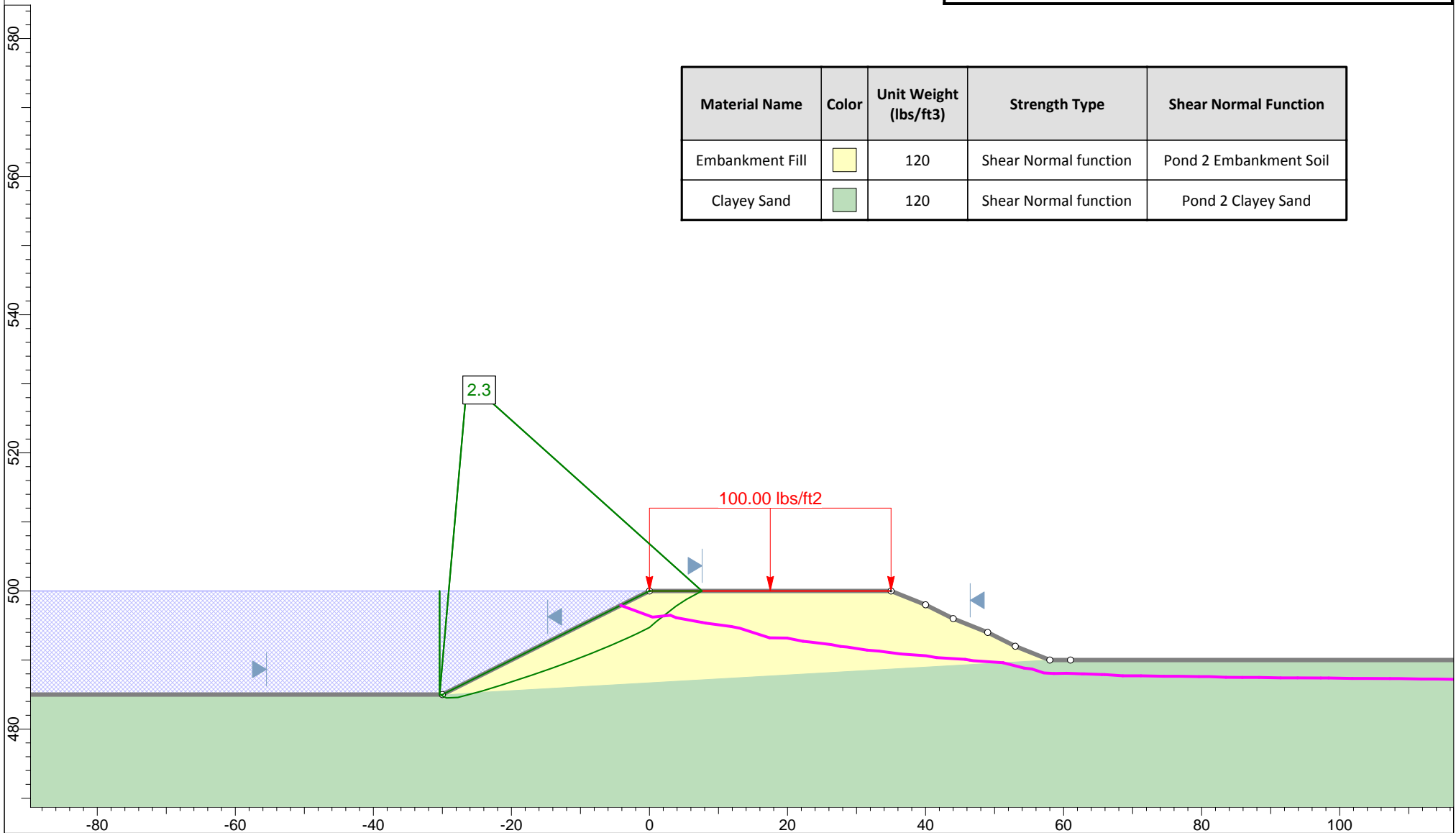

Profile "N" - Maximum Pool
Ash Pond Berms - Spruce/Deely Generation Units

Raba Kistner Consultants, Inc.
ASA12-098-00

Figure C-29b



APPENDIX D

SEISMIC ANALYSES

Design Maps Summary Report

User-Specified Input

Building Code Reference Document 2009 NEHRP Recommended Seismic Provisions
(which makes use of 2008 USGS hazard data)

Site Coordinates 29.30821°N, 98.3168°W

Site Soil Classification Site Class D - "Stiff Soil"

Risk Category I/II/III

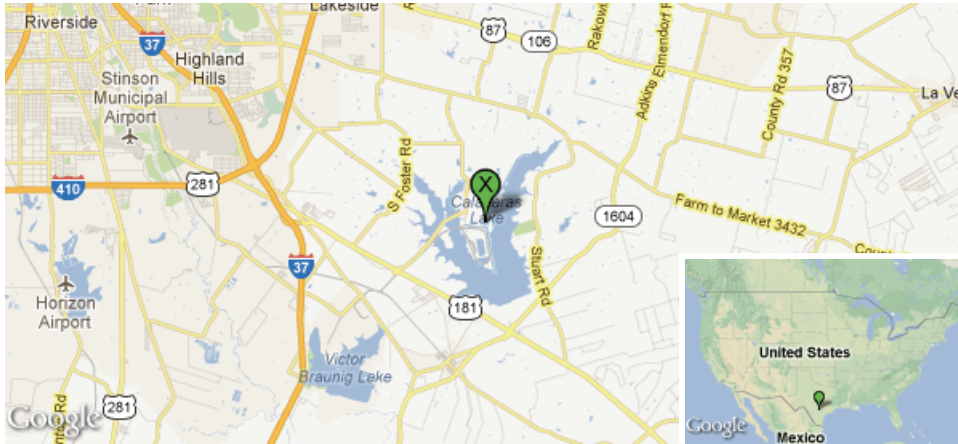

USGS-Provided Output

$S_s = 0.092 \text{ g}$	$S_{MS} = 0.147 \text{ g}$	$S_{DS} = 0.098 \text{ g}$
$S_1 = 0.031 \text{ g}$	$S_{M1} = 0.075 \text{ g}$	$S_{D1} = 0.050 \text{ g}$

For information on how the S_s and S_1 values above have been calculated from probabilistic (risk-targeted) and deterministic ground motions in the direction of maximum horizontal response, please [view the detailed report](#).

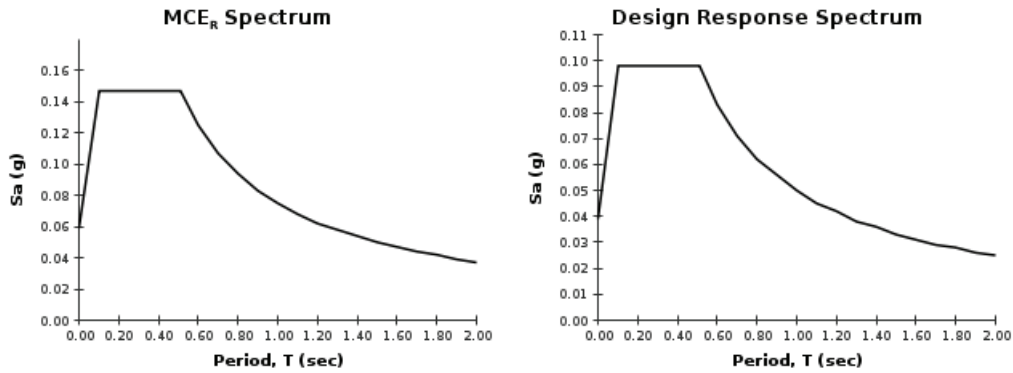

For PGA_M , T_L , C_{RSF} , and C_{R1} values, please [view the detailed report](#).

Although this information is a product of the U.S. Geological Survey, we provide no warranty, expressed or implied, as to the accuracy of the data contained therein. This tool is not a substitute for technical subject-matter knowledge.

Probability of earthquake with $M > 5.0$ within 250 years & 50 km

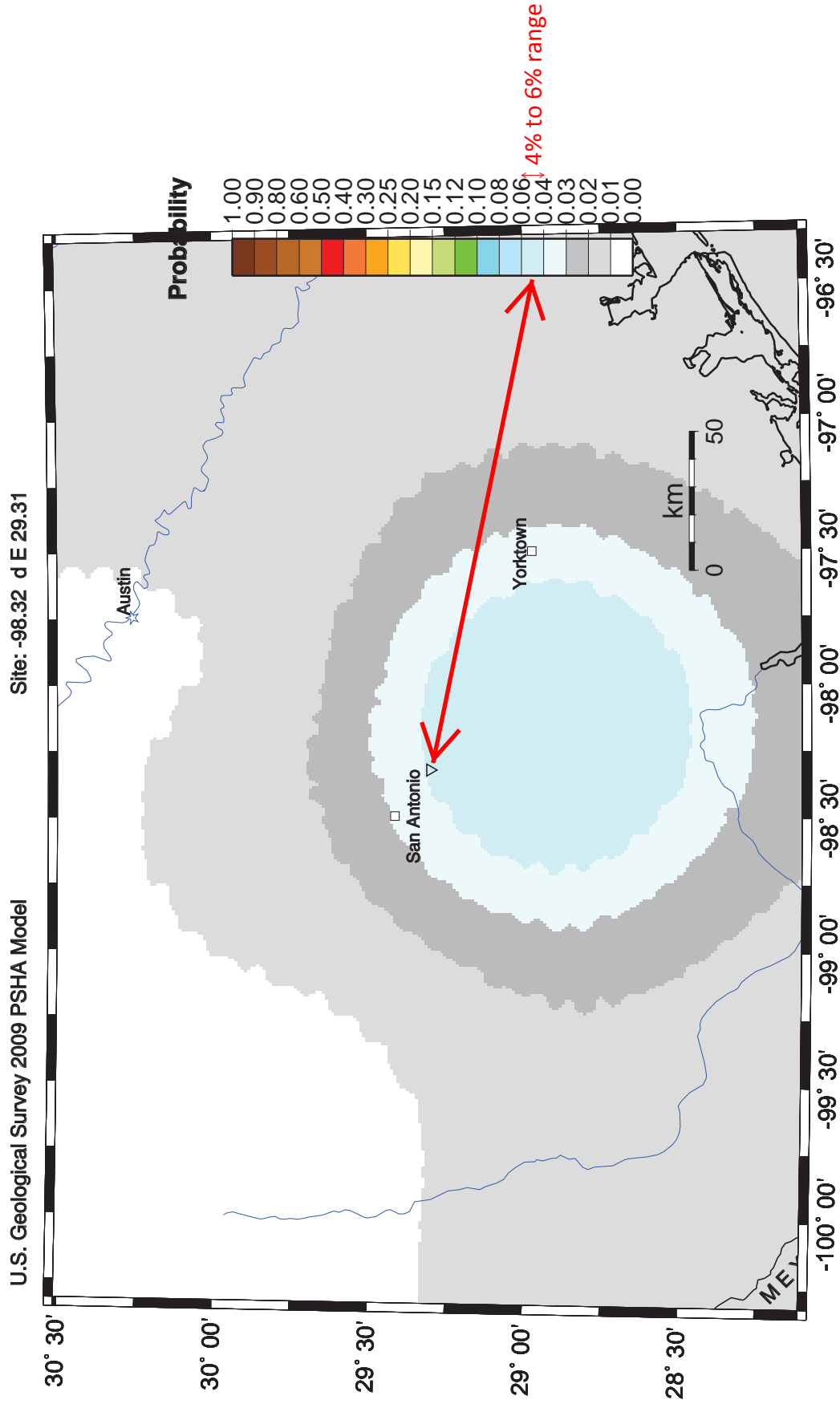

GMT 2012 Nov 19 15:18:38 Earthquake probabilities from USGS OFR 08-1128 PSHA. 50 km maximum horizontal distance. Site of interest: triangle. Epicenters mbs=5 black circles; rivers blue.

USGS Design Maps Detailed Report**2009 NEHRP Recommended Seismic Provisions (29.30821°N, 98.3168°W)****Section 11.4.1 — Mapped Acceleration Parameters and Risk Coefficients**

Note: Ground motion values contoured on Figures 22-1, 2, 5, & 6 below are for the direction of maximum horizontal spectral response acceleration. They have been converted from corresponding geometric mean ground motions computed by the USGS by applying factors of 1.1 (to obtain S_{SUH} and S_{SD}) and 1.3 (to obtain S_{1UH} and S_{1D}). Maps in the 2009 NEHRP Provisions are provided for Site Class B. Adjustments for other Site Classes are made, as needed, in Section 11.4.3.

Figure 22-1: Uniform-Hazard (2% in 50-Year) Ground Motions of 0.2-Second Spectral Response Acceleration (5% of Critical Damping), Site Class B

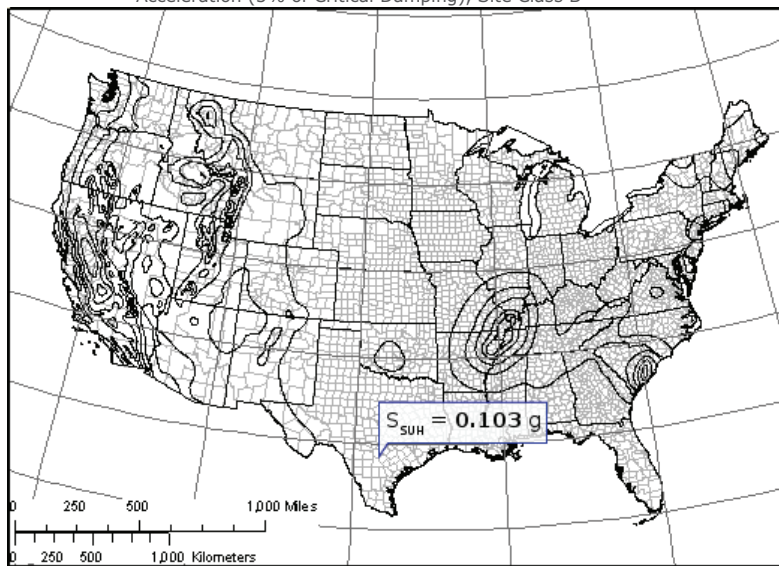

Figure 22-2: Uniform-Hazard (2% in 50-Year) Ground Motions of 1.0-Second Spectral Response Acceleration (5% of Critical Damping), Site Class B

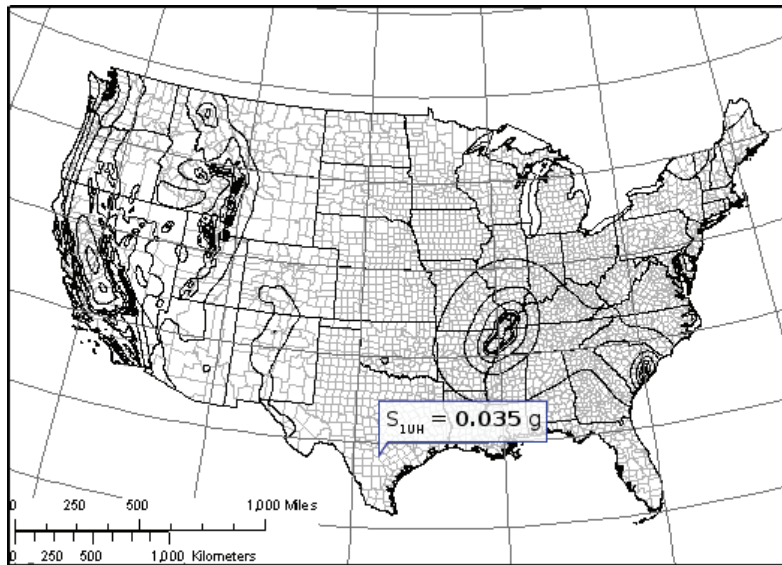

Figure 22-3: Risk Coefficient at 0.2-Second Spectral Response Period

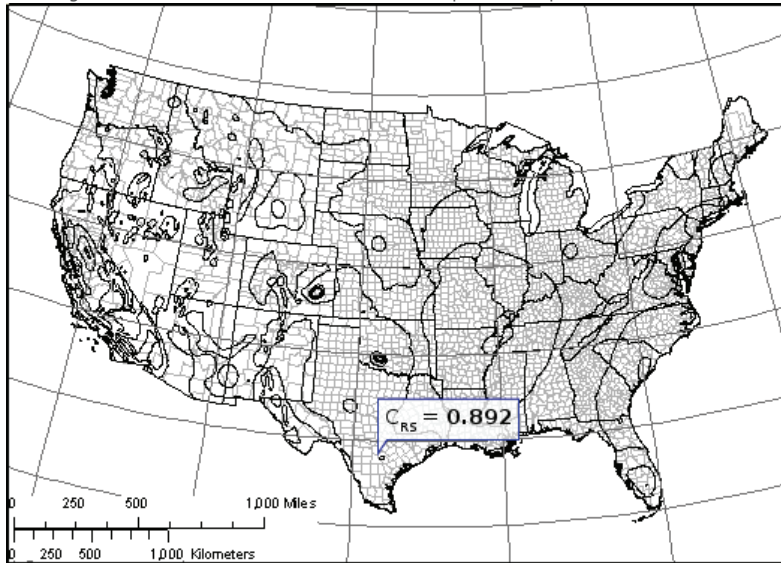

Figure 22-4: Risk Coefficient at 1.0-Second Spectral Response Period

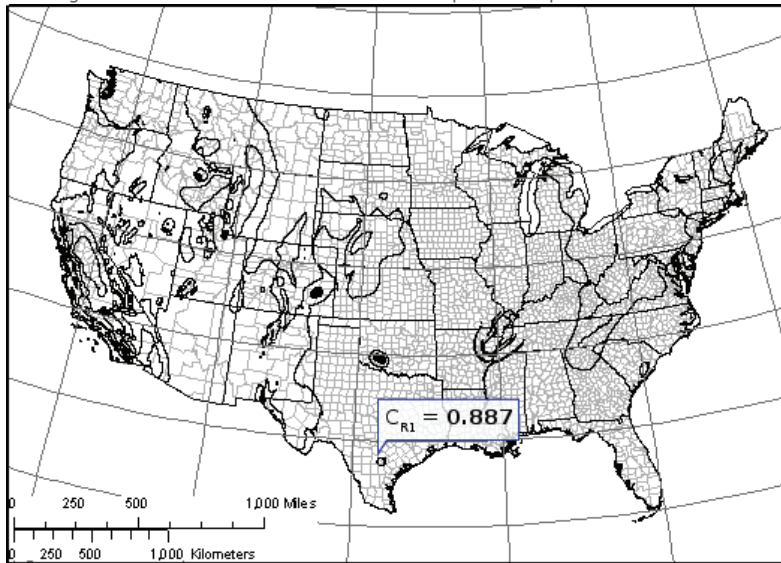

Figure 22-5: Deterministic Ground Motions of 0.2-Second Spectral Response Acceleration (5% of Critical Damping), Site Class B

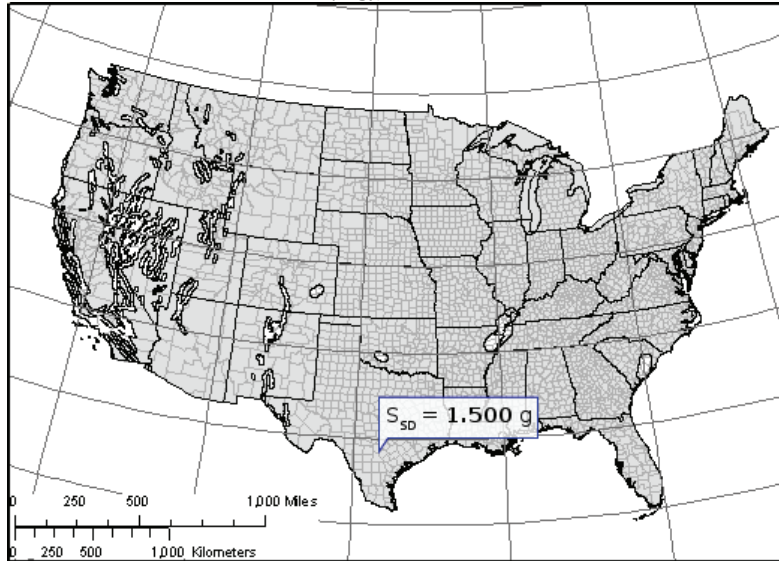
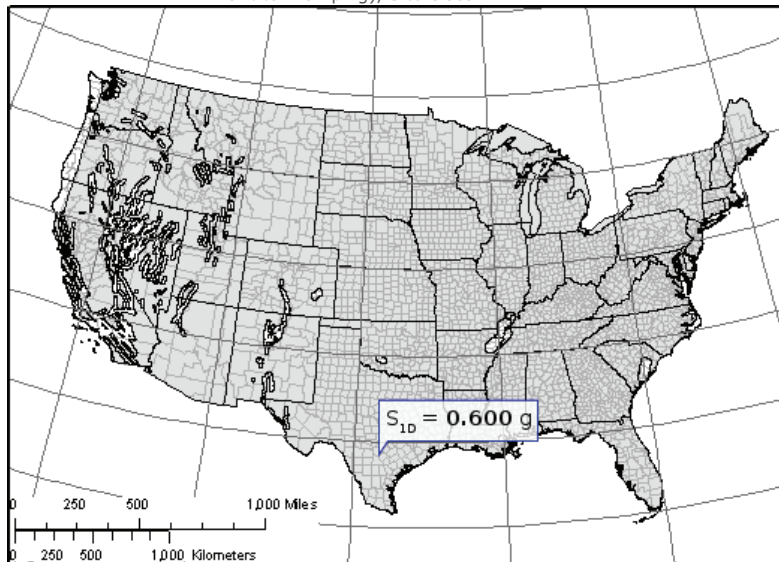

Figure 22-6: Deterministic Ground Motions of 1.0-Second Spectral Response Acceleration (5% of Critical Damping), Site Class B



Section 11.4.2 – Site Class

The authority having jurisdiction (not the USGS), site-specific geotechnical data, and/or the default has classified the site as Site Class D, based on the site soil properties in accordance with Chapter 20.

Table 20.3-1 Site Classification

Site Class	\bar{v}_s	\bar{N} or \bar{N}_{ch}	\bar{s}_u
A. Hard Rock	>5,000 ft/s	N/A	N/A
B. Rock	2,500 to 5,000 ft/s	N/A	N/A
C. Very dense soil and soft rock	1,200 to 2,500 ft/s	>50	>2,000 psf
D. Stiff Soil	600 to 1,200 ft/s	15 to 50	1,000 to 2,000 psf
E. Soft clay soil	<600 ft/s	<15	<1,000 psf
Any profile with more than 10 ft of soil having the characteristics:			
<ul style="list-style-type: none"> • Plasticity index $PI > 20$, • Moisture content $w \geq 40\%$, and • Undrained shear strength $\bar{s}_u < 500$ psf 			
F. Soils requiring site response analysis in accordance with Section 21.1	See Section 20.3.1		

For SI: 1ft/s = 0.3048 m/s 1lb/ft² = 0.0479 kN/m²

Section 11.4.3 – Site Coefficients, Risk Coefficients, and Risk-Targeted Maximum Considered Earthquake (MCE_R) Spectral Response Acceleration Parameters

Equation (11.4-1): $C_{RS} S_{SUH} = 0.892 \times 0.103 = 0.092 \text{ g}$

Equation (11.4-2): $S_{SD} = 1.500 \text{ g}$

$S_s \equiv \text{"Lesser of values from Equations (11.4-1) and (11.4-2)"} = 0.092 \text{ g}$

Equation (11.4-3): $C_{R1} S_{1UH} = 0.887 \times 0.035 = 0.031 \text{ g}$

Equation (11.4-4): $S_{1D} = 0.600 \text{ g}$

$S_1 \equiv \text{"Lesser of values from Equations (11.4-3) and (11.4-4)"} = 0.031 \text{ g}$

Table 11.4-1: Site Coefficient F_a

Site Class	Spectral Response Acceleration Parameter at Short Period				
	$S_s \leq 0.25$	$S_s = 0.5$	$S_s = 0.75$	$S_s = 1$	$S_s \geq 1.25$
A	0.8	0.8	0.8	0.8	0.8
B	1.0	1.0	1.0	1.0	1.0
C	1.2	1.2	1.1	1.0	1.0
D	1.6	1.4	1.2	1.1	1.0
E	2.5	1.7	1.2	0.9	0.9
F	See Section 11.4.7 of ASCE 7				

Note: Use straight-line interpolation for intermediate values of S_s

For Site Class = D and $S_s = 0.092$ g, $F_a = 1.600$

Table 11.4-2: Site Coefficient F_v

Site Class	Spectral Response Acceleration Parameter at 1-Second Period				
	$S_1 \leq 0.1$	$S_1 = 0.2$	$S_1 = 0.3$	$S_1 = 0.4$	$S_1 \geq 0.5$
A	0.8	0.8	0.8	0.8	0.8
B	1.0	1.0	1.0	1.0	1.0
C	1.7	1.6	1.5	1.4	1.3
D	2.4	2.0	1.8	1.6	1.5
E	3.5	3.2	2.8	2.4	2.4
F	See Section 11.4.7 of ASCE 7				

Note: Use straight-line interpolation for intermediate values of S_1

For Site Class = D and $S_1 = 0.031$ g, $F_v = 2.400$

Equation (11.4-5): $S_{MS} = F_a S_s = 1.600 \times 0.092 = 0.147 \text{ g}$

Equation (11.4-6): $S_{M1} = F_v S_1 = 2.400 \times 0.031 = 0.075 \text{ g}$

Section 11.4.4 – Design Spectral Acceleration Parameters

Equation (11.4-7): $S_{DS} = \frac{2}{3} S_{MS} = \frac{2}{3} \times 0.147 = 0.098 \text{ g}$

Equation (11.4-8): $S_{D1} = \frac{2}{3} S_{M1} = \frac{2}{3} \times 0.075 = 0.050 \text{ g}$

Section 11.4.5 – Design Response Spectrum

Figure 22-7: Long-period Transition Period, T_L (s)

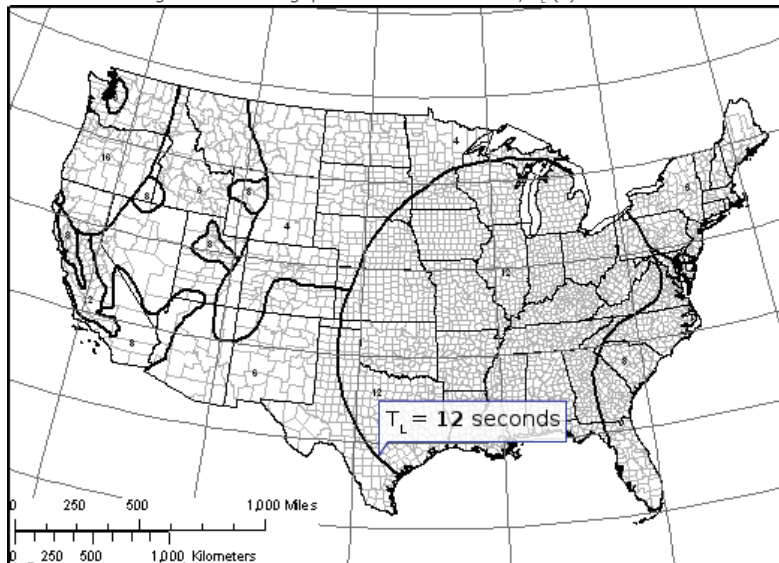

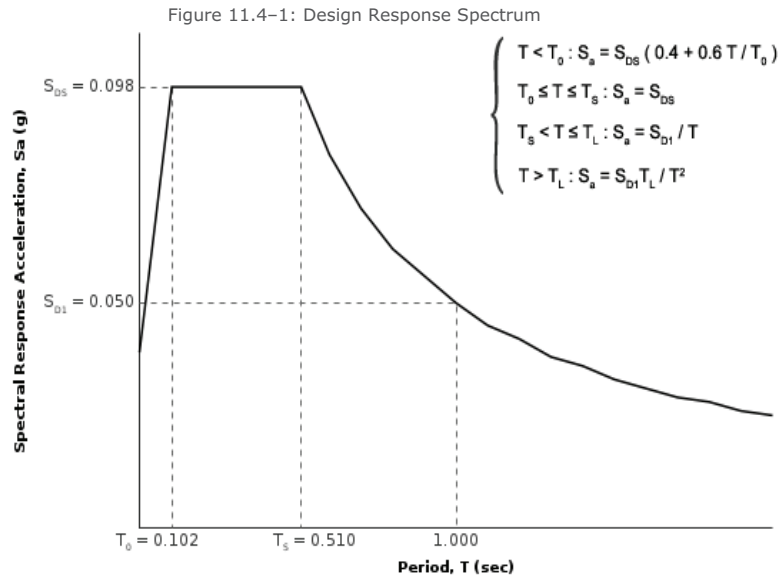

Section 11.4.6 — MCE_R Response Spectrum

The MCE_R response spectrum is determined by multiplying the design response spectrum above by 1.5.

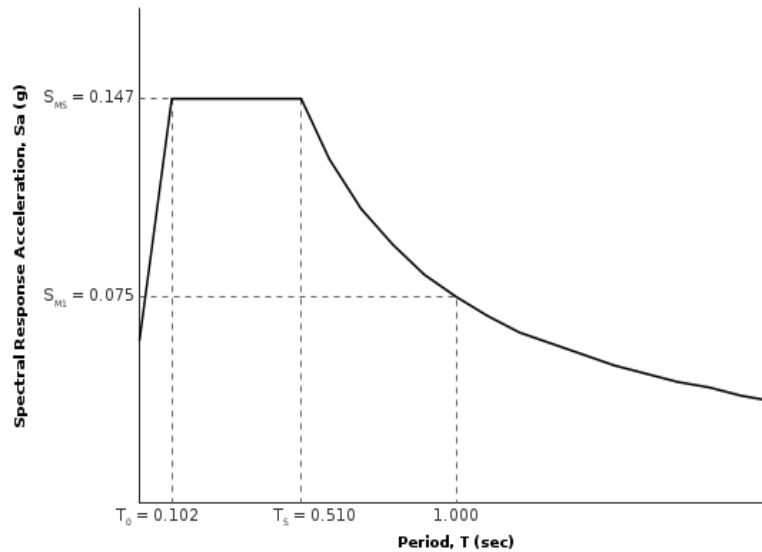

Section 11.8.3 – Additional Geotechnical Investigation Report Requirements for Seismic Design Categories D through F

Table 11.8-1: Site Coefficient F_{PGA}

Site Class	Mapped MCE Geometric Mean Peak Ground Acceleration, PGA				
	PGA ≤ 0.1	PGA = 0.2	PGA = 0.3	PGA = 0.4	PGA ≥ 0.5
A	0.8	0.8	0.8	0.8	0.8
B	1.0	1.0	1.0	1.0	1.0
C	1.2	1.2	1.1	1.0	1.0
D	1.6	1.4	1.2	1.1	1.0
E	2.5	1.7	1.2	0.9	0.9
F	See Section 11.4.7 of ASCE 7				

Note: Use straight-line interpolation for intermediate values of PGA

For Site Class = D and PGA = 0.047 g, $F_{PGA} = 1.600$

Mapped PGA

PGA = 0.047 g

Equation (11.8-1):

$$PGA_M = F_{PGA}PGA = 1.600 \times 0.047 = 0.075 \text{ g}$$

STRUCTURAL COMPONENTS AND SYSTEMS

For the Seismic Retrofit of Tilt-Up Buildings

[Home](#) [Mercalli XII](#) [Products](#) [Information](#) [Photos](#) [Contact](#)

[TERMS OF USE](#)

▶ [Information](#) ▶ Seismic Intensity Scales vs Peak Ground Acceleration

Seismic Intensity Scales vs Peak Ground Acceleration

Modified Mercalli Scale and PGA	
MMI	PGA (g)
IV	0.03 and below
V	0.03 - 0.08
VI	0.08 - 0.15
VII	0.15 - 0.25
VIII	0.25 - 0.45
IX	0.45 - 0.60
X	0.60 - 0.80
XI	0.80 - 0.90
XII	0.90 and above

The above table shows the approximate relationship between Modified Mercalli Intensity and Peak Ground Acceleration (PGA).

Richter Magnitude, PGA, and Duration		
Richter Magnitude	PGA (g)	Duration (seconds)
5.0	0.09	2
5.5	0.15	6
6.0	0.22	12

<http://mercallixii.com/information/15-the-richter-scale.html>

11/19/2012

6.5	0.29	18
7.0	0.37	24
7.5	0.45	30
8.0	0.50	34
8.5	0.50	37



The above table shows the approximate relationship between Richter Magnitude, Peak Ground Acceleration (PGA), and duration of strong-phase shaking near the epicenter of earthquakes located in California.

[< Prev](#) [Next >](#)

[Home](#) | [About Mercalli XII](#) | [Contact](#) | [Terms of Use](#)

Copyright © 2004-2012, Mercalli XII, Inc. All Rights Reserved

Global Stability Analysis

Material Name	Color	Unit Weight (lbs/ft3)	Strength Type	Cohesion (psf)	Phi (deg)
Embankment Fill		120	Mohr-Coulomb	350	20
Clayey Sand		120	Mohr-Coulomb	400	20
Clayey Sand Below WT		57.6	Mohr-Coulomb	400	20

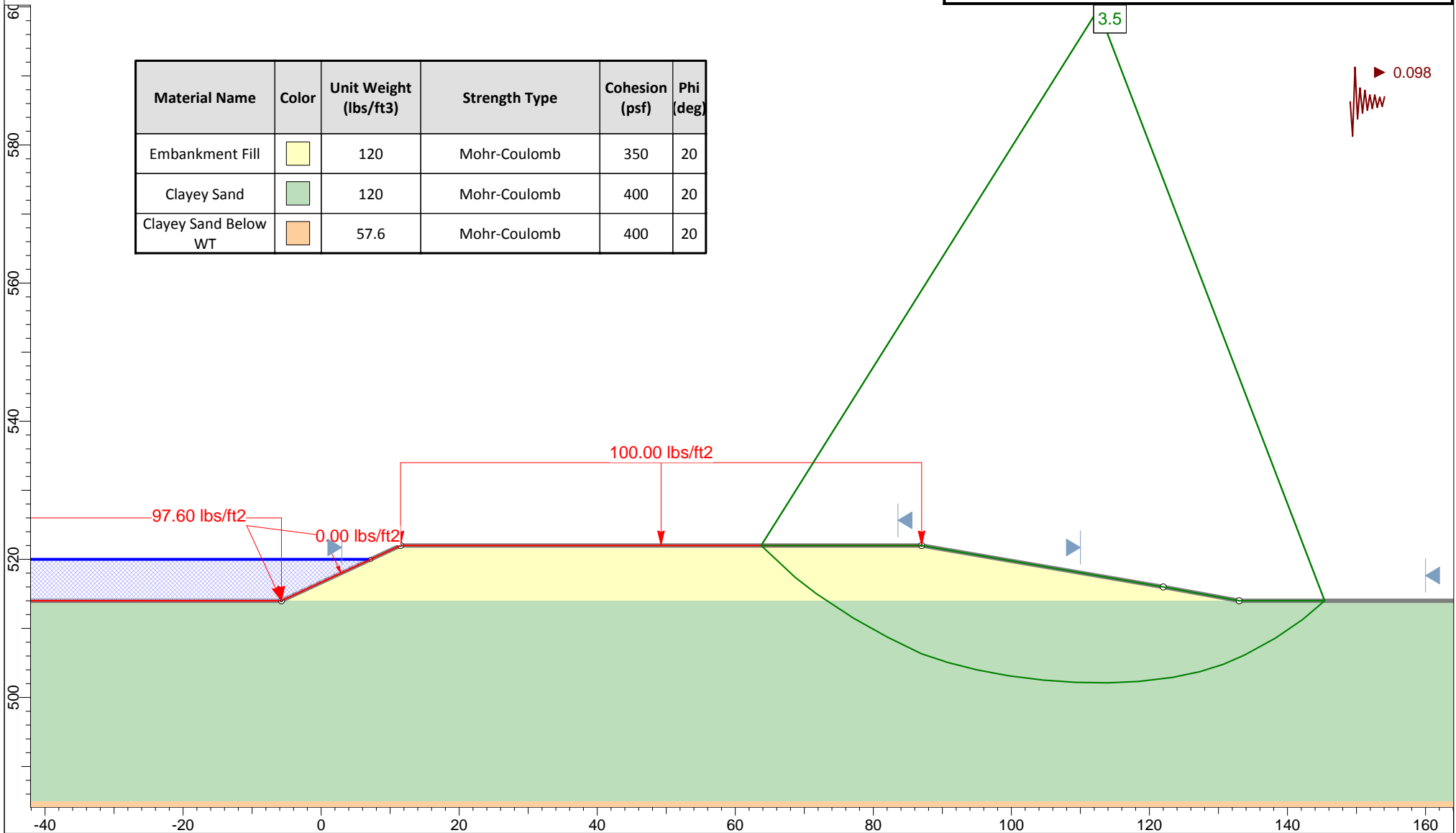

Profile "A" - Steady State
Ash Pond Berms - Spruce/Deely Generation Units

Raba Kistner Consultants, Inc.
ASA12-098-00

Figure D-14a



Global Stability Analysis

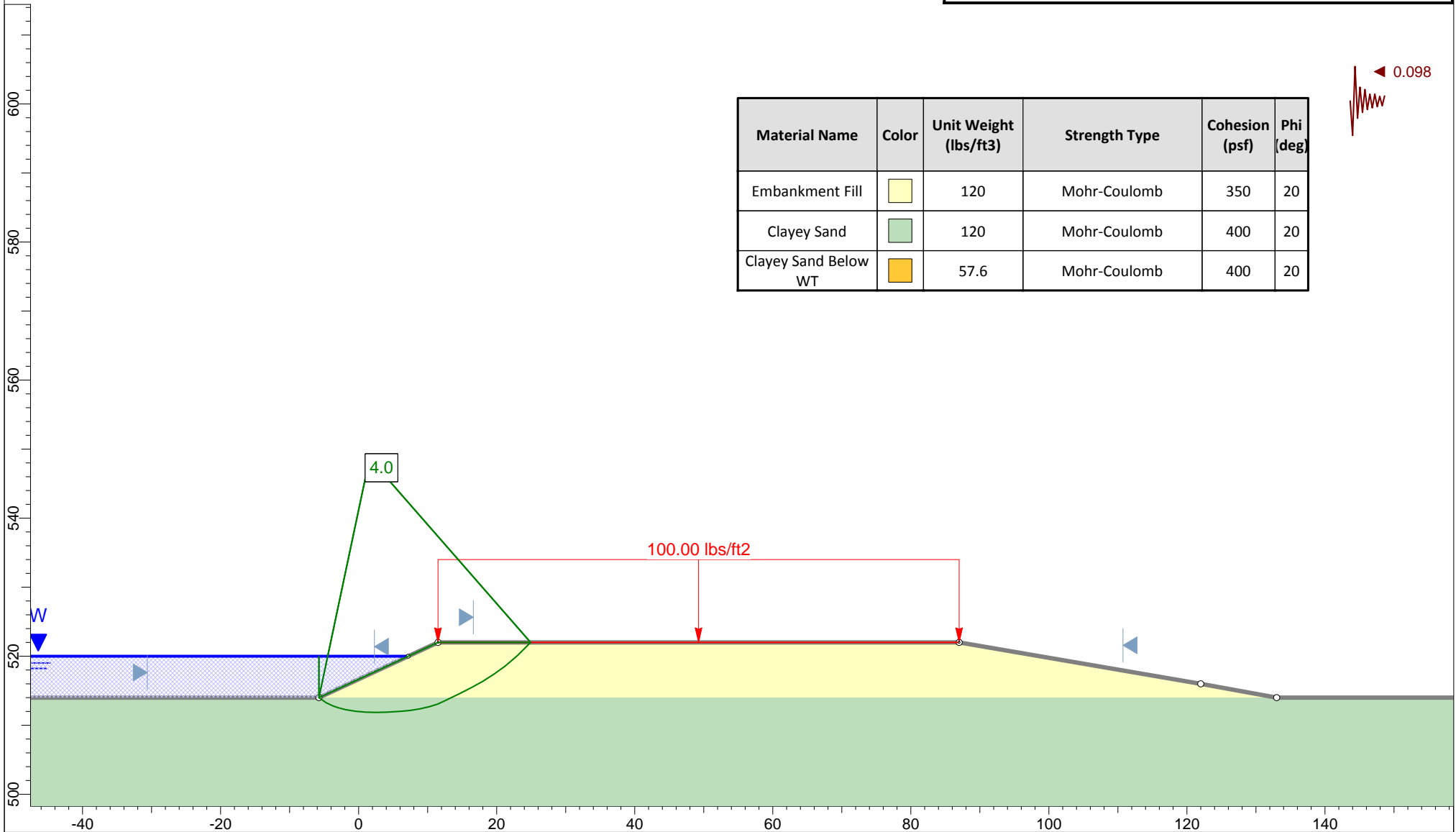

Material Name	Color	Unit Weight (lbs/ft ³)	Strength Type	Cohesion (psf)	Phi (deg)
Embankment Fill		120	Mohr-Coulomb	350	20
Clayey Sand		120	Mohr-Coulomb	400	20
Clayey Sand Below WT		57.6	Mohr-Coulomb	400	20





Profile "A" - Steady State
Ash Pond Berms - Spruce/Deely Generation Units

Raba Kistner Consultants, Inc.
ASA12-098-00

Figure D-14b



Global Stability Analysis

Material Name	Color	Unit Weight (lbs/ft3)	Strength Type	Cohesion (psf)	Phi (deg)
Embankment Fill		120	Mohr-Coulomb	350	20
Clayey Sand		120	Mohr-Coulomb	400	20
Sandy Clay		120	Mohr-Coulomb	500	20
Clayey Sand Below WT		57.6	Mohr-Coulomb	400	20

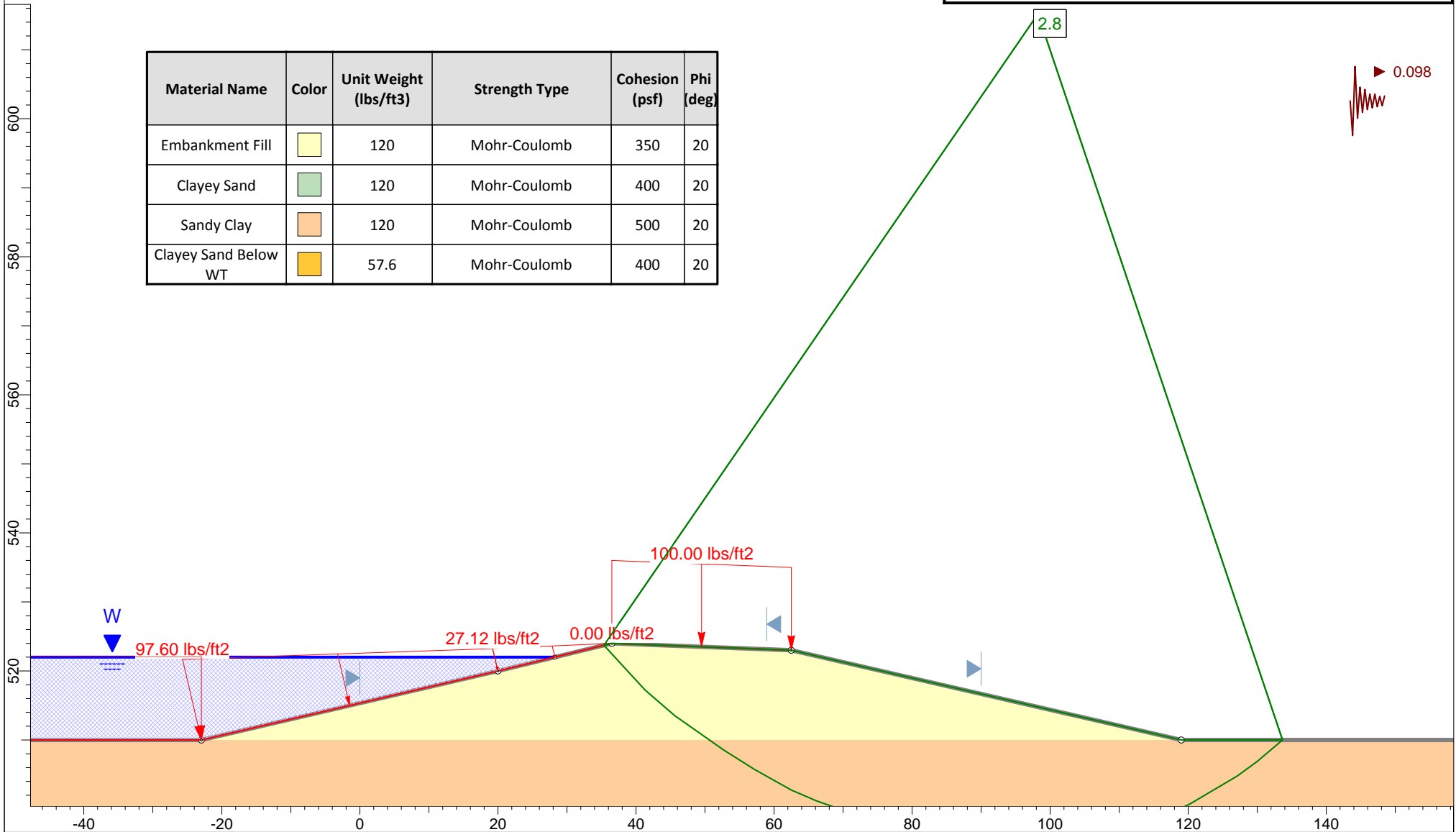

Profile "B" - Steady State
Ash Pond Berms - Spruce/Deely Generation Units

Raba Kistner Consultants, Inc.
ASA12-098-00

Figure D-15a



Global Stability Analysis

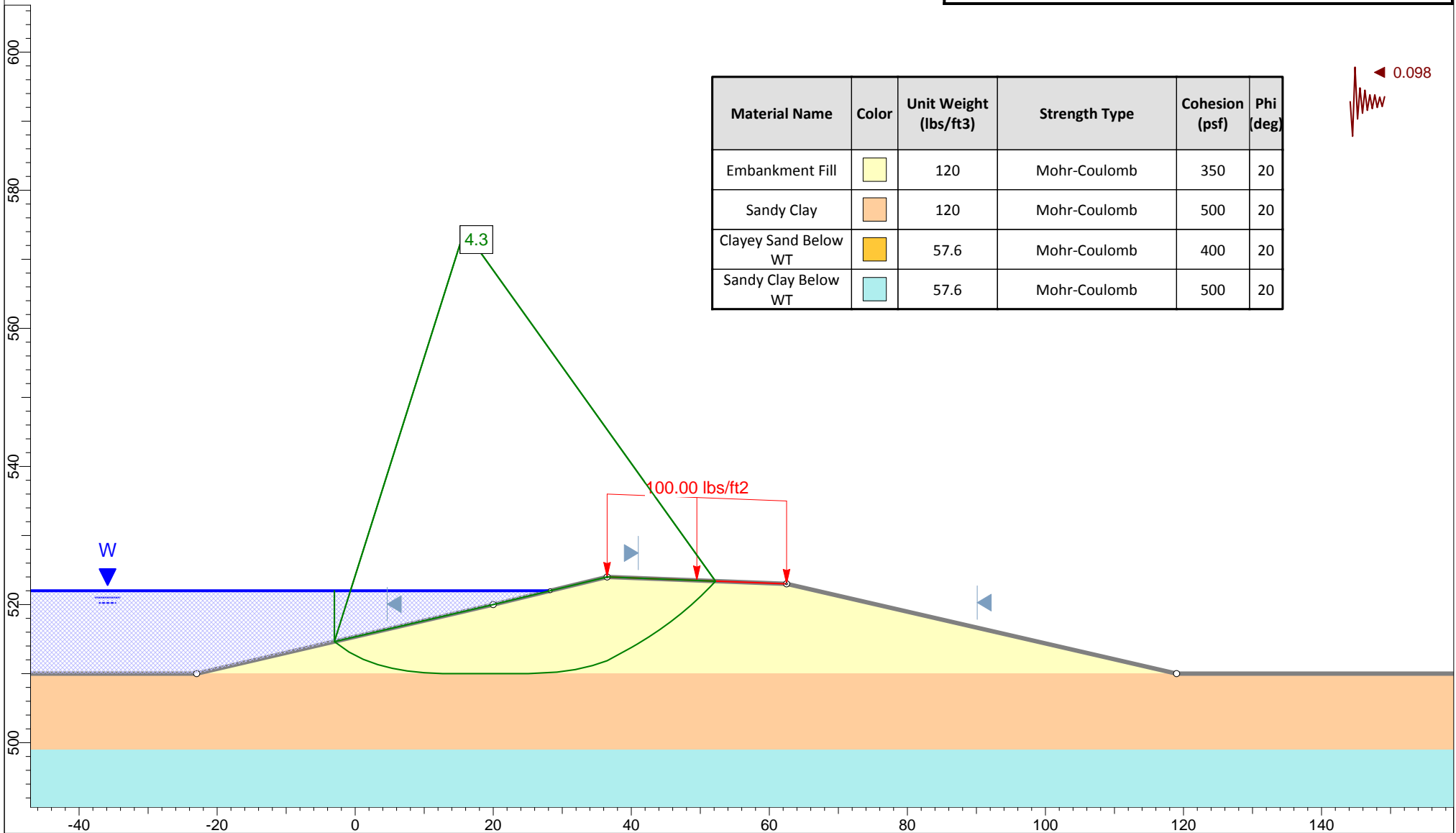

Material Name	Color	Unit Weight (lbs/ft3)	Strength Type	Cohesion (psf)	Phi (deg)
Embankment Fill	Yellow	120	Mohr-Coulomb	350	20
Sandy Clay	Orange	120	Mohr-Coulomb	500	20
Clayey Sand Below WT	Dark Yellow	57.6	Mohr-Coulomb	400	20
Sandy Clay Below WT	Light Blue	57.6	Mohr-Coulomb	500	20



Profile "B" - Steady State
Ash Pond Berms - Spruce/Deely Generation Units

Raba Kistner Consultants, Inc.
ASA12-098-00

Figure D-15b



Global Stability Analysis

Material Name	Color	Unit Weight (lbs/ft ³)	Strength Type	Cohesion (psf)	Phi (deg)
Embankment Fill		120	Mohr-Coulomb	350	20
Clayey Sand		120	Mohr-Coulomb	400	20
Clayey Sand Below WT		57.6	Mohr-Coulomb	400	20

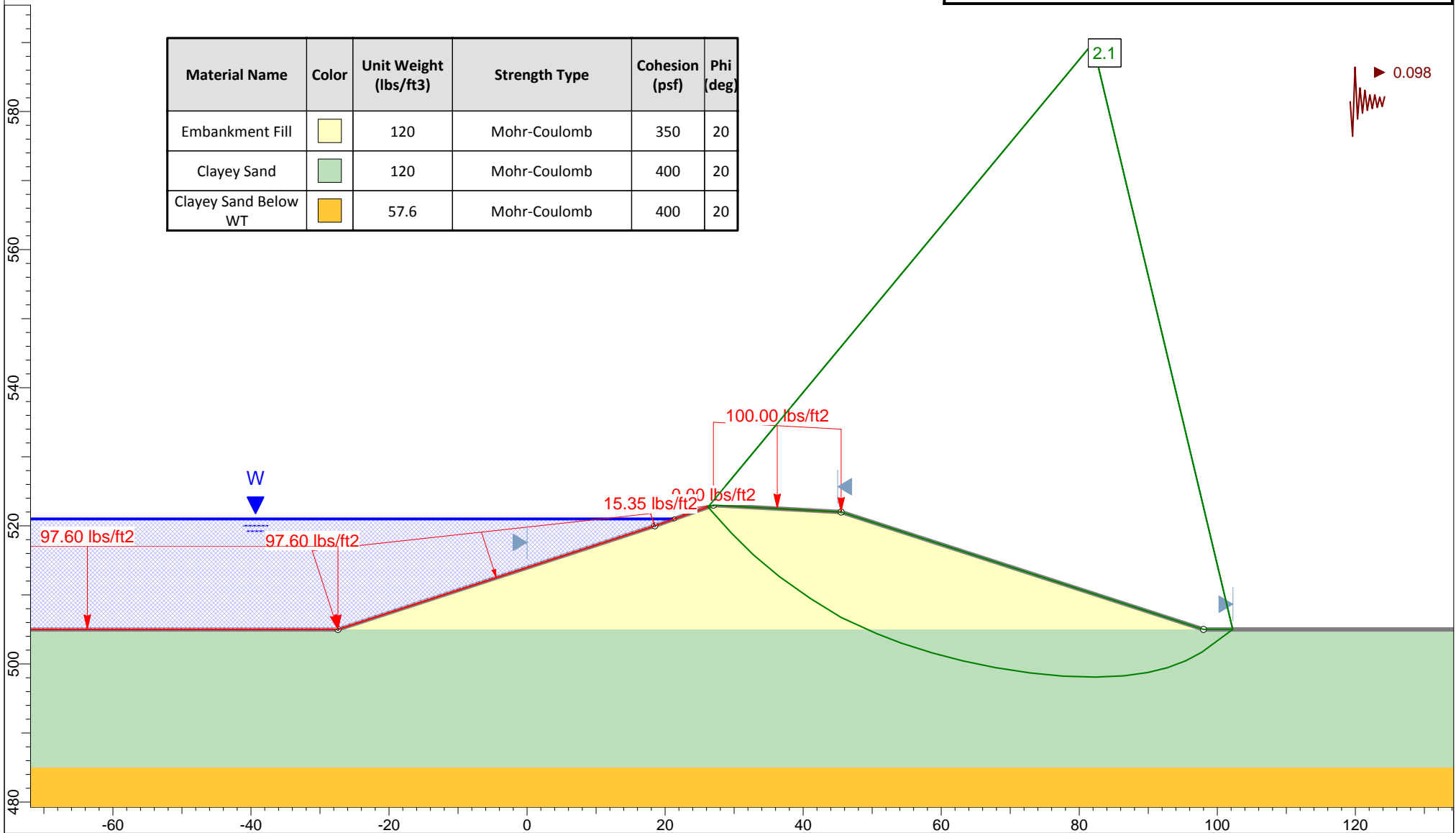

Profile "C" - Steady State
Ash Pond Berms - Spruce/Deely Generation Units

Raba Kistner Consultants, Inc.
ASA12-098-00

Figure D-16a



Global Stability Analysis

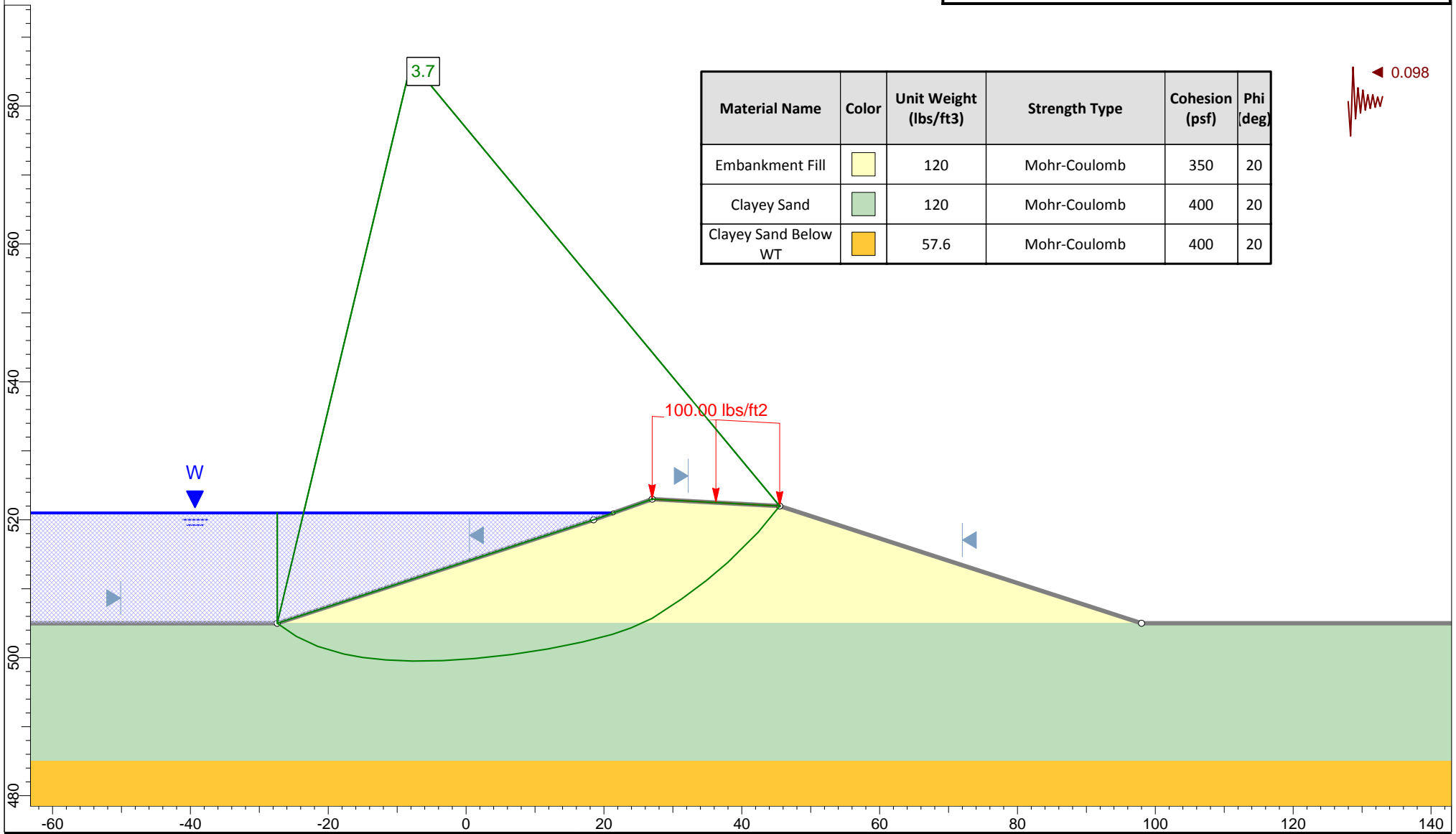

Material Name	Color	Unit Weight (lbs/ft3)	Strength Type	Cohesion (psf)	Phi (deg)
Embankment Fill	Yellow	120	Mohr-Coulomb	350	20
Clayey Sand	Green	120	Mohr-Coulomb	400	20
Clayey Sand Below WT	Orange	57.6	Mohr-Coulomb	400	20

0.098





Profile "C" - Steady State
Ash Pond Berms - Spruce/Deely Generation Units

Raba Kistner Consultants, Inc.
ASA12-098-00

Figure D-16b



Global Stability Analysis

Material Name	Color	Unit Weight (lbs/ft3)	Strength Type	Cohesion (psf)	Phi (deg)
Embankment Fill		120	Mohr-Coulomb	350	20
Clayey Sand		120	Mohr-Coulomb	400	20
Sandy Clay		120	Mohr-Coulomb	500	20
Clayey Sand Below WT		57.6	Mohr-Coulomb	400	20

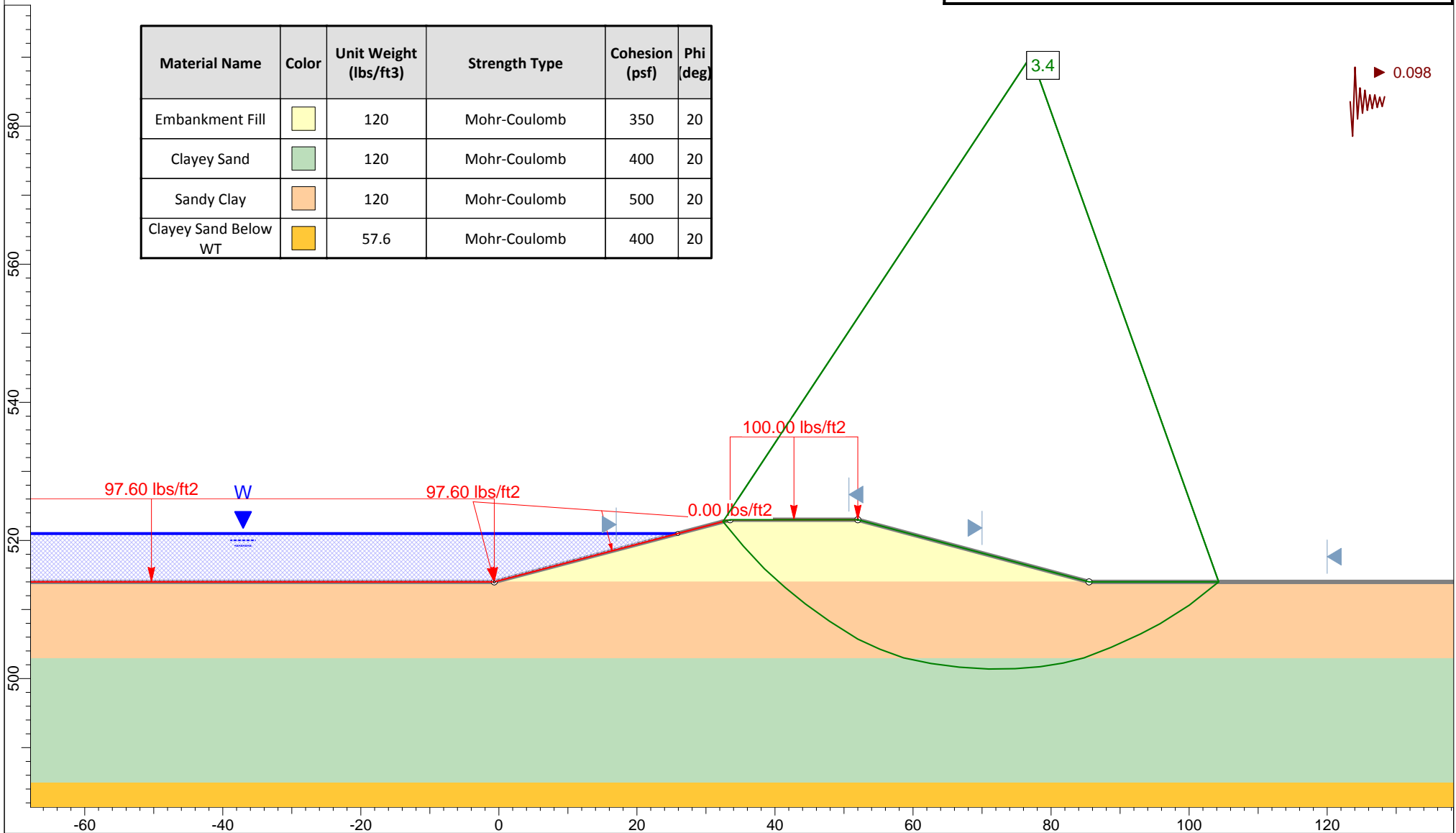

Profile "D" - Steady State
Ash Pond Berms - Spruce/Deely Generation Units

Raba Kistner Consultants, Inc.
ASA12-098-00

Figure D-17a



Global Stability Analysis

Material Name	Color	Unit Weight (lbs/ft3)	Strength Type	Cohesion (psf)	Phi (deg)
Embankment Fill	Yellow	120	Mohr-Coulomb	350	20
Clayey Sand	Light Green	120	Mohr-Coulomb	400	20
Sandy Clay	Light Orange	120	Mohr-Coulomb	500	20
Clayey Sand Below WT	Yellow-Orange	57.6	Mohr-Coulomb	400	20

◀ 0.098

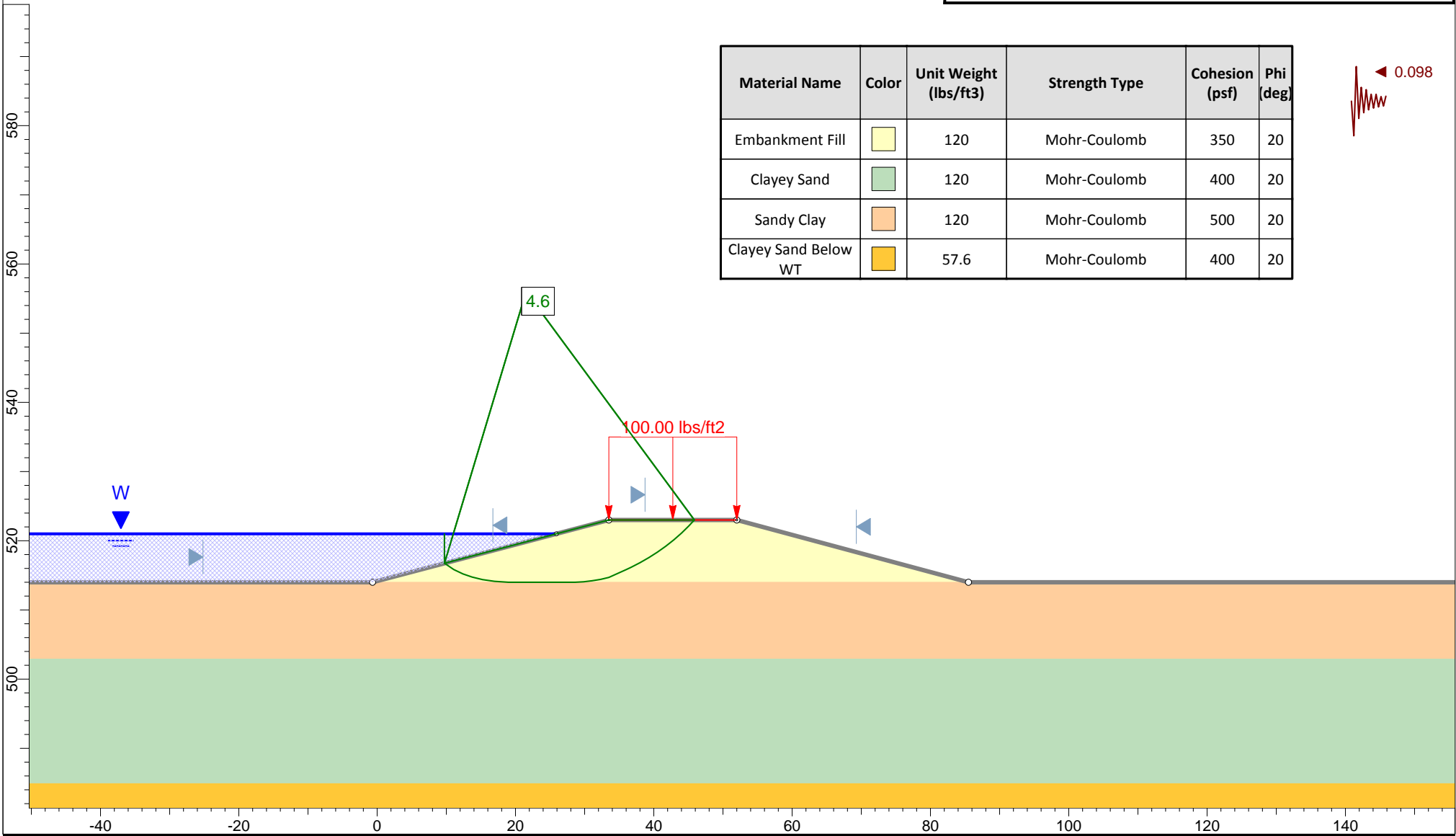



Profile "D" - Steady State
Ash Pond Berms - Spruce/Deely Generation Units

Raba Kistner Consultants, Inc.
ASA12-098-00

Figure D-17b



Global Stability Analysis

Material Name	Color	Unit Weight (lbs/ft ³)	Strength Type	Cohesion (psf)	Phi (deg)
Embankment Soil		120	Mohr-Coulomb	350	20
Sandy Clay		120	Mohr-Coulomb	500	20
Clayey Sand Below WT		57.6	Mohr-Coulomb	400	20

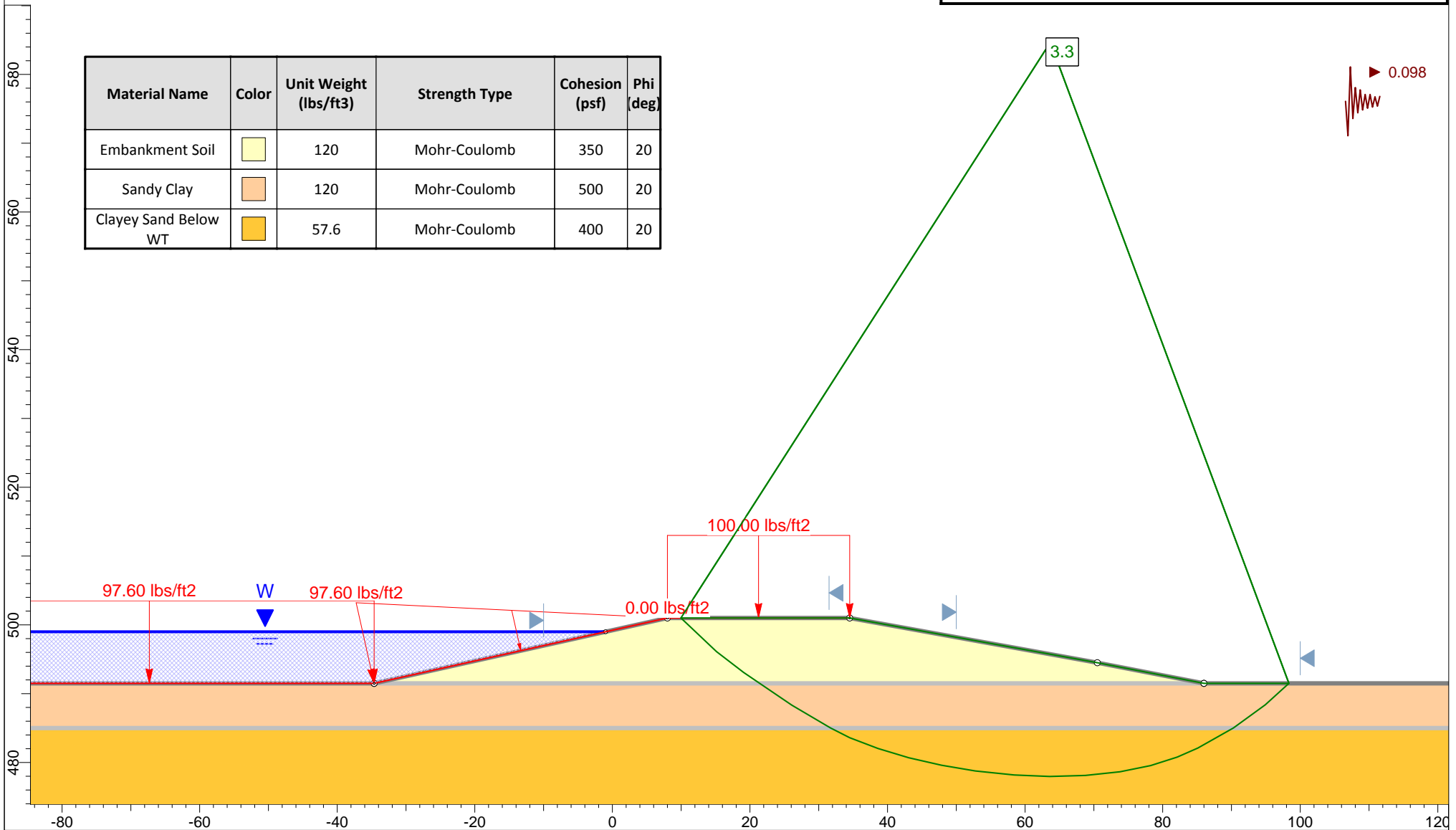

Profile "E" - Steady State
Ash Pond Berms - Spruce/Deely Generation Units

Raba Kistner Consultants, Inc.
ASA12-098-00

Figure D-18a



Global Stability Analysis

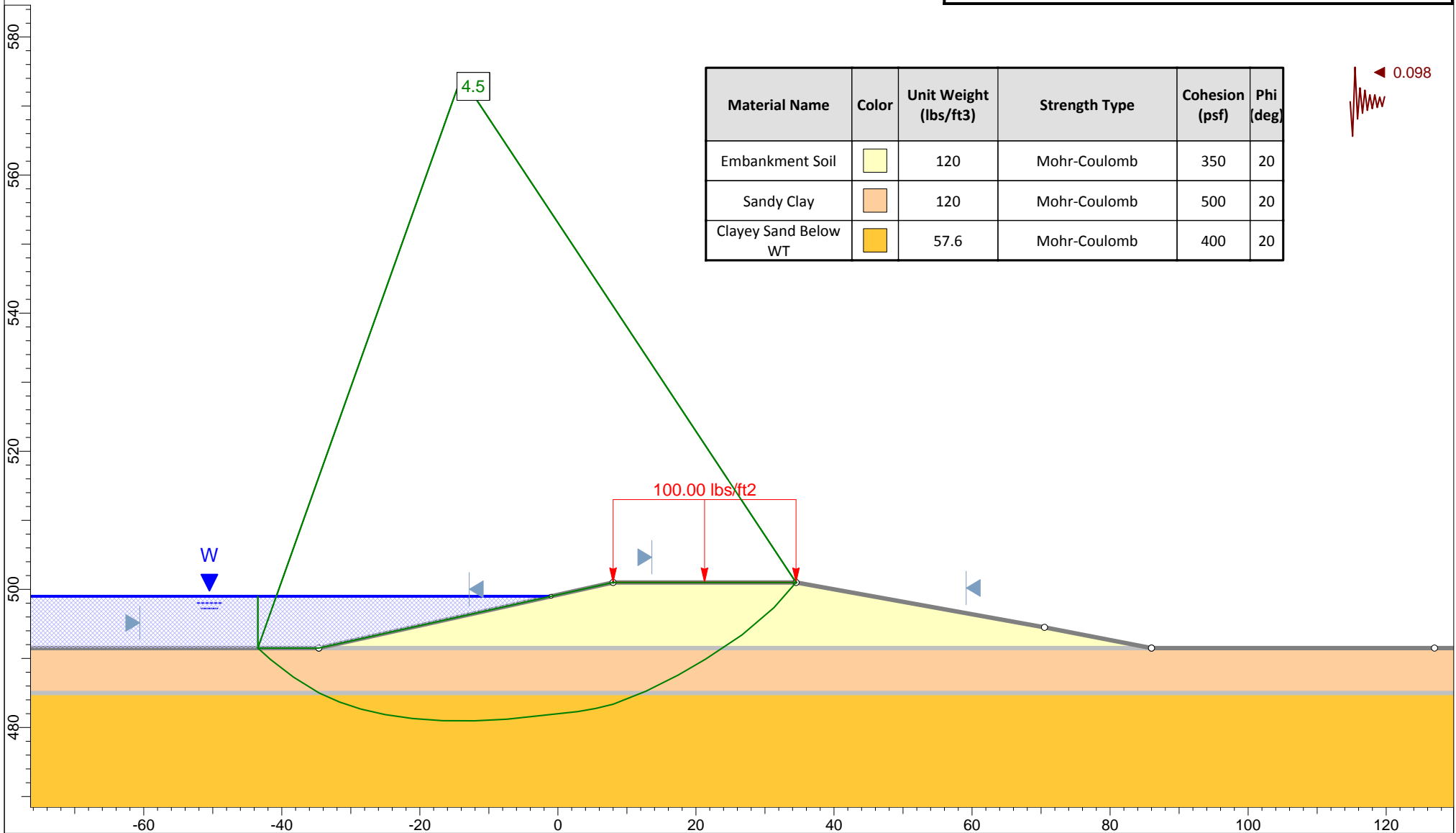





Profile "E" - Steady State
Ash Pond Berms - Spruce/Deely Generation Units

Raba Kistner Consultants, Inc.
ASA12-098-00

Figure D-18b



Global Stability Analysis

Material Name	Color	Unit Weight (lbs/ft ³)	Strength Type	Cohesion (psf)	Phi (deg)
Embankment Fill		120	Mohr-Coulomb	350	20
Clayey Sand		120	Mohr-Coulomb	400	20
Clayey Sand Below WT		57.6	Mohr-Coulomb	400	20
Sandy Clay Below WT		57.6	Mohr-Coulomb	500	20

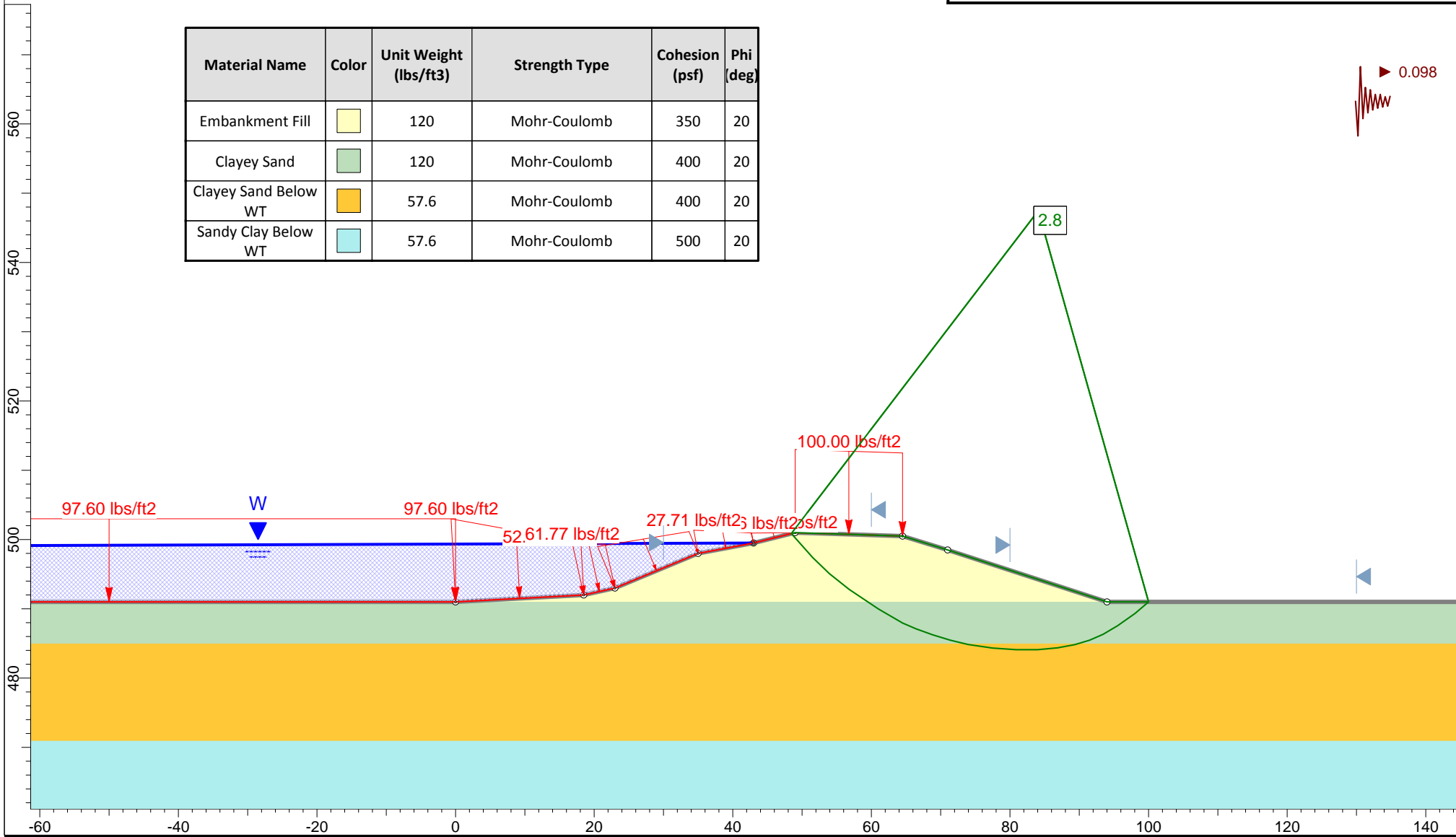





Profile "F" - Steady State
Ash Pond Berms - Spruce/Deely Generation Units

Raba Kistner Consultants, Inc.
ASA12-098-00

Figure D-19a



Global Stability Analysis

Material Name	Color	Unit Weight (lbs/ft ³)	Strength Type	Cohesion (psf)	Phi (deg)
Embankment Fill		120	Mohr-Coulomb	350	20
Clayey Sand		120	Mohr-Coulomb	400	20
Clayey Sand Below WT		57.6	Mohr-Coulomb	400	20
Sandy Clay Below WT		57.6	Mohr-Coulomb	500	20

 0.098

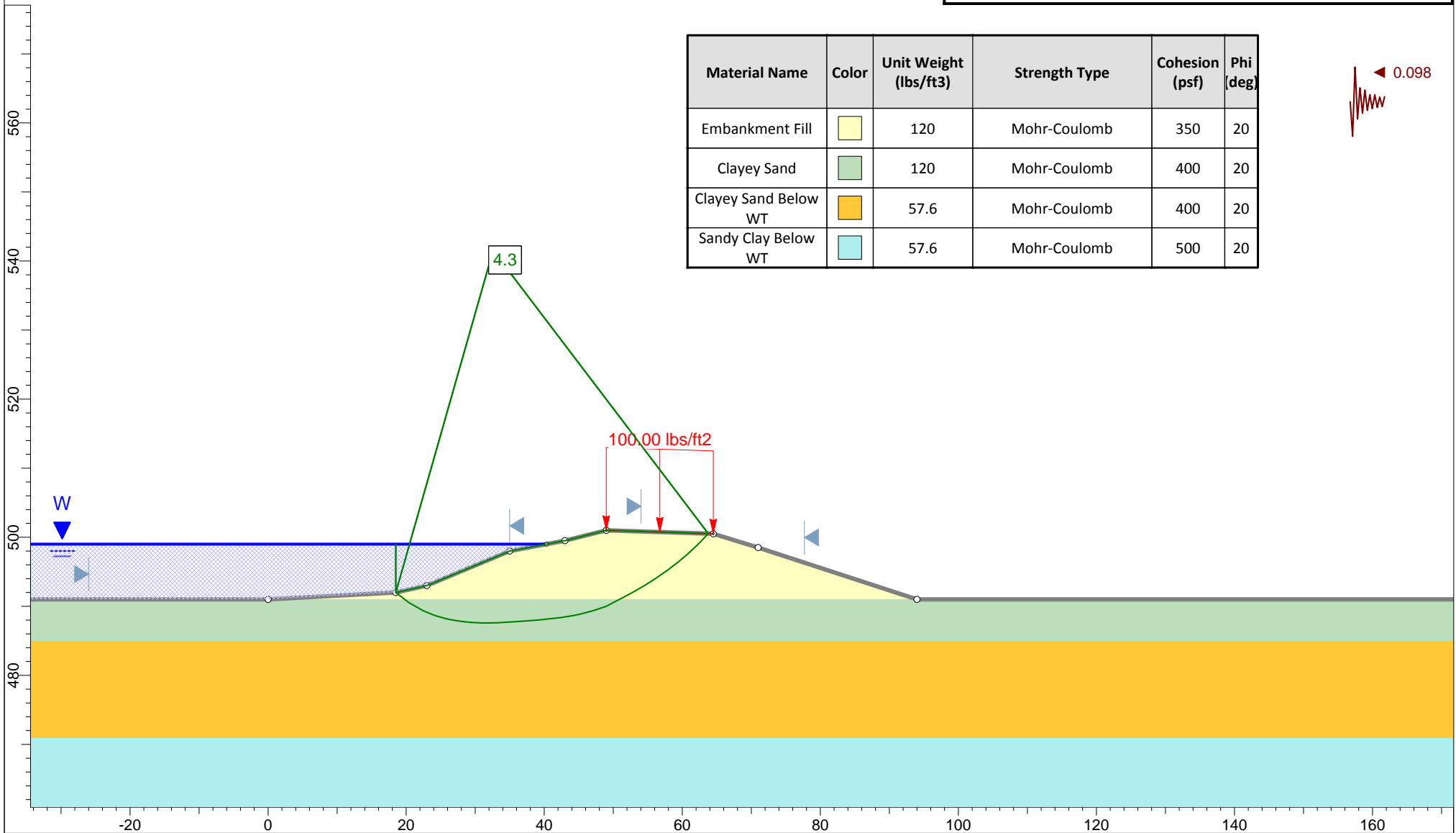



Profile "F" - Steady State
Ash Pond Berms - Spruce/Deely Generation Units

Raba Kistner Consultants, Inc.
ASA12-098-00

Figure D-19b



Global Stability Analysis

Material Name	Color	Unit Weight (lbs/ft ³)	Strength Type	Cohesion (psf)	Phi (deg)
Embankment Fill		120	Mohr-Coulomb	350	20
Clayey Sand Below WT		57.6	Mohr-Coulomb	400	20
Sandy Clay Below WT		57.6	Mohr-Coulomb	500	20

 0.098

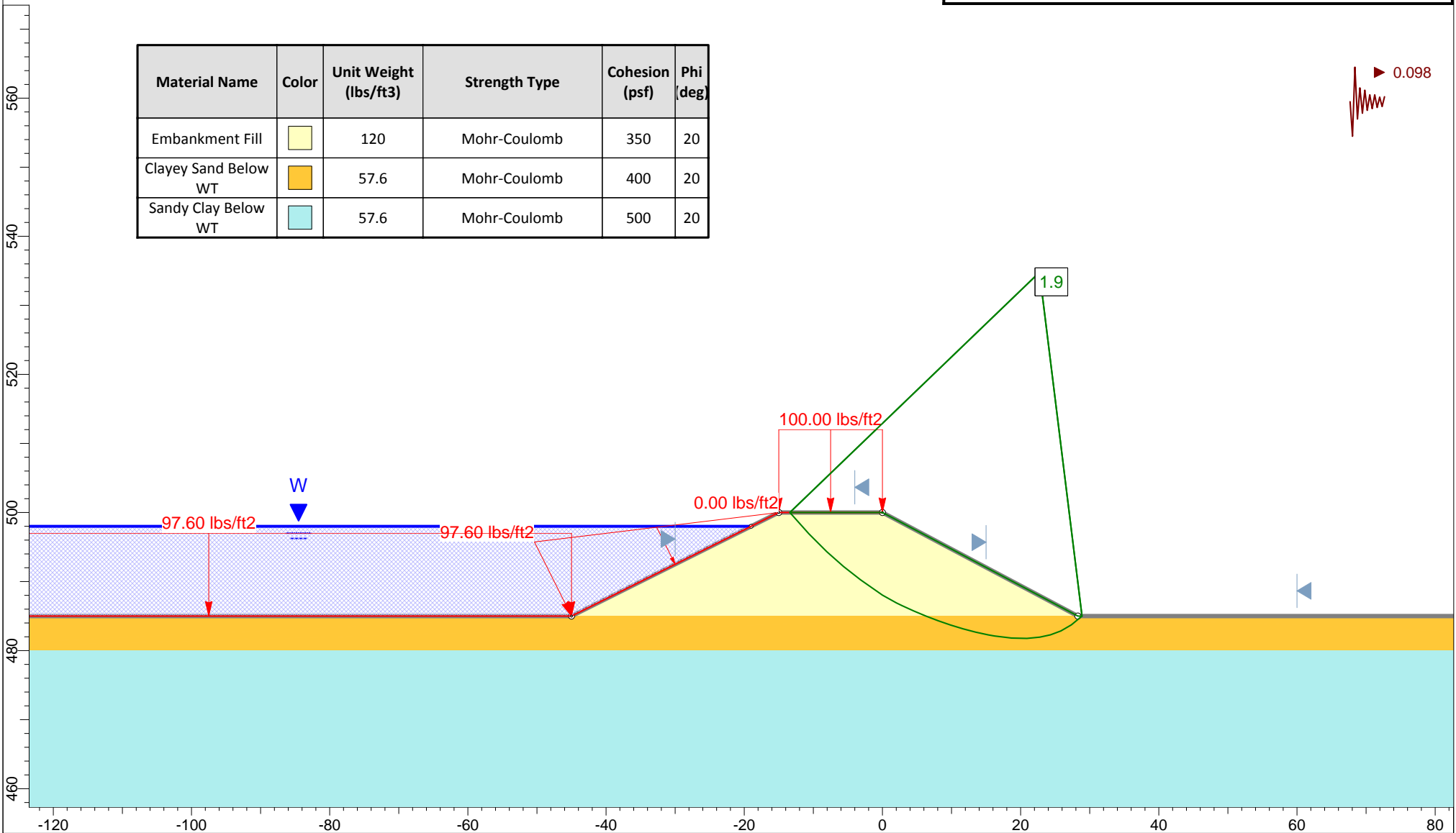

Profile "G" - Steady State
Ash Pond Berms - Spruce/Deely Generation Units

Raba Kistner Consultants, Inc.
ASA12-098-00

Figure D-20a



Global Stability Analysis

Material Name	Color	Unit Weight (lbs/ft ³)	Strength Type	Cohesion (psf)	Phi (deg)
Embankment Fill	Yellow	120	Mohr-Coulomb	350	20
Clayey Sand Below WT	Orange	57.6	Mohr-Coulomb	400	20
Sandy Clay Below WT	Light Blue	57.6	Mohr-Coulomb	500	20

◀ 0.098

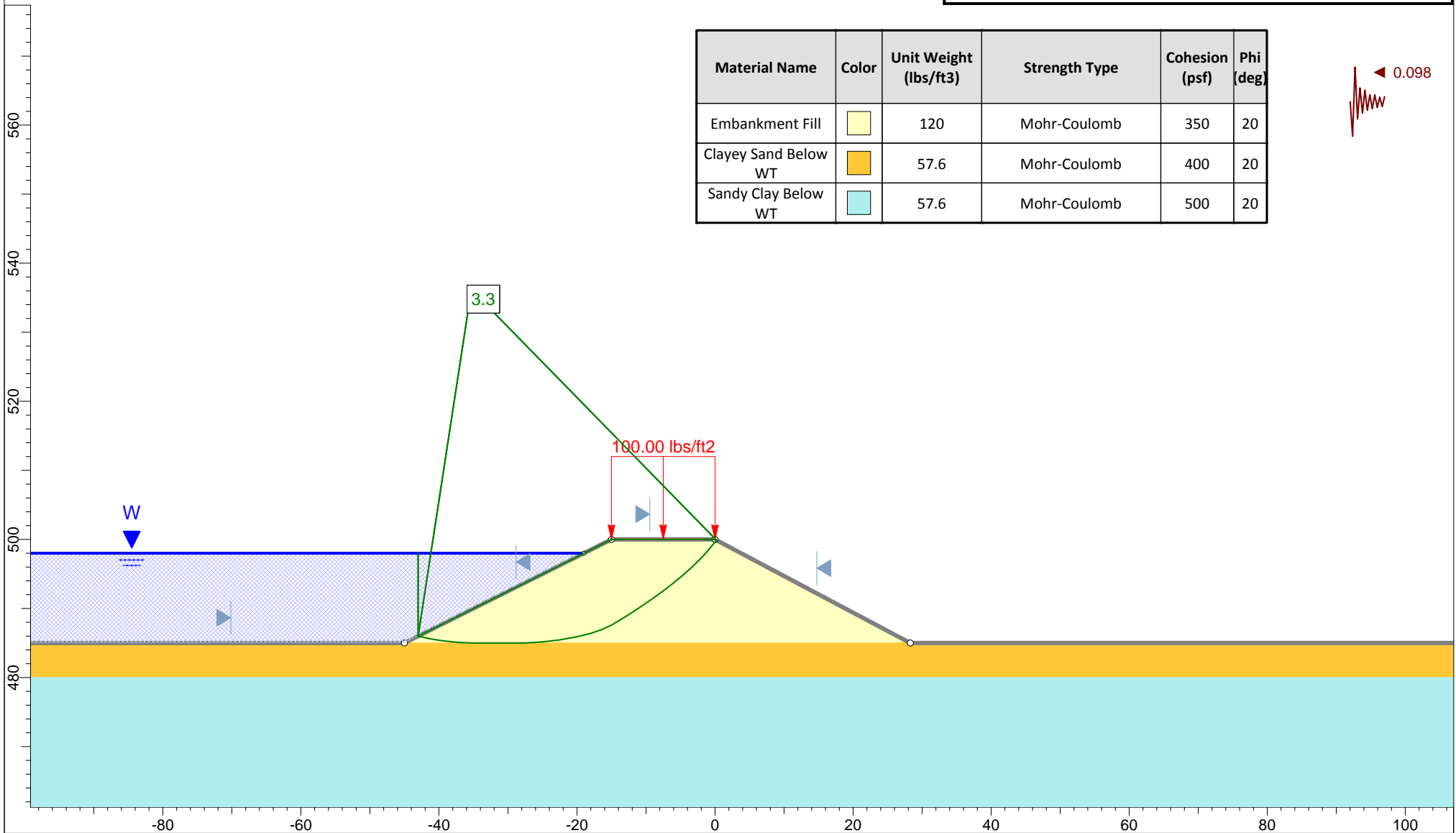





Profile "G" - Steady State
Ash Pond Berms - Spruce/Deely Generation Units

Raba Kistner Consultants, Inc.
ASA12-098-00

Figure D-20b



Global Stability Analysis

Material Name	Color	Unit Weight (lbs/ft ³)	Strength Type	Cohesion (psf)	Phi (deg)
Embankment Fill		120	Mohr-Coulomb	350	20
Sandy Clay		120	Mohr-Coulomb	500	20
Clayey Sand Below WT		57.6	Mohr-Coulomb	400	20
Sandy Clay Below WT		57.6	Mohr-Coulomb	500	20

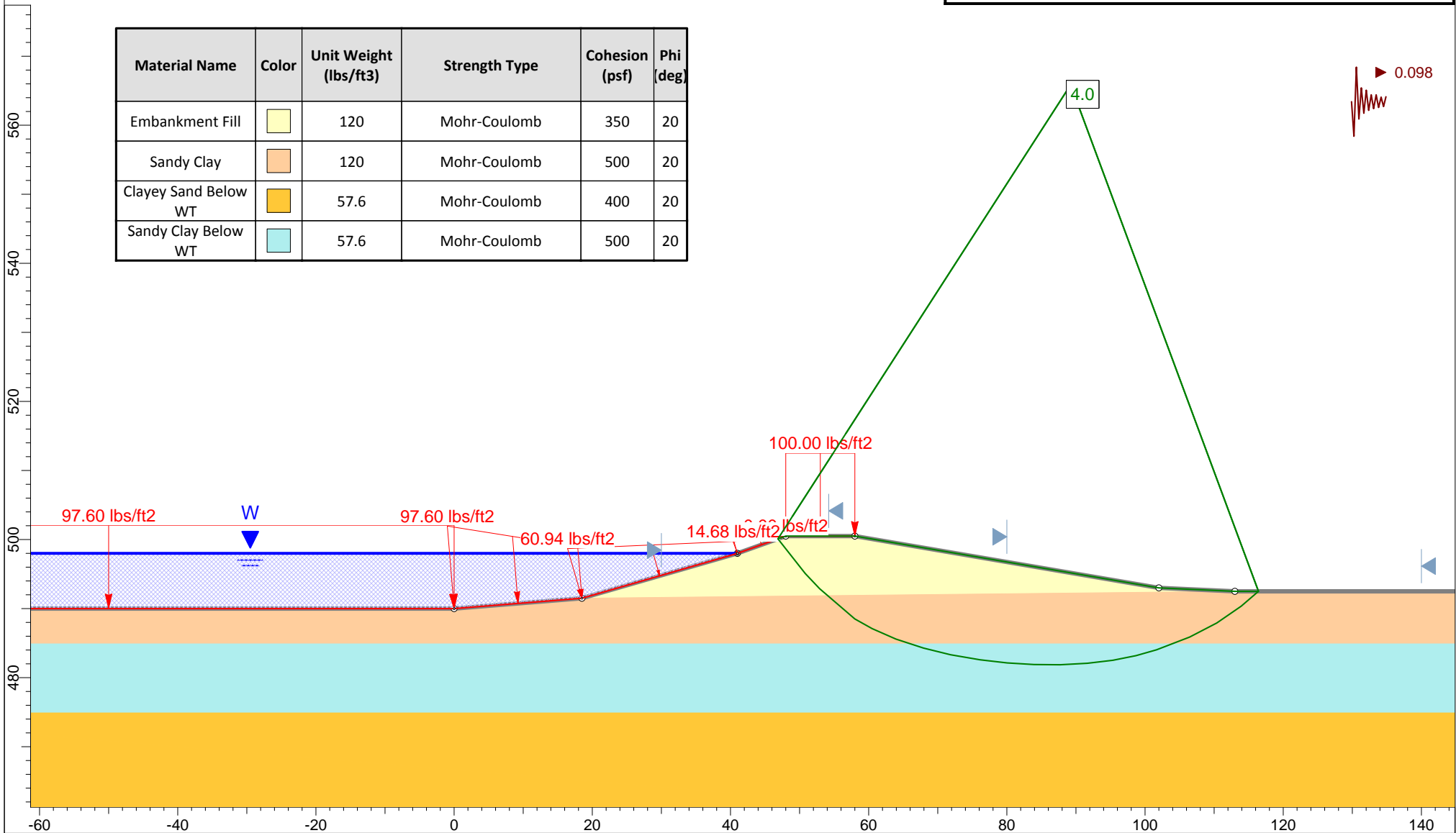





Profile "H" - Steady State
Ash Pond Berms - Spruce/Deely Generation Units

Raba Kistner Consultants, Inc.
ASA12-098-00

Figure D-21a



Global Stability Analysis

Material Name	Color	Unit Weight (lbs/ft ³)	Strength Type	Cohesion (psf)	Phi (deg)
Embankment Fill		120	Mohr-Coulomb	350	20
Sandy Clay		120	Mohr-Coulomb	500	20
Clayey Sand Below WT		57.6	Mohr-Coulomb	400	20
Sandy Clay Below WT		57.6	Mohr-Coulomb	500	20

 0.098

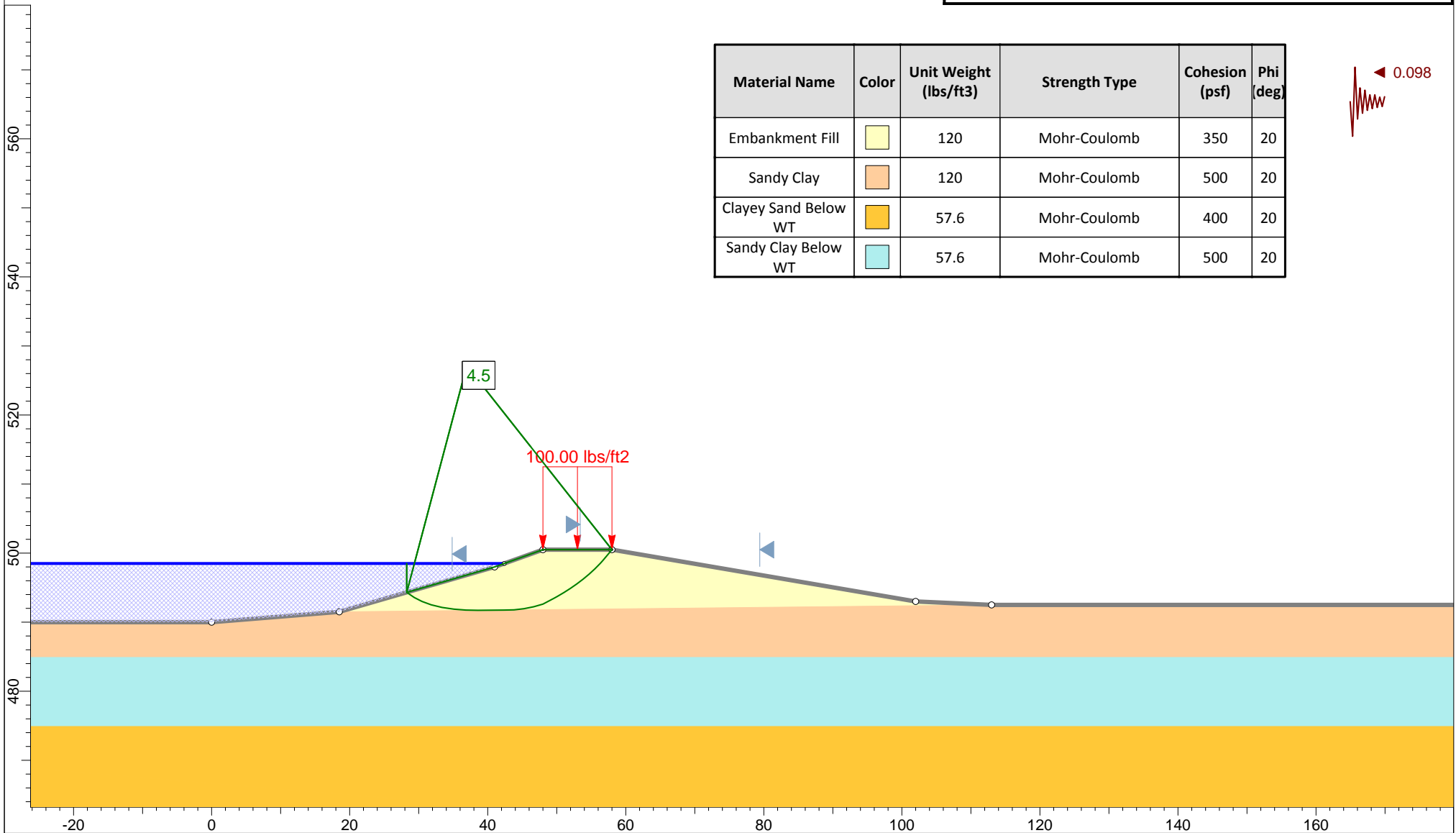





Profile "H" - Steady State
Ash Pond Berms - Spruce/Deely Generation Units

Raba Kistner Consultants, Inc.
ASA12-098-00

Figure D-21b



Global Stability Analysis

Material Name	Color	Unit Weight (lbs/ft ³)	Strength Type	Cohesion (psf)	Phi (deg)
Embankment Fill		120	Mohr-Coulomb	350	20
Sandy Clay		120	Mohr-Coulomb	500	20
Clayey Sand Below WT		57.6	Mohr-Coulomb	400	20
Sandy Clay Below WT		57.6	Mohr-Coulomb	500	20

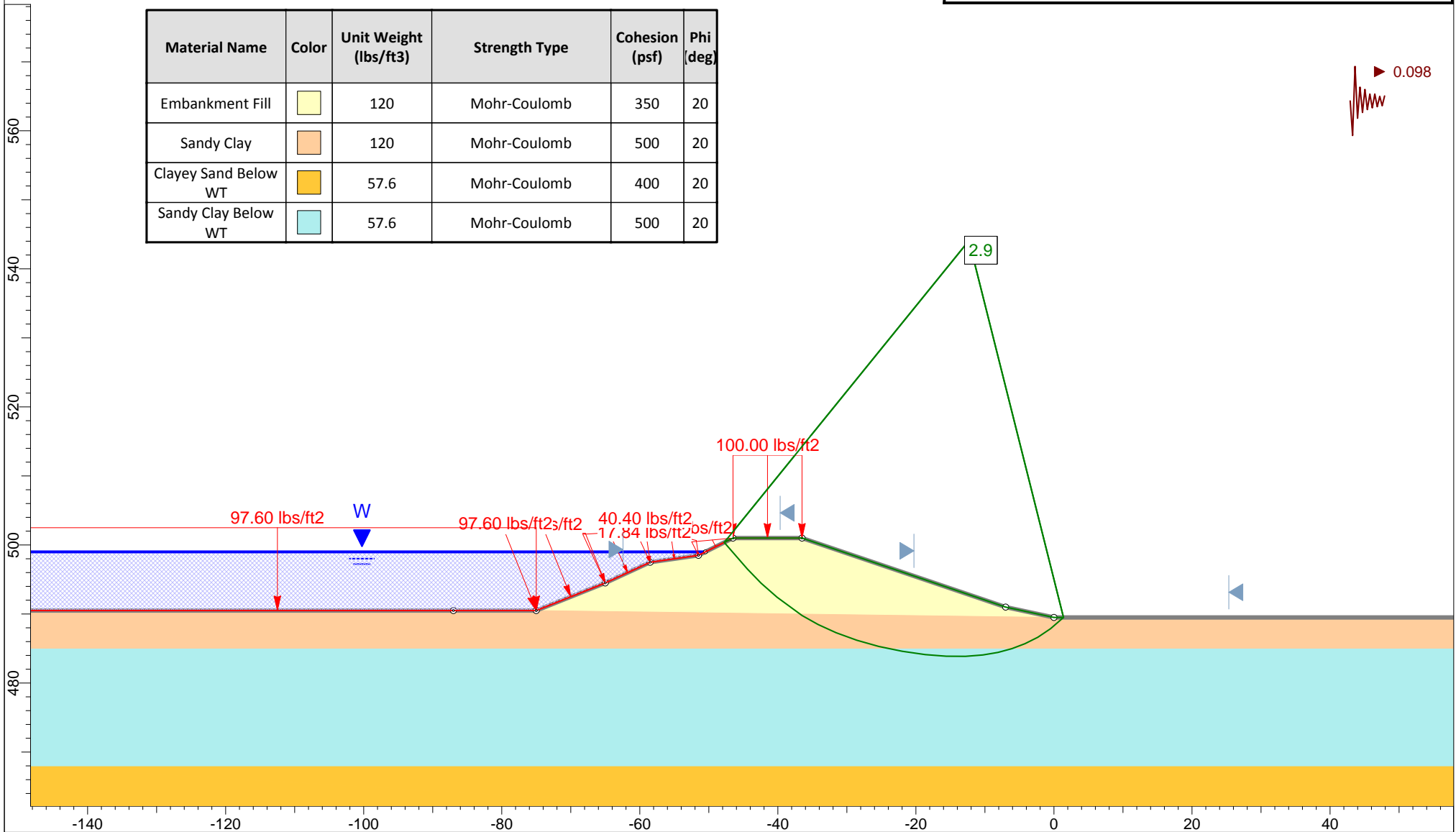

Profile "I" - Steady State
Ash Pond Berms - Spruce/Deely Generation Units

Raba Kistner Consultants, Inc.
ASA12-098-00

Figure D-22a



Global Stability Analysis

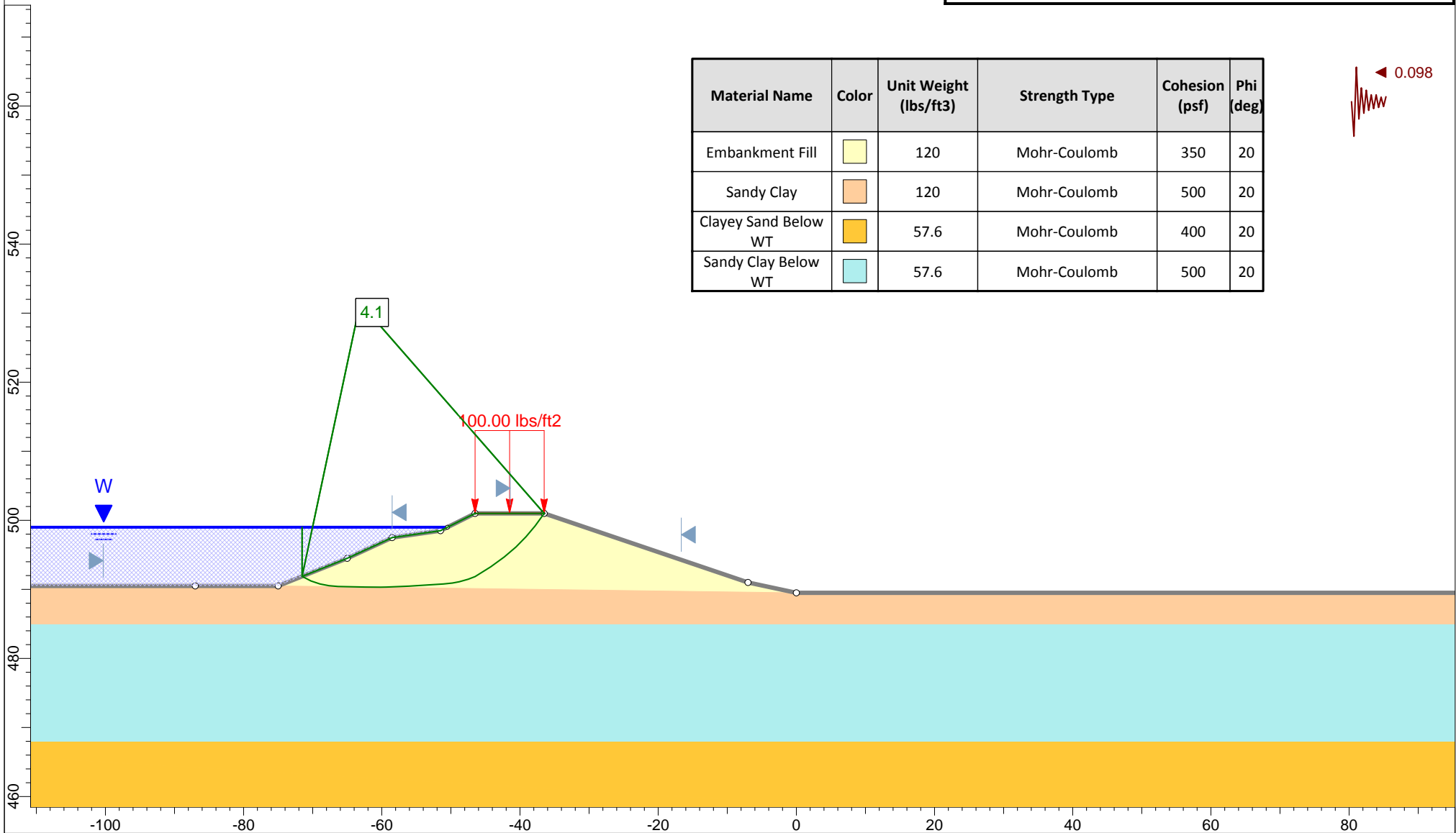



Material Name	Color	Unit Weight (lbs/ft ³)	Strength Type	Cohesion (psf)	Phi (deg)
Embankment Fill	Yellow	120	Mohr-Coulomb	350	20
Sandy Clay	Orange	120	Mohr-Coulomb	500	20
Clayey Sand Below WT	Yellow	57.6	Mohr-Coulomb	400	20
Sandy Clay Below WT	Cyan	57.6	Mohr-Coulomb	500	20

Profile "I" - Steady State
Ash Pond Berms - Spruce/Deely Generation Units

Raba Kistner Consultants, Inc.
ASA12-098-00

Figure D-22b

Global Stability Analysis

Material Name	Color	Unit Weight (lbs/ft ³)	Strength Type	Cohesion (psf)	Phi (deg)
Embankment Fill		120	Mohr-Coulomb	350	20
Clayey Sand		120	Mohr-Coulomb	400	20
Clayey Sand Below WT		57.6	Mohr-Coulomb	400	20

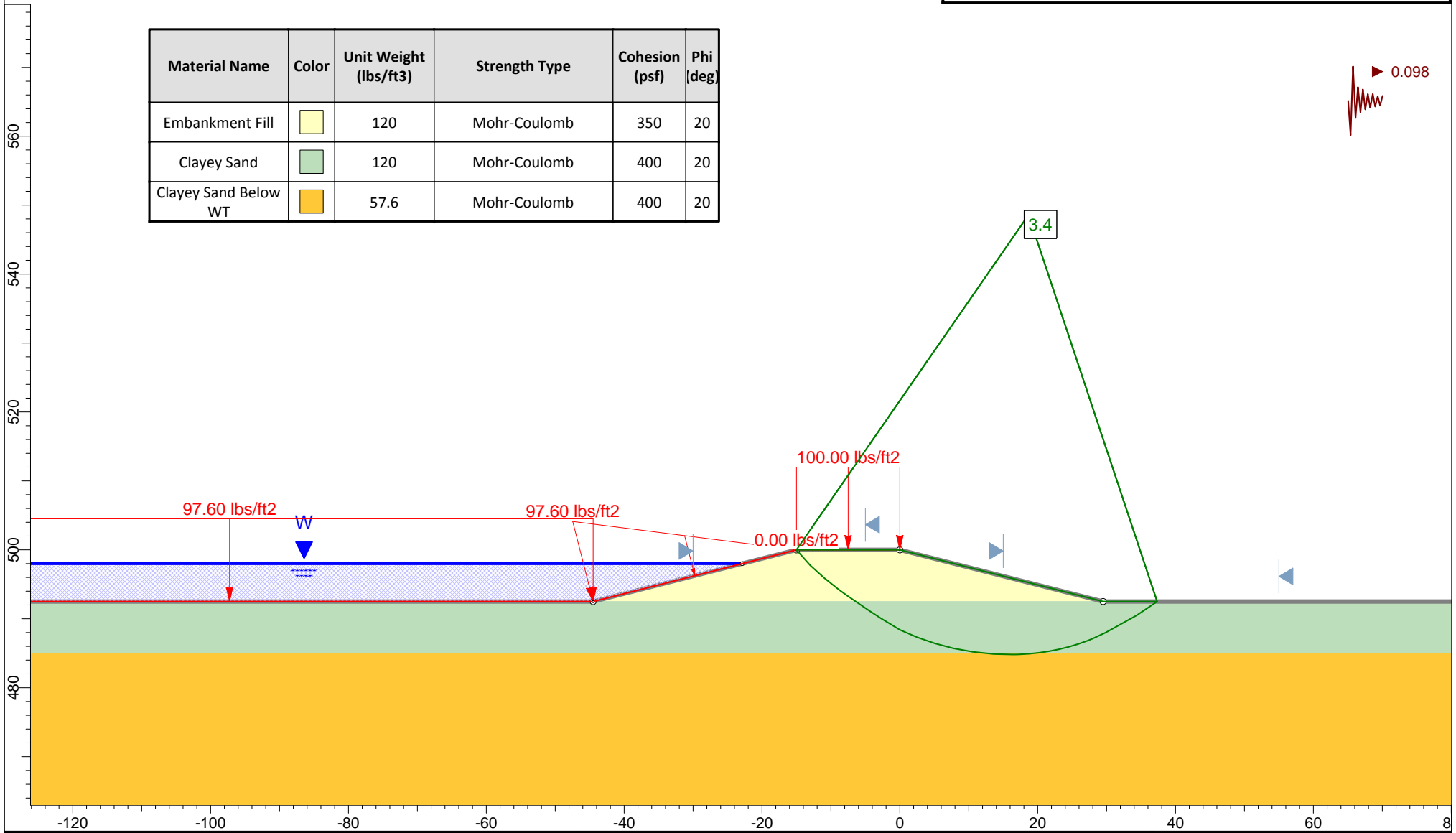



Profile "J" - Steady State
Ash Pond Berms - Spruce/Deely Generation Units

Raba Kistner Consultants, Inc.
ASA12-098-00

Figure D-23a



Global Stability Analysis

Material Name	Color	Unit Weight (lbs/ft ³)	Strength Type	Cohesion (psf)	Phi (deg)
Embankment Fill		120	Mohr-Coulomb	350	20
Clayey Sand		120	Mohr-Coulomb	400	20
Clayey Sand Below WT		57.6	Mohr-Coulomb	400	20

 0.098

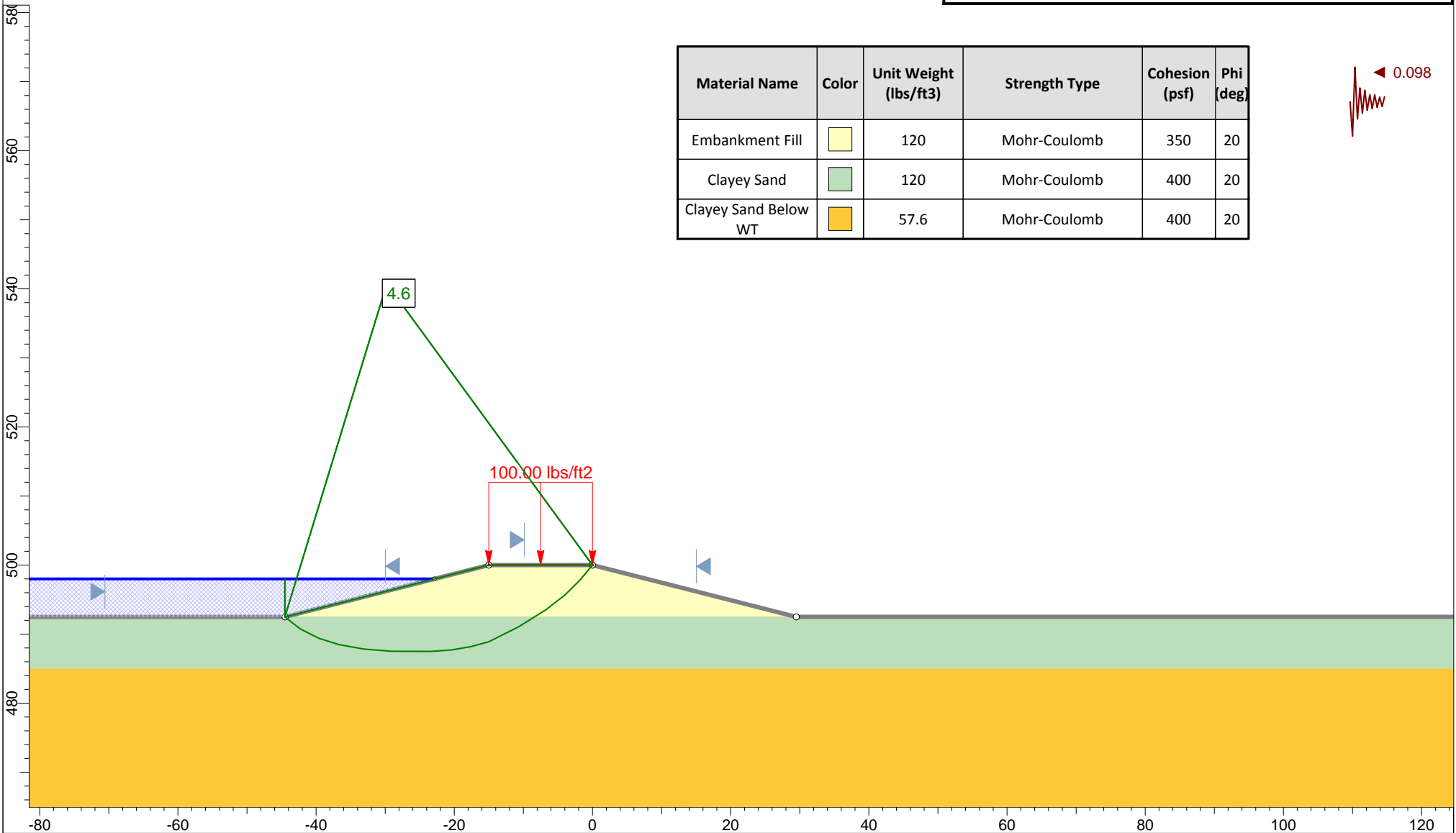



Profile "J" - Steady State
Ash Pond Berms - Spruce/Deely Generation Units

Raba Kistner Consultants, Inc.
ASA12-098-00

Figure D-23b



Global Stability Analysis

Material Name	Color	Unit Weight (lbs/ft ³)	Strength Type	Cohesion (psf)	Phi (deg)
Embankment Fill		120	Mohr-Coulomb	350	20
Sandy Clay		120	Mohr-Coulomb	500	20
Sandy Clay Below WT		57.6	Mohr-Coulomb	500	20

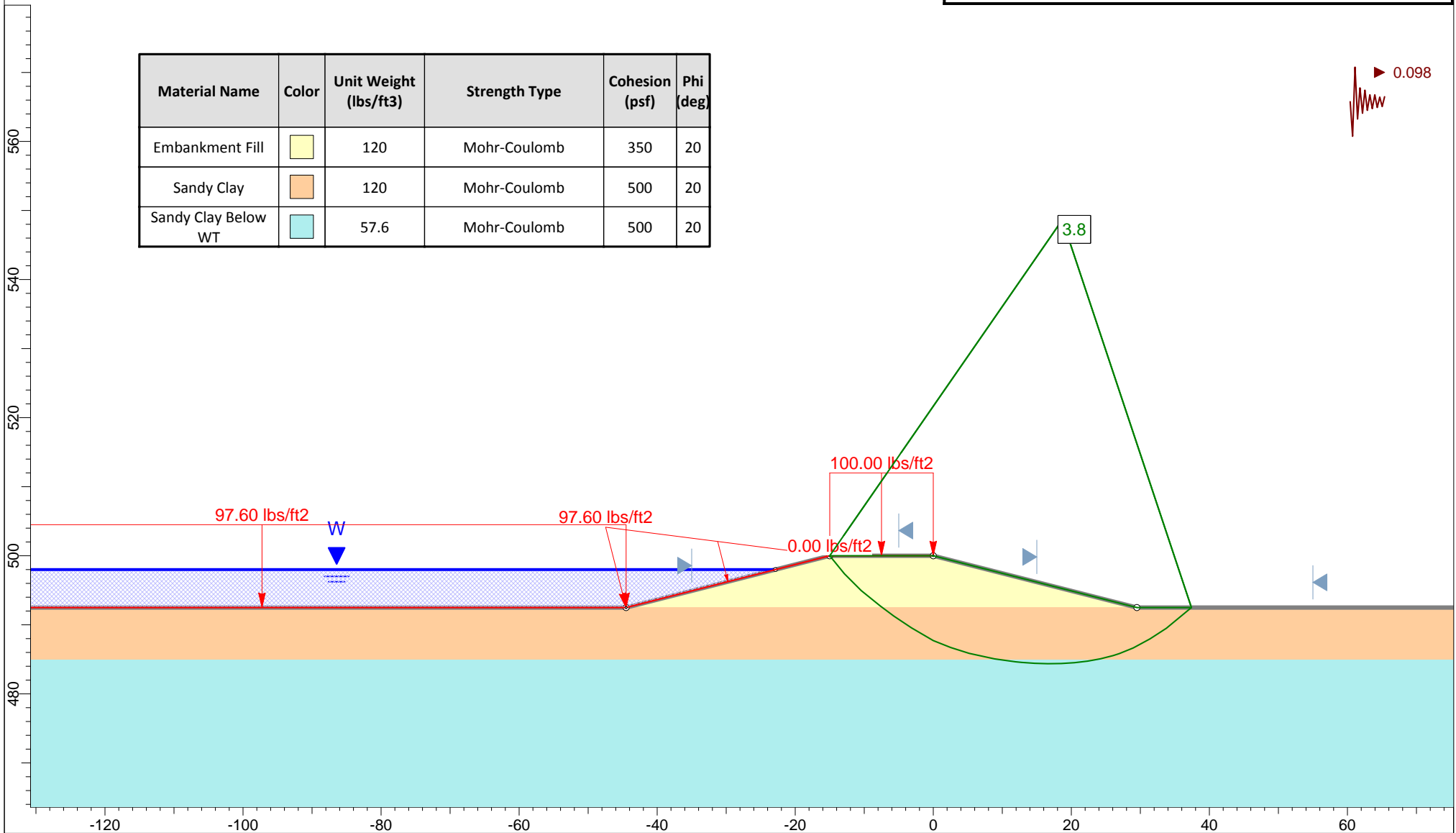



Profile "K" - Steady State
Ash Pond Berms - Spruce/Deely Generation Units

Raba Kistner Consultants, Inc.
ASA12-098-00

Figure D-24a



Global Stability Analysis

Material Name	Color	Unit Weight (lbs/ft ³)	Strength Type	Cohesion (psf)	Phi (deg)
Embankment Fill		120	Mohr-Coulomb	350	20
Sandy Clay		120	Mohr-Coulomb	500	20
Sandy Clay Below WT		57.6	Mohr-Coulomb	500	20

 0.098

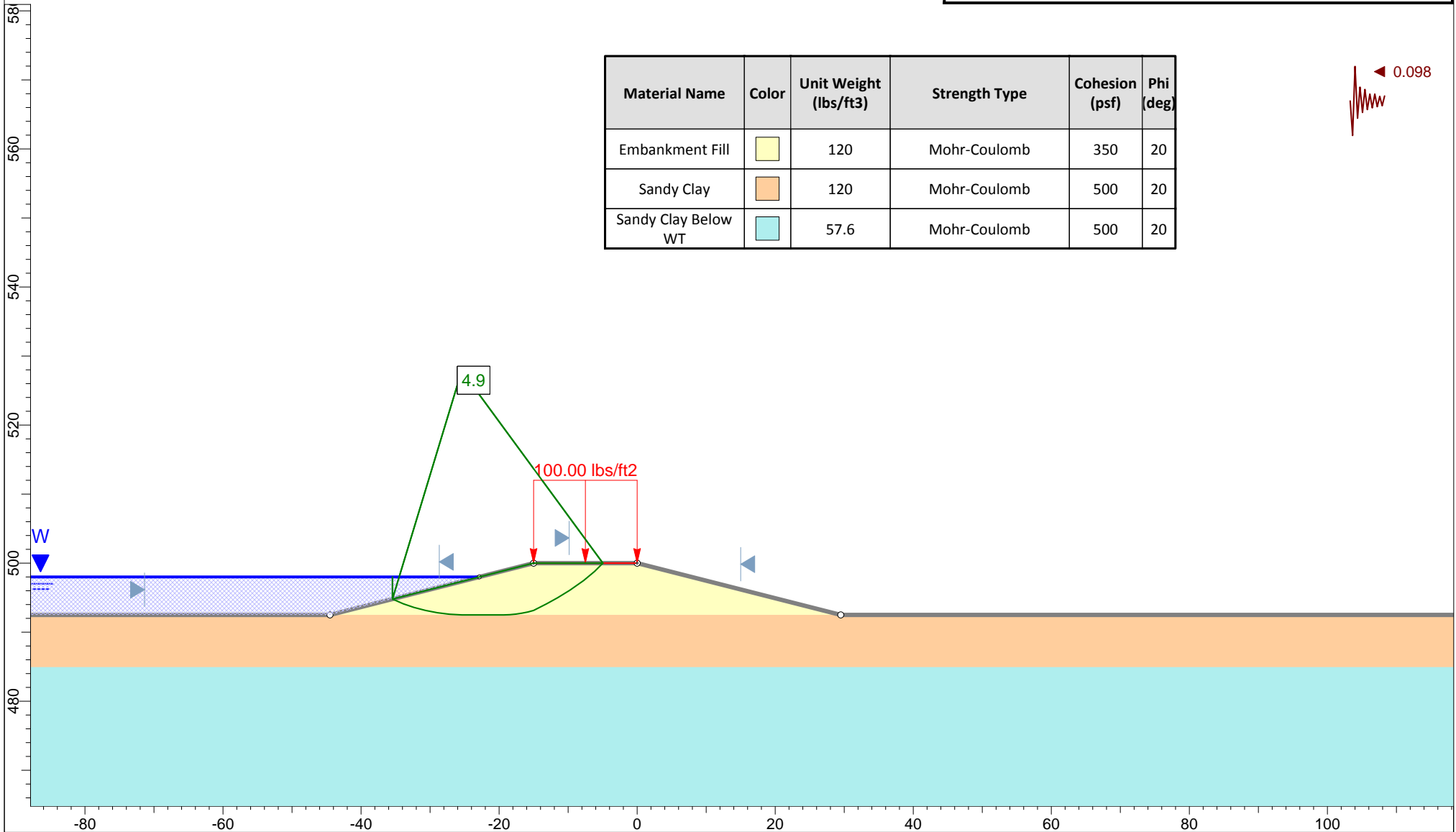





Profile "K" - Steady State
Ash Pond Berms - Spruce/Deely Generation Units

Raba Kistner Consultants, Inc.
ASA12-098-00

Figure D-24b



Global Stability Analysis

Material Name	Color	Unit Weight (lbs/ft ³)	Strength Type	Cohesion (psf)	Phi (deg)
Embankment Fill		120	Mohr-Coulomb	350	20
Clayey Sand		120	Mohr-Coulomb	400	20
Clayey Sand Below WT		57.6	Mohr-Coulomb	400	20
Sandy Clay Below WT		57.6	Mohr-Coulomb	500	20

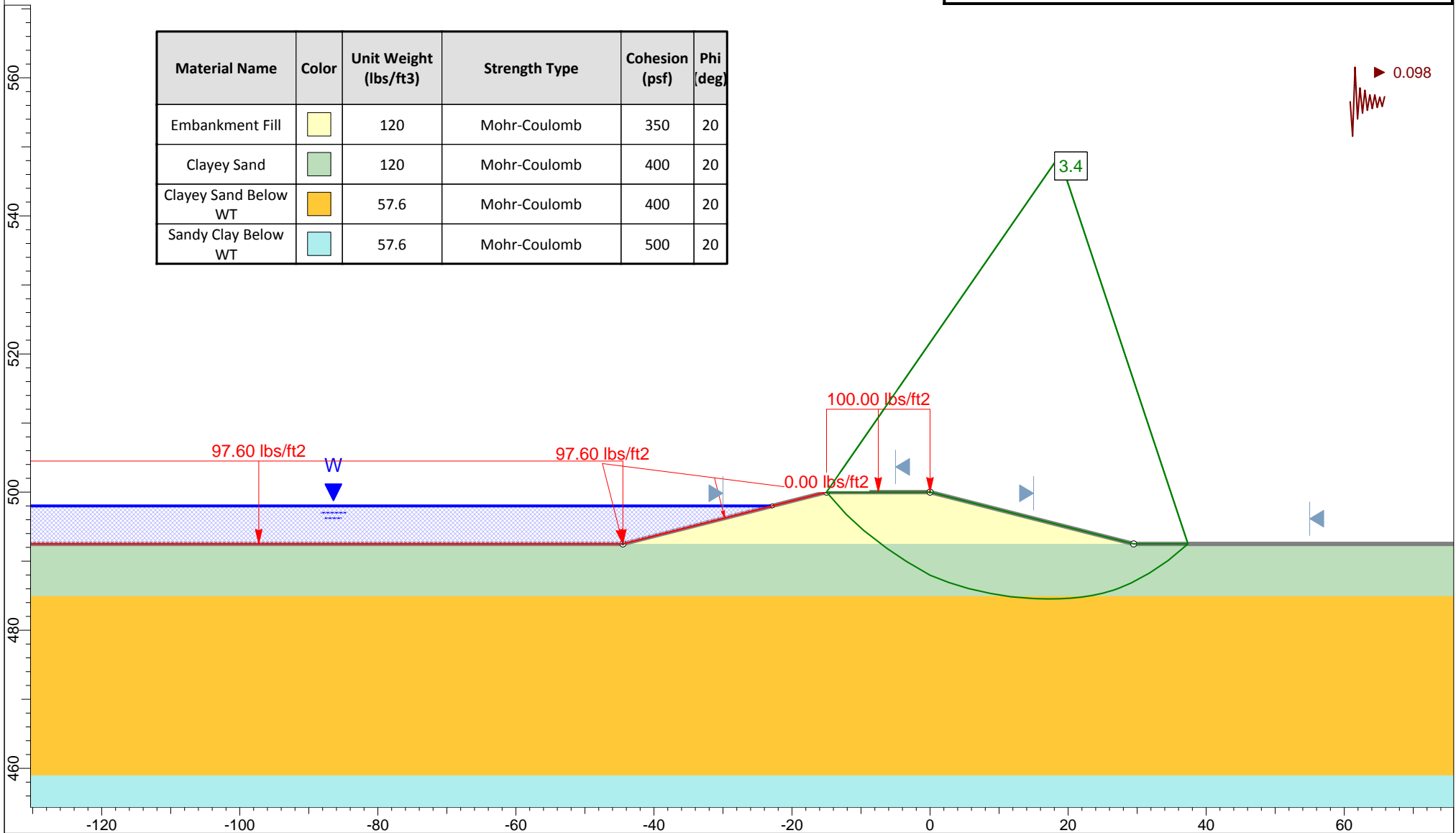





Profile "L" - Steady State
Ash Pond Berms - Spruce/Deely Generation Units

Raba Kistner Consultants, Inc.
ASA12-098-00

Figure D-25a



Global Stability Analysis

Material Name	Color	Unit Weight (lbs/ft ³)	Strength Type	Cohesion (psf)	Phi (deg)
Embankment Fill		120	Mohr-Coulomb	350	20
Clayey Sand		120	Mohr-Coulomb	400	20
Clayey Sand Below WT		57.6	Mohr-Coulomb	400	20
Sandy Clay Below WT		57.6	Mohr-Coulomb	500	20

◀ 0.098

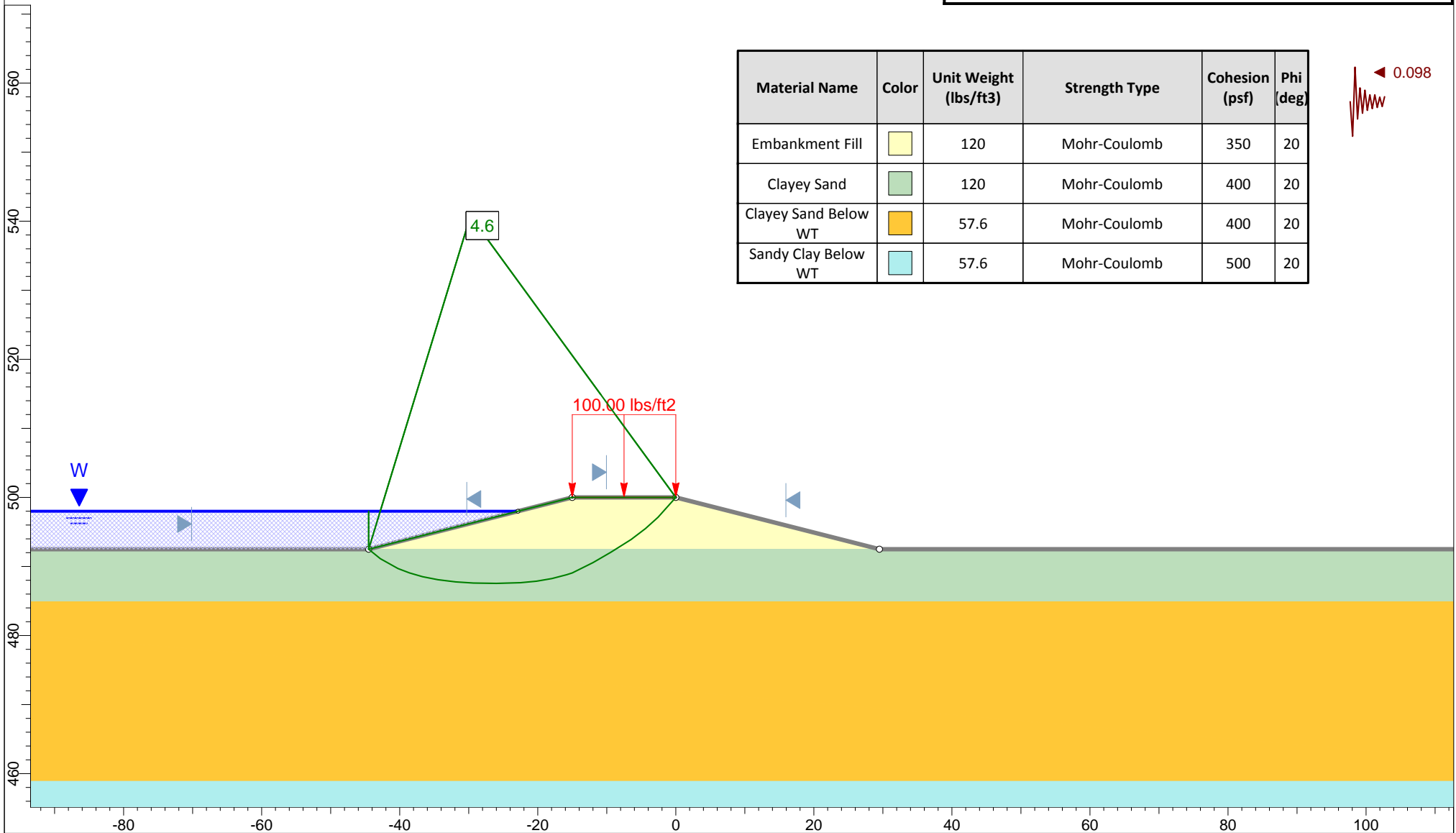



Profile "L" - Steady State
Ash Pond Berms - Spruce/Deely Generation Units

Raba Kistner Consultants, Inc.
ASA12-098-00

Figure D-25b



Global Stability Analysis

Material Name	Color	Unit Weight (lbs/ft ³)	Strength Type	Cohesion (psf)	Phi (deg)
Embankment Fill		120	Mohr-Coulomb	350	20
Sandy Clay		120	Mohr-Coulomb	500	20
Clayey Sand Below WT		57.6	Mohr-Coulomb	400	20
Sandy Clay Below WT		57.6	Mohr-Coulomb	500	20

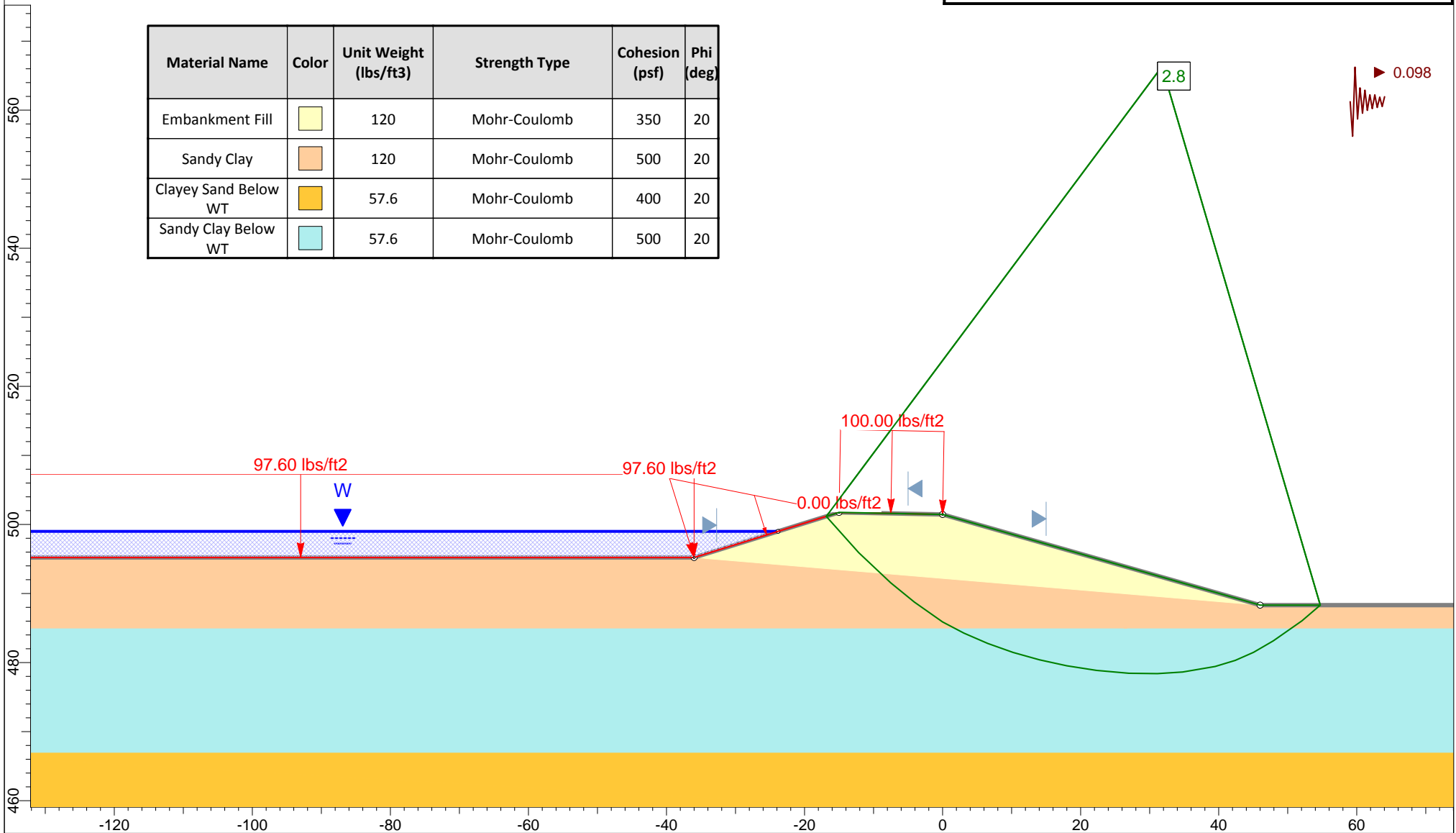





Profile "M" - Steady State
Ash Pond Berms - Spruce/Deely Generation Units

Raba Kistner Consultants, Inc.
ASA12-098-00

Figure D-26a



Global Stability Analysis

Material Name	Color	Unit Weight (lbs/ft ³)	Strength Type	Cohesion (psf)	Phi (deg)
Embankment Fill		120	Mohr-Coulomb	350	20
Sandy Clay		120	Mohr-Coulomb	500	20
Clayey Sand Below WT		57.6	Mohr-Coulomb	400	20
Sandy Clay Below WT		57.6	Mohr-Coulomb	500	20

◀ 0.098

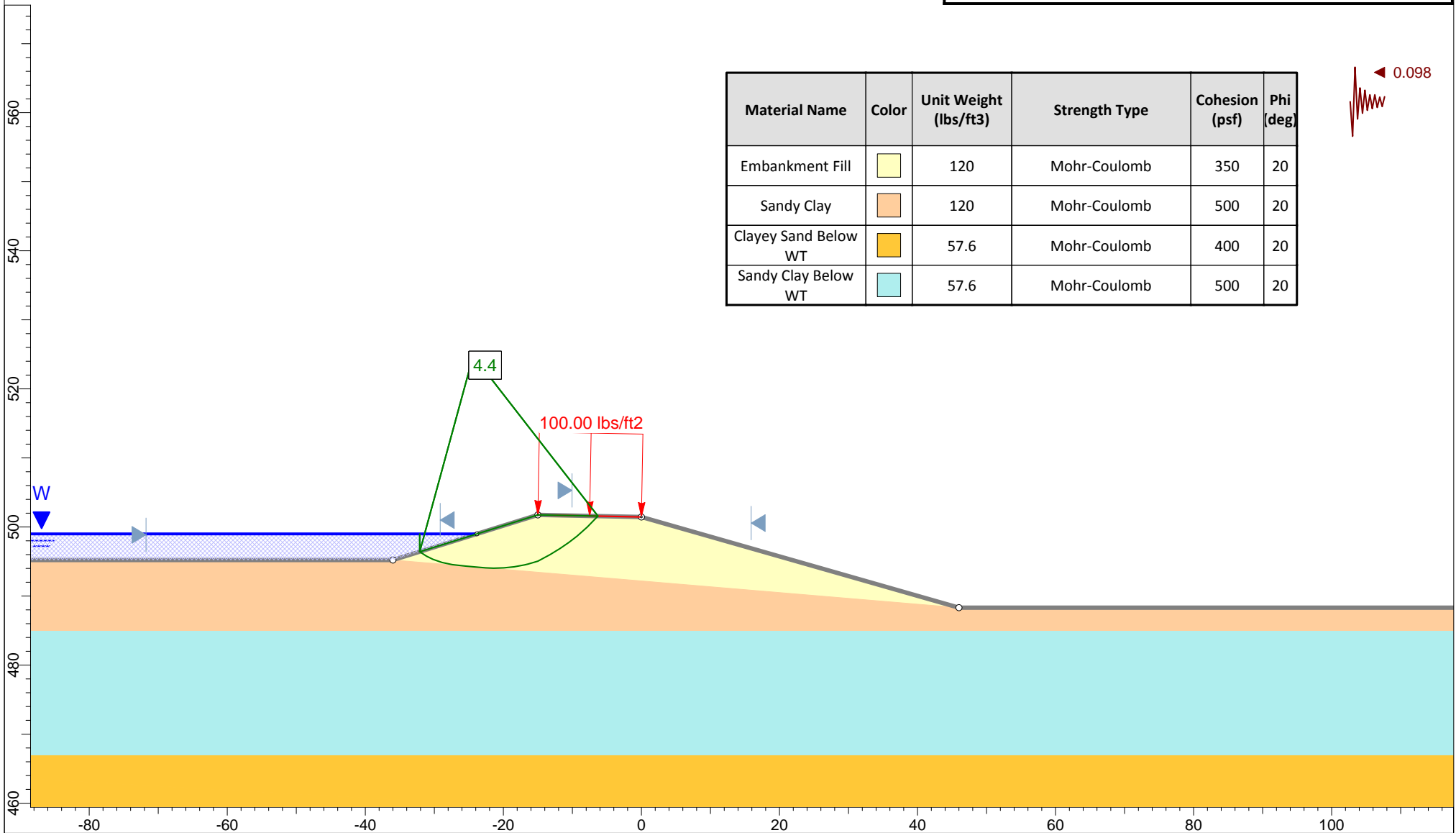

Profile "M" - Steady State
Ash Pond Berms - Spruce/Deely Generation Units

Raba Kistner Consultants, Inc.
ASA12-098-00

Figure D-26b



Global Stability Analysis

Material Name	Color	Unit Weight (lbs/ft ³)	Strength Type	Cohesion (psf)	Phi (deg)
Embankment Fill		120	Mohr-Coulomb	350	20
Clayey Sand		120	Mohr-Coulomb	400	20
Clayey Sand Below WT		57.6	Mohr-Coulomb	400	20

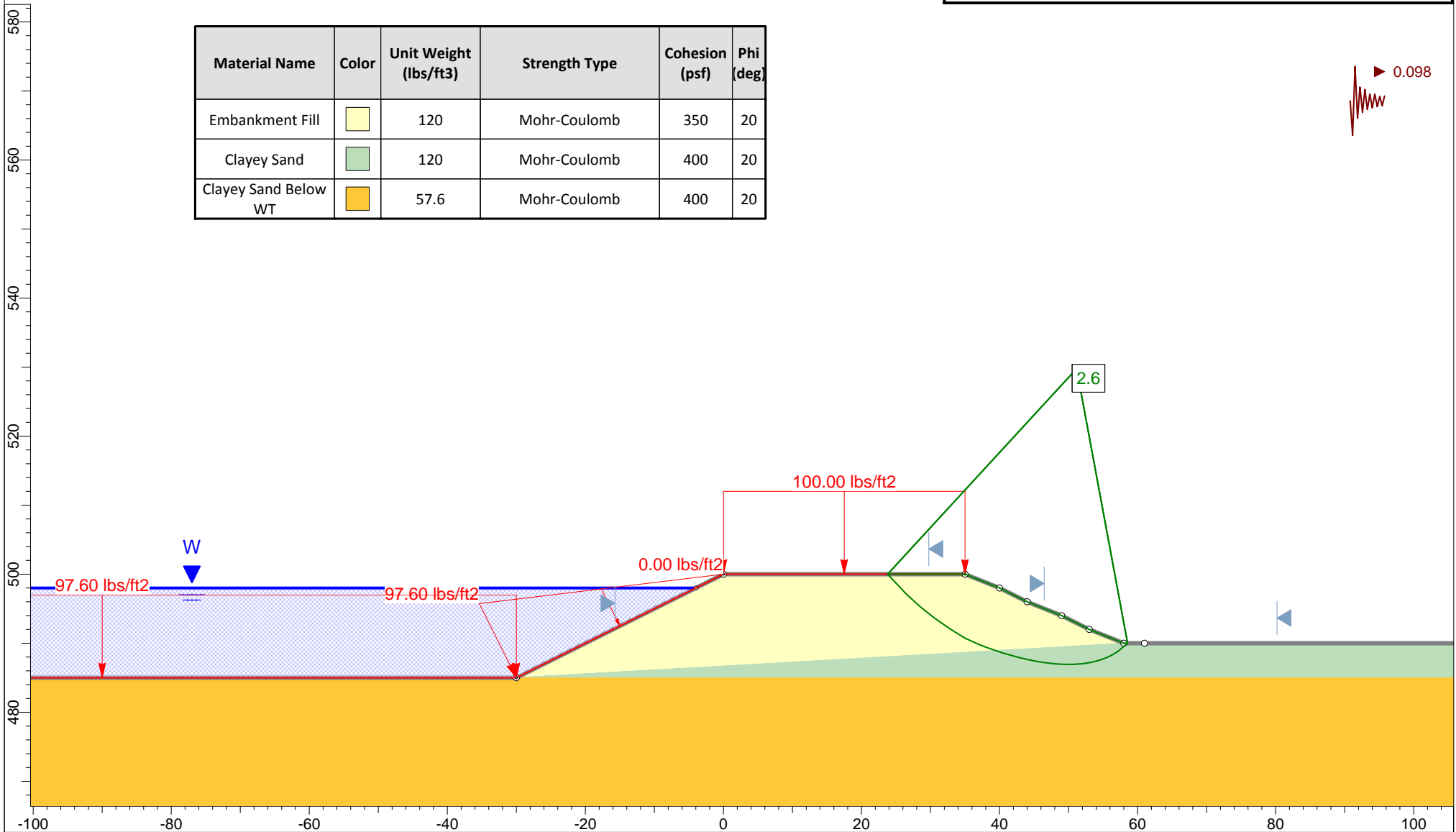

Profile "N" - Steady State
Ash Pond Berms - Spruce/Deely Generation Units

Raba Kistner Consultants, Inc.
ASA12-098-00

Figure D-27a



Global Stability Analysis

Material Name	Color	Unit Weight (lbs/ft ³)	Strength Type	Cohesion (psf)	Phi (deg)
Embankment Fill	Yellow	120	Mohr-Coulomb	350	20
Clayey Sand	Green	120	Mohr-Coulomb	400	20
Clayey Sand Below WT	Orange	57.6	Mohr-Coulomb	400	20

◀ 0.098

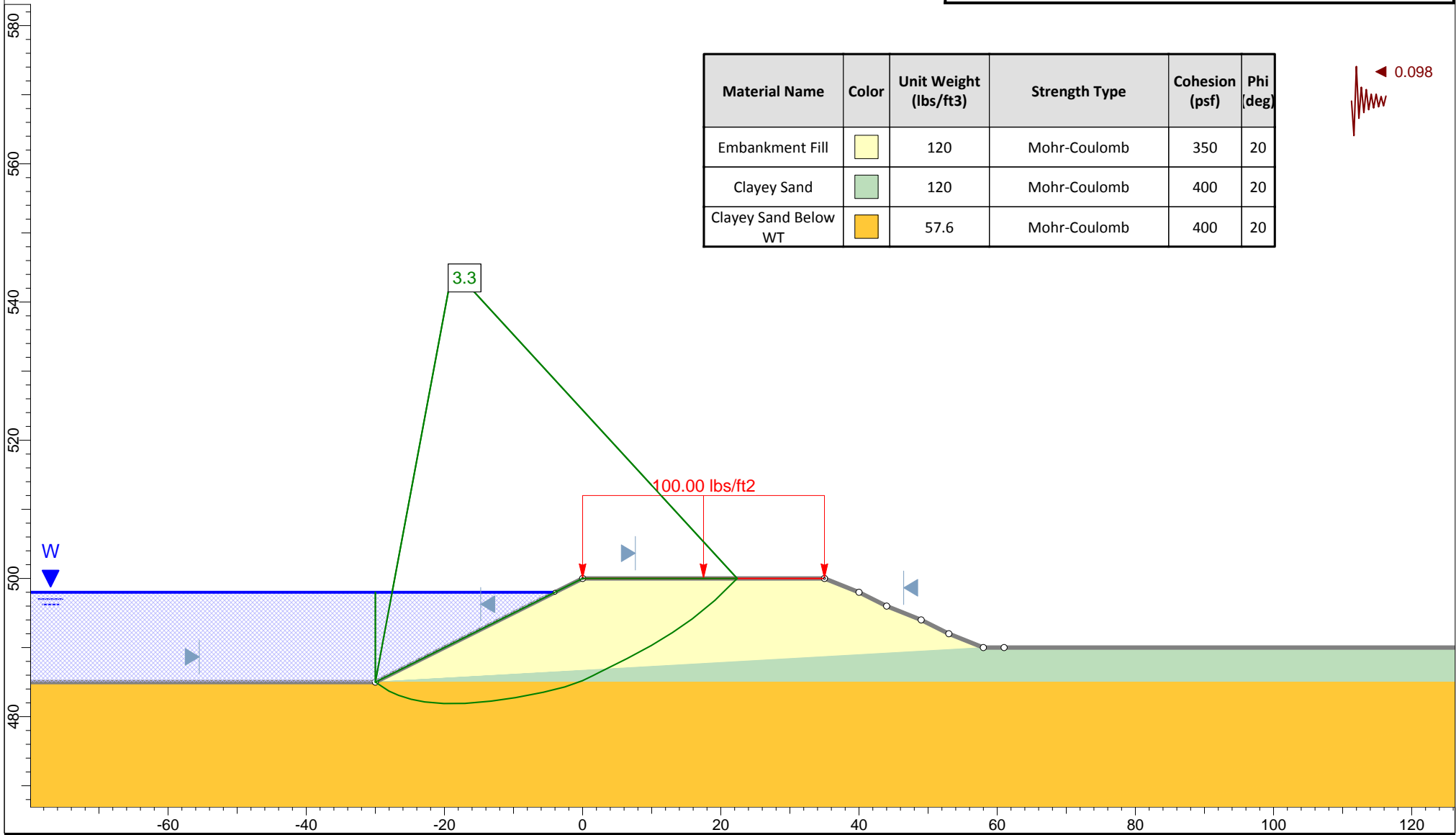



Profile "N" - Steady State
Ash Pond Berms - Spruce/Deely Generation Units

Raba Kistner Consultants, Inc.
ASA12-098-00

Figure D-27b



Global Stability Analysis

Material Name	Color	Unit Weight (lbs/ft ³)	Strength Type	Cohesion (psf)	Phi (deg)
Embankment Fill		120	Mohr-Coulomb	350	20
Clayey Sand		120	Mohr-Coulomb	400	20
Clayey Sand Below WT		57.6	Mohr-Coulomb	400	20

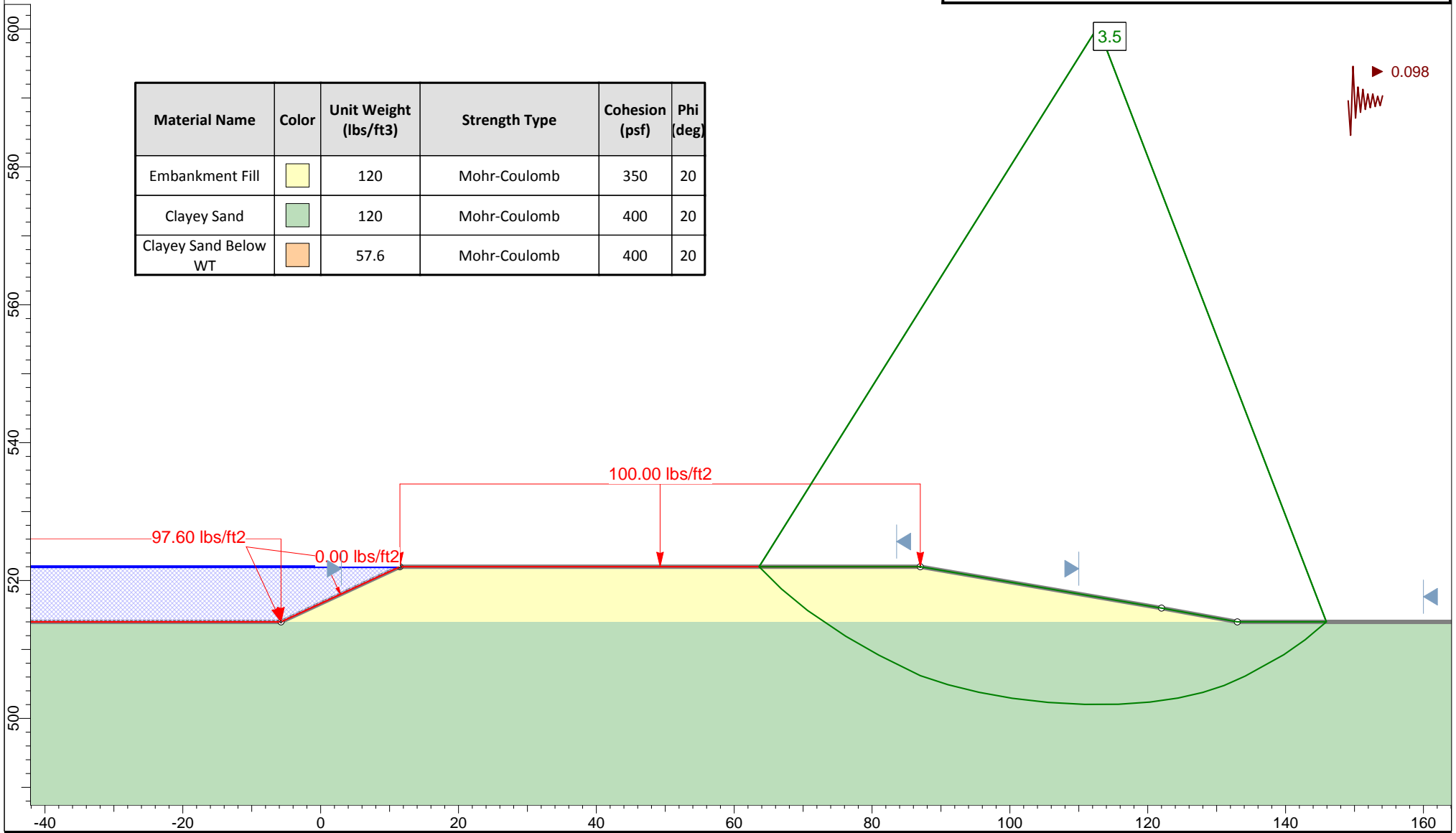

Profile "A" - Maximum Pool
Ash Pond Berms - Spruce/Deely Generation Units

Raba Kistner Consultants, Inc.
ASA12-098-00

Figure D-28a



Global Stability Analysis

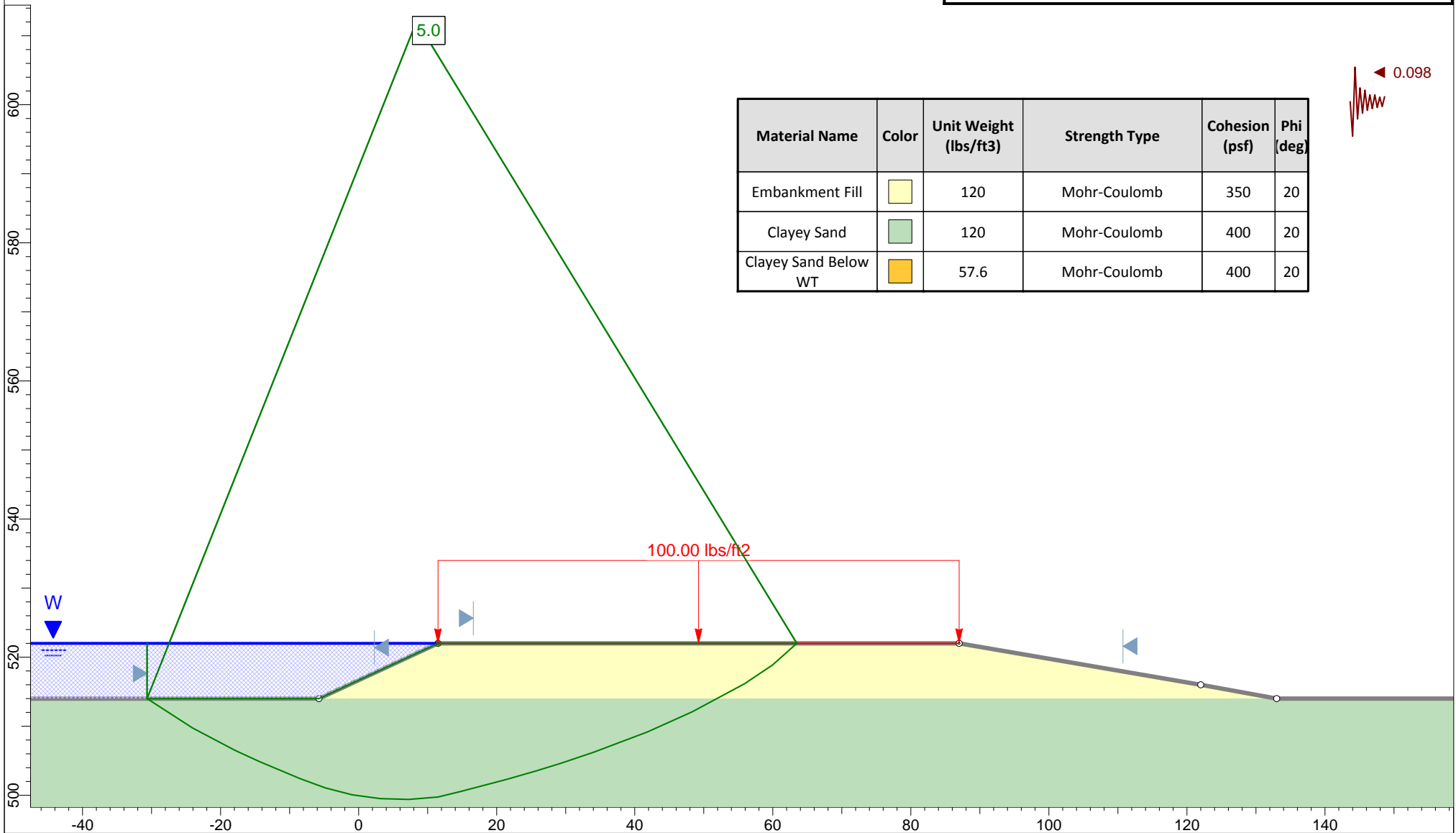





Profile "A" - Maximum Pool
Ash Pond Berms - Spruce/Deely Generation Units

Raba Kistner Consultants, Inc.
ASA12-098-00

Figure D-28b



Global Stability Analysis

Material Name	Color	Unit Weight (lbs/ft ³)	Strength Type	Cohesion (psf)	Phi (deg)
Embankment Fill		120	Mohr-Coulomb	350	20
Clayey Sand		120	Mohr-Coulomb	400	20
Sandy Clay		120	Mohr-Coulomb	500	20
Clayey Sand Below WT		57.6	Mohr-Coulomb	400	20

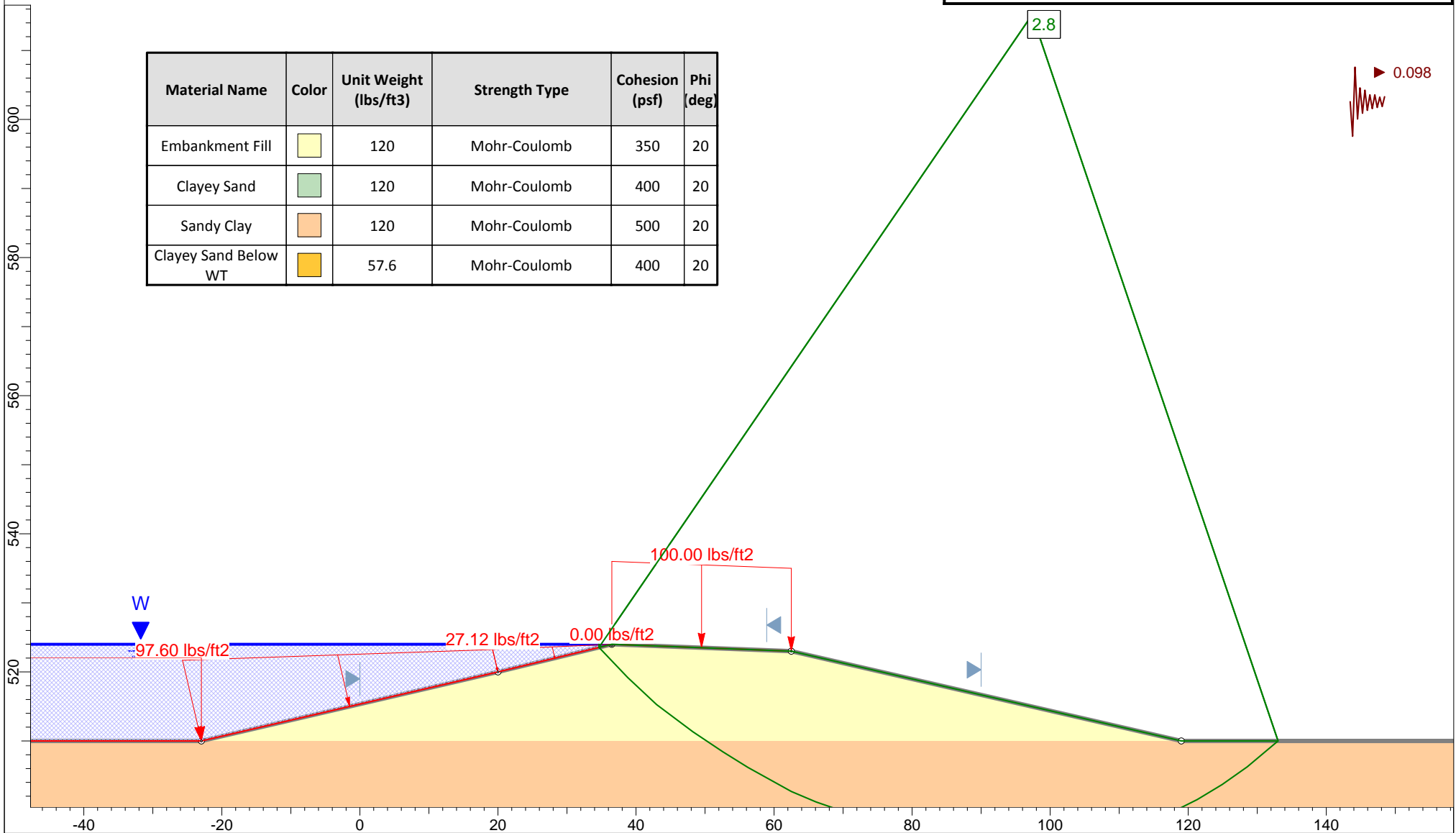

Profile "B" - Maximum Pool
Ash Pond Berms - Spruce/Deely Generation Units

Raba Kistner Consultants, Inc.
ASA12-098-00

Figure D-29a



Global Stability Analysis

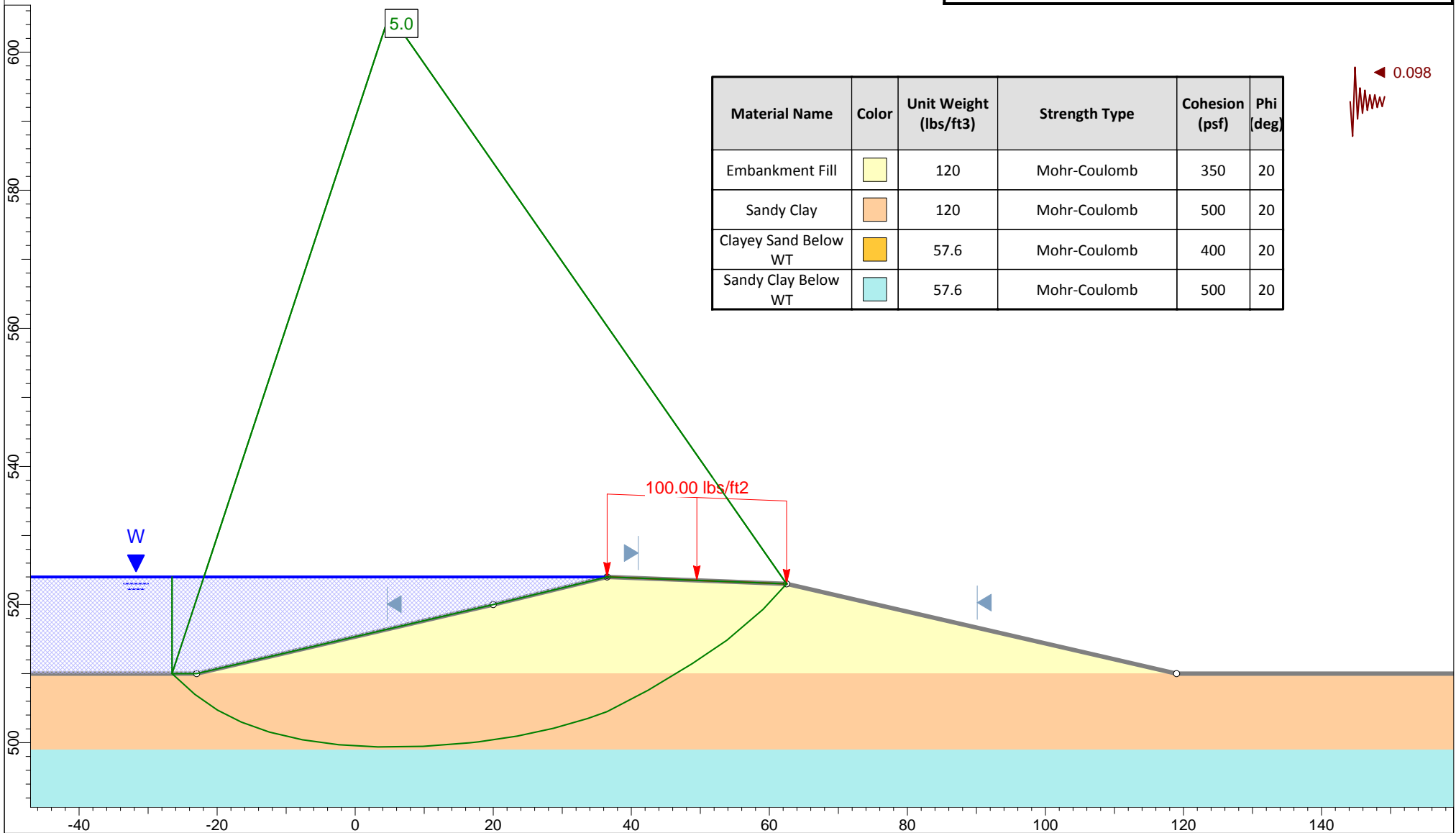

Material Name	Color	Unit Weight (lbs/ft ³)	Strength Type	Cohesion (psf)	Phi (deg)
Embankment Fill	Yellow	120	Mohr-Coulomb	350	20
Sandy Clay	Orange	120	Mohr-Coulomb	500	20
Clayey Sand Below WT	Yellow	57.6	Mohr-Coulomb	400	20
Sandy Clay Below WT	Cyan	57.6	Mohr-Coulomb	500	20



Profile "B" - Maximum Pool
Ash Pond Berms - Spruce/Deely Generation Units

Raba Kistner Consultants, Inc.
ASA12-098-00

Figure D-29b



Global Stability Analysis

Material Name	Color	Unit Weight (lbs/ft3)	Strength Type	Cohesion (psf)	Phi (deg)
Embankment Fill		120	Mohr-Coulomb	350	20
Clayey Sand		120	Mohr-Coulomb	400	20
Clayey Sand Below WT		57.6	Mohr-Coulomb	400	20

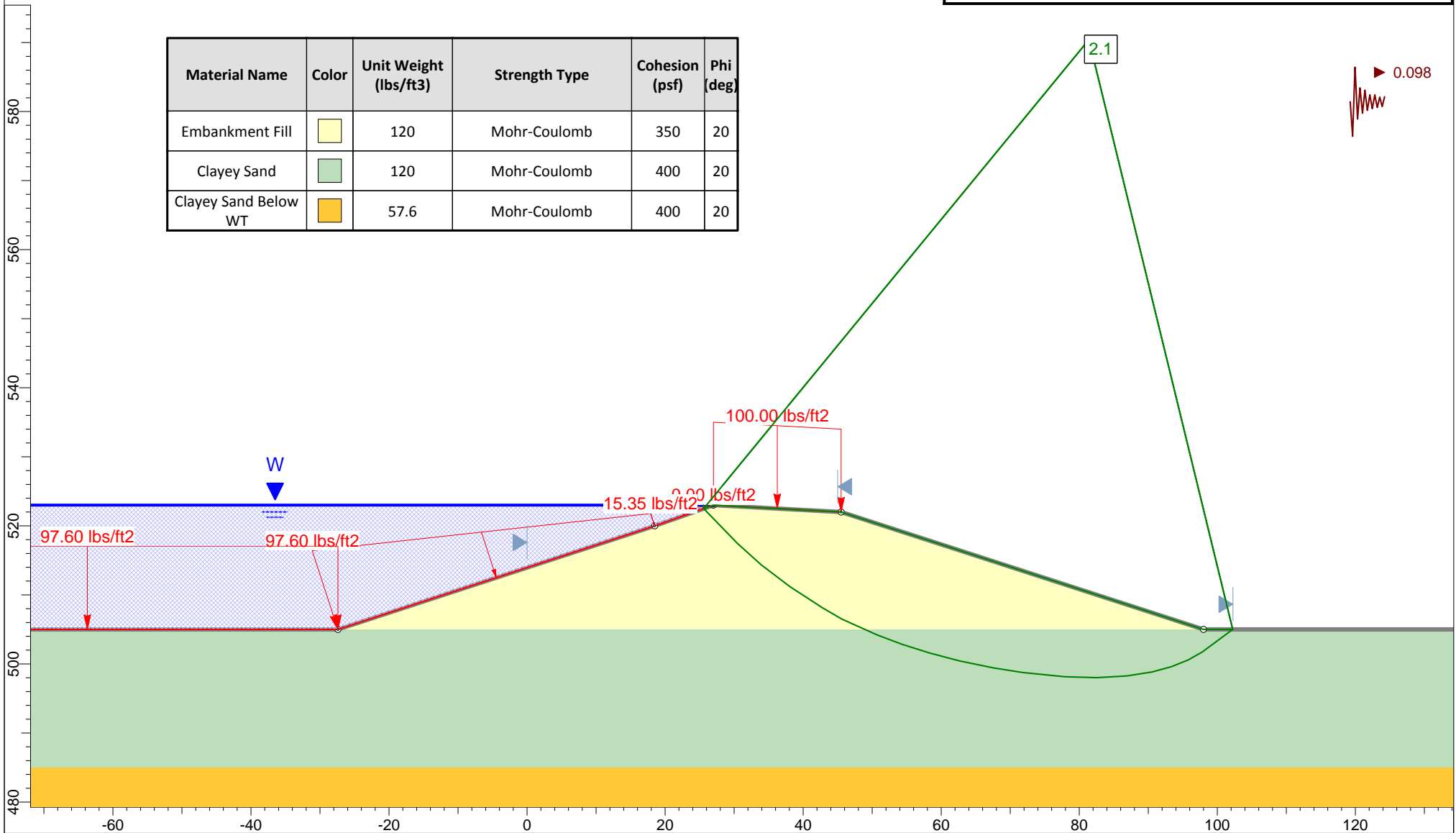

Profile "C" - Maximum Pool
Ash Pond Berms - Spruce/Deely Generation Units

Raba Kistner Consultants, Inc.
ASA12-098-00

Figure D-30a



Global Stability Analysis

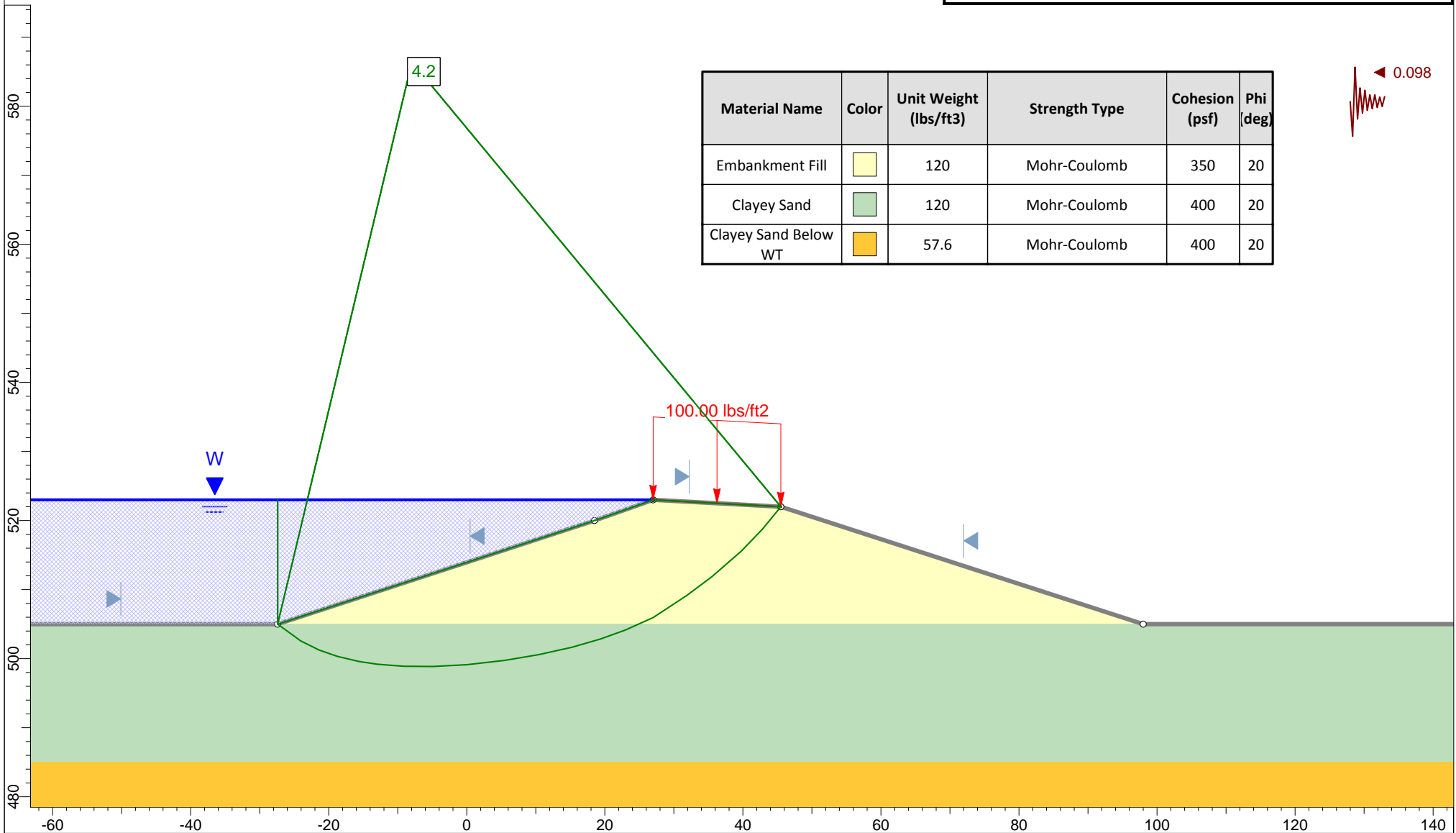





Profile "C" - Maximum Pool
Ash Pond Berms - Spruce/Deely Generation Units

Raba Kistner Consultants, Inc.
ASA12-098-00

Figure D-30b



Global Stability Analysis

Material Name	Color	Unit Weight (lbs/ft ³)	Strength Type	Cohesion (psf)	Phi (deg)
Embankment Fill		120	Mohr-Coulomb	350	20
Clayey Sand		120	Mohr-Coulomb	400	20
Sandy Clay		120	Mohr-Coulomb	500	20
Clayey Sand Below WT		57.6	Mohr-Coulomb	400	20

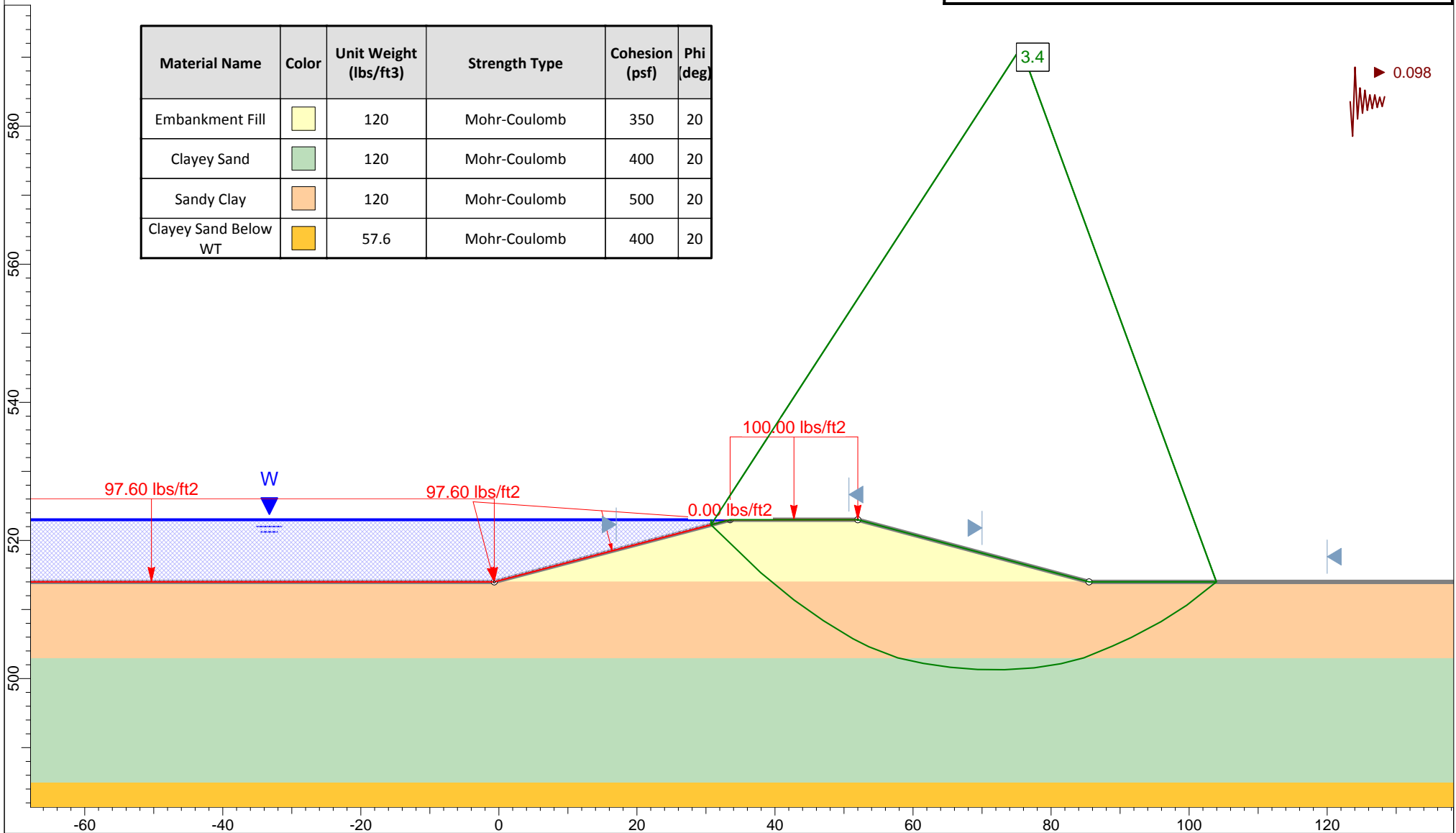

Profile "D" - Maximum Pool
Ash Pond Berms - Spruce/Deely Generation Units

Raba Kistner Consultants, Inc.
ASA12-098-00

Figure D-31a



Global Stability Analysis

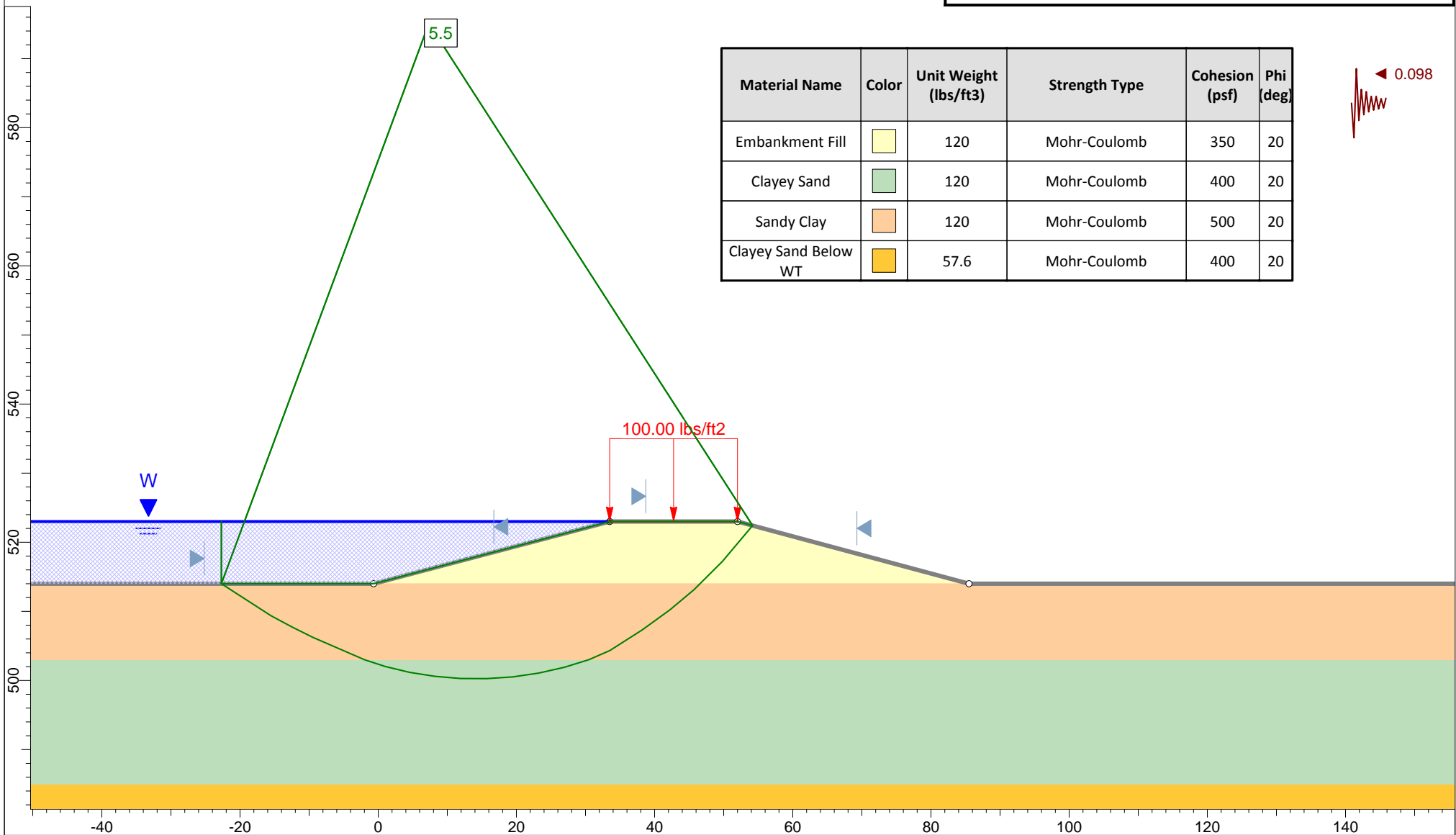

Material Name	Color	Unit Weight (lbs/ft3)	Strength Type	Cohesion (psf)	Phi (deg)
Embankment Fill	Yellow	120	Mohr-Coulomb	350	20
Clayey Sand	Green	120	Mohr-Coulomb	400	20
Sandy Clay	Orange	120	Mohr-Coulomb	500	20
Clayey Sand Below WT	Yellow-Orange	57.6	Mohr-Coulomb	400	20

0.098



Profile "D" - Maximum Pool
Ash Pond Berms - Spruce/Deely Generation Units

Raba Kistner Consultants, Inc.
ASA12-098-00

Figure D-31b



Global Stability Analysis

Material Name	Color	Unit Weight (lbs/ft ³)	Strength Type	Cohesion (psf)	Phi (deg)
Embankment Soil		120	Mohr-Coulomb	350	20
Sandy Clay		120	Mohr-Coulomb	500	20
Clayey Sand Below WT		57.6	Mohr-Coulomb	400	20

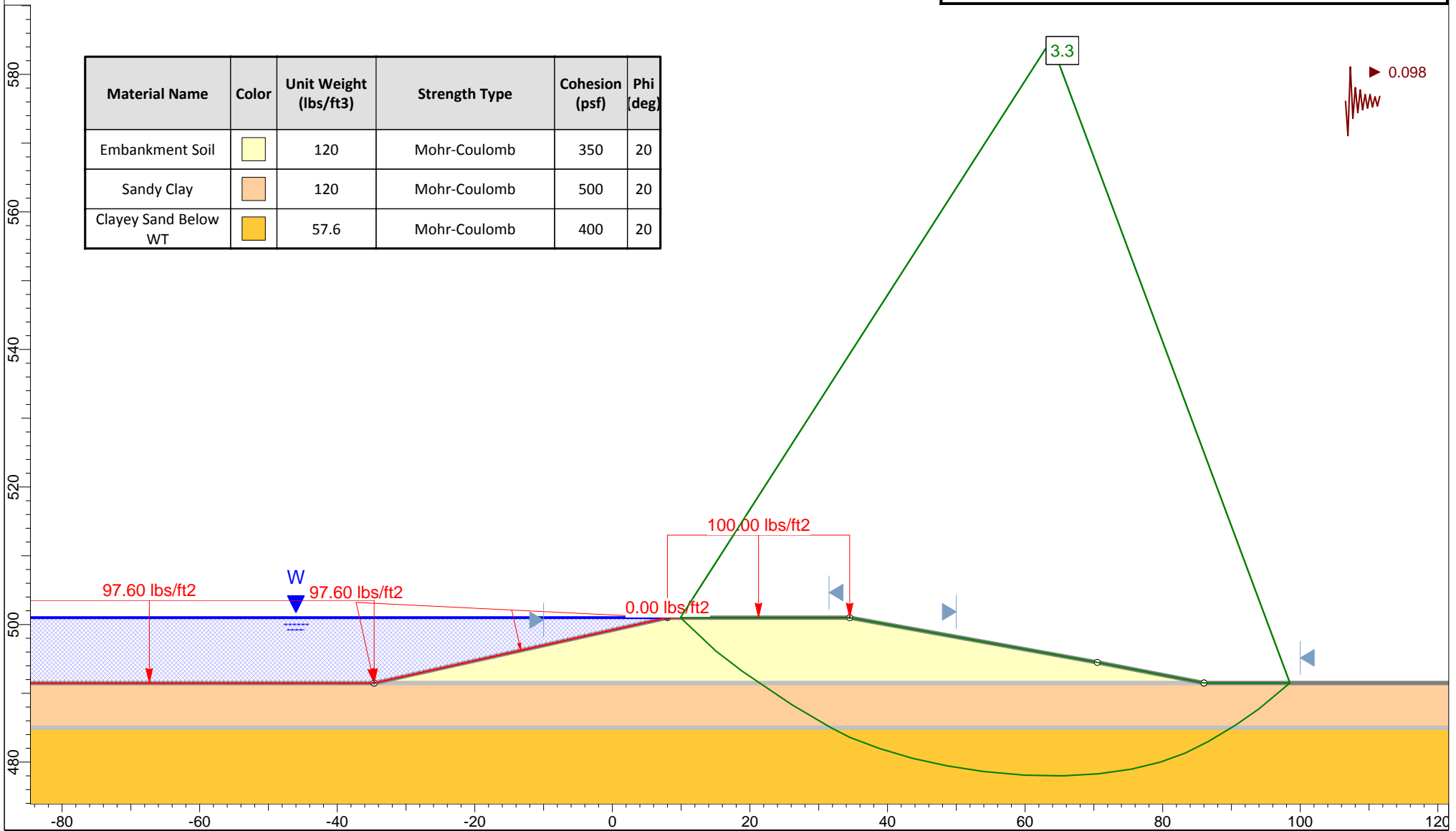

Profile "E" - Maximum Pool
Ash Pond Berms - Spruce/Deely Generation Units

Raba Kistner Consultants, Inc.
ASA12-098-00

Figure D-32a



Global Stability Analysis

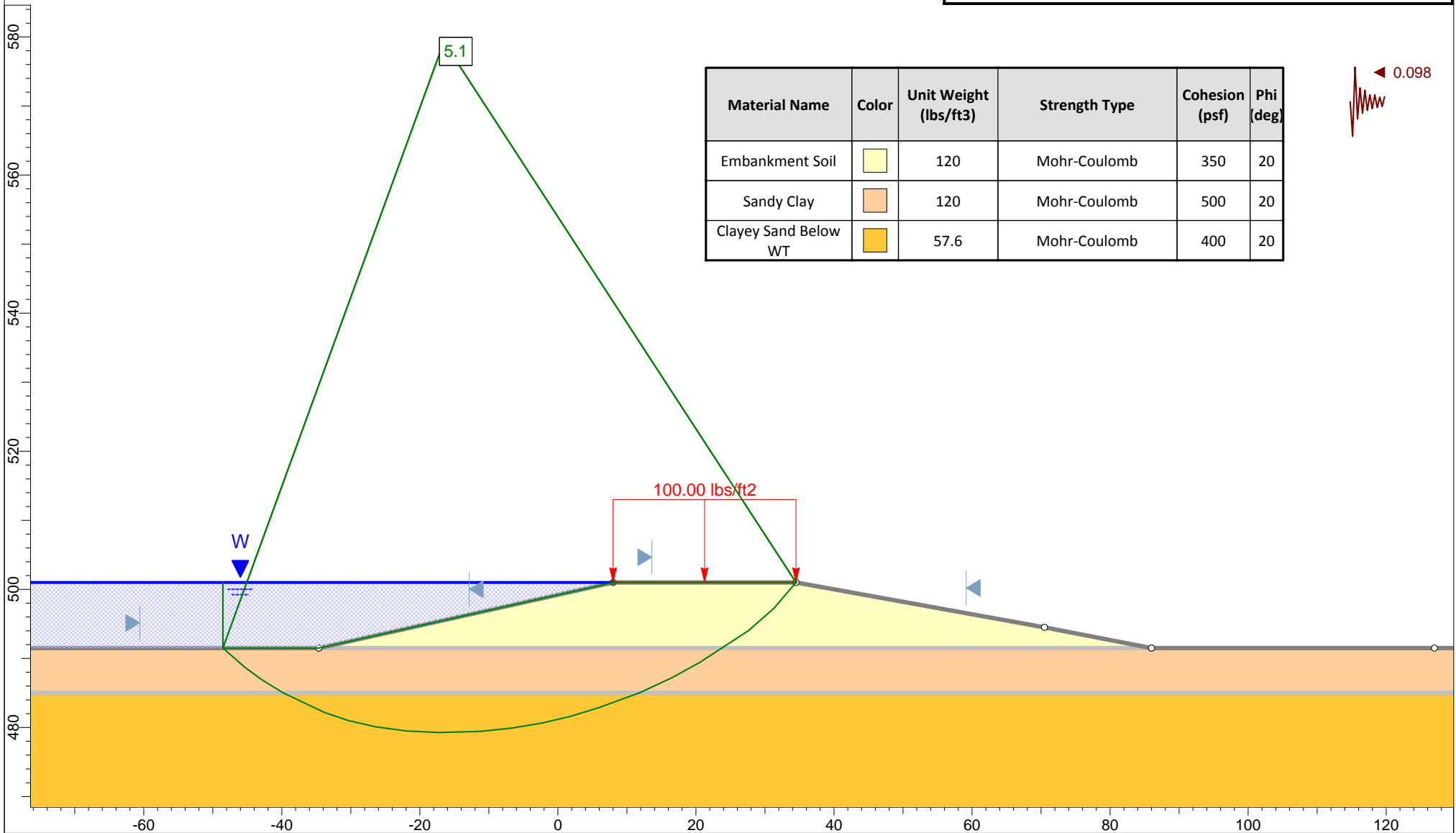





Profile "E" - Maximum Pool
Ash Pond Berms - Spruce/Deely Generation Units

Raba Kistner Consultants, Inc.
ASA12-098-00

Figure D-32b



Global Stability Analysis

Material Name	Color	Unit Weight (lbs/ft ³)	Strength Type	Cohesion (psf)	Phi (deg)
Embankment Fill		120	Mohr-Coulomb	350	20
Clayey Sand		120	Mohr-Coulomb	400	20
Clayey Sand Below WT		57.6	Mohr-Coulomb	400	20
Sandy Clay Below WT		57.6	Mohr-Coulomb	500	20

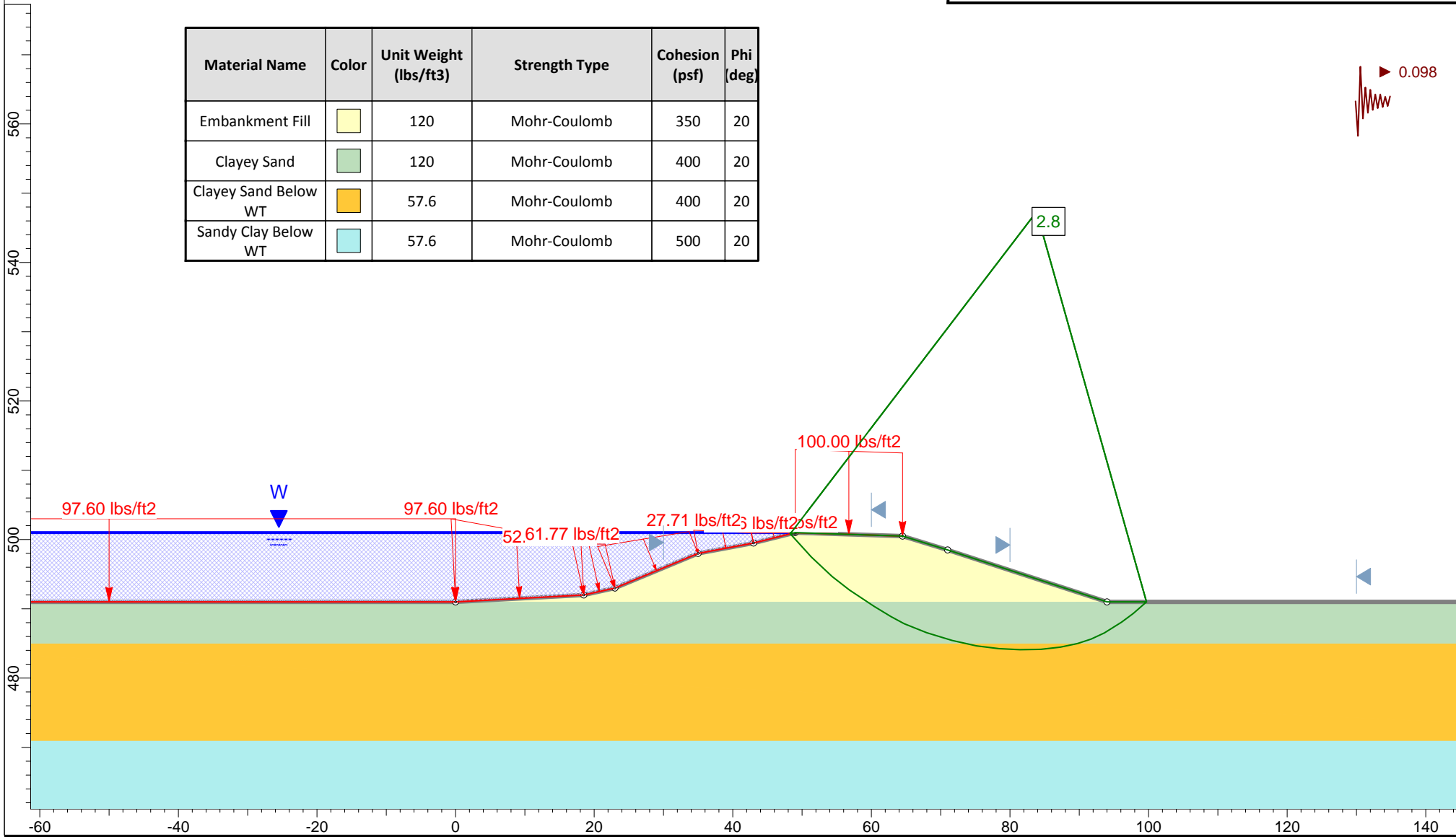





Profile "F" - Maximum Pool
Ash Pond Berms - Spruce/Deely Generation Units

Raba Kistner Consultants, Inc.
ASA12-098-00

Figure D-33a



Global Stability Analysis

Material Name	Color	Unit Weight (lbs/ft ³)	Strength Type	Cohesion (psf)	Phi (deg)
Embankment Fill		120	Mohr-Coulomb	350	20
Clayey Sand		120	Mohr-Coulomb	400	20
Clayey Sand Below WT		57.6	Mohr-Coulomb	400	20
Sandy Clay Below WT		57.6	Mohr-Coulomb	500	20

◀ 0.098

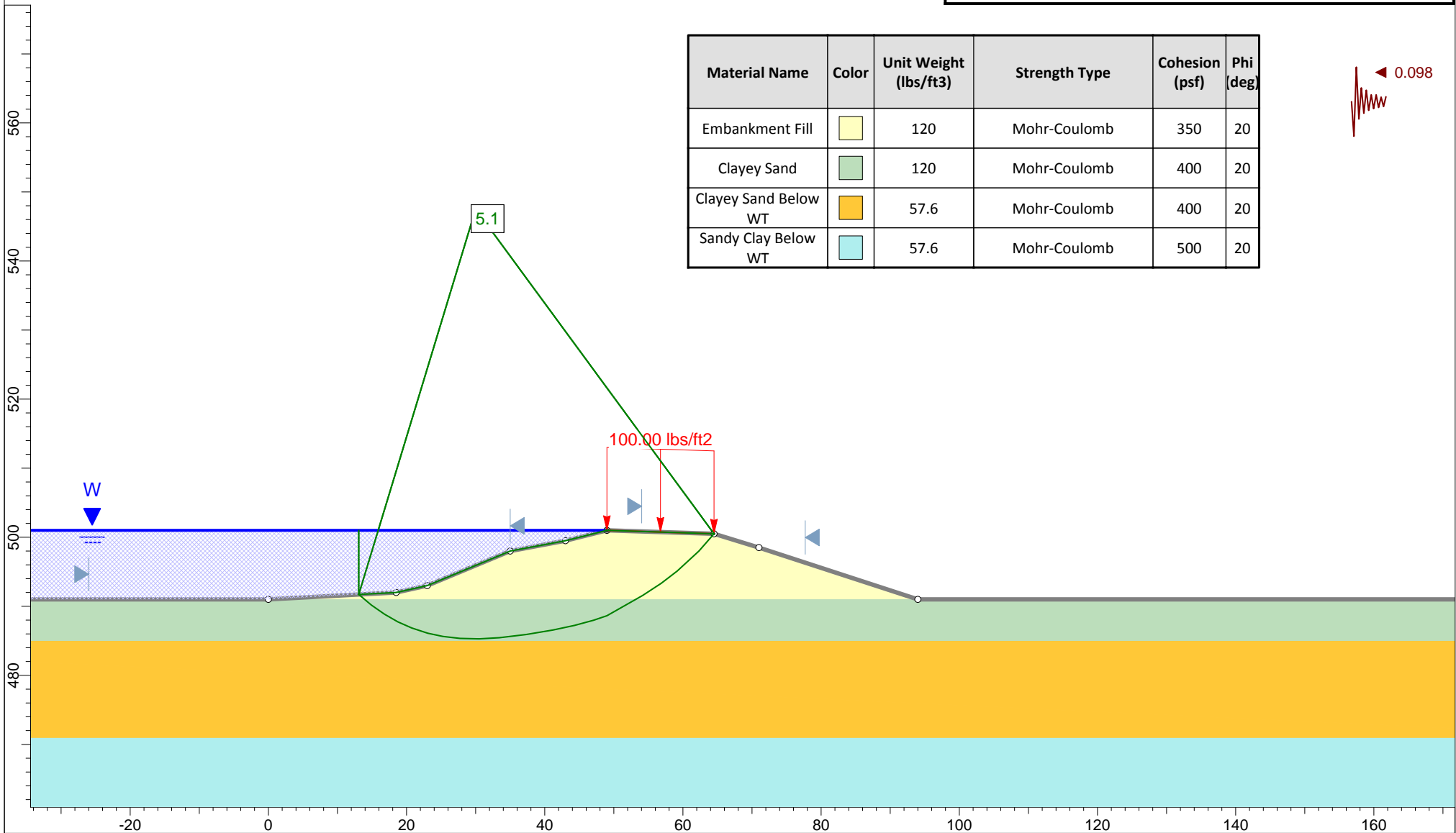

Profile "F" - Maximum Pool
Ash Pond Berms - Spruce/Deely Generation Units

Raba Kistner Consultants, Inc.
ASA12-098-00

Figure D-33b



Global Stability Analysis

Material Name	Color	Unit Weight (lbs/ft ³)	Strength Type	Cohesion (psf)	Phi (deg)
Embankment Fill		120	Mohr-Coulomb	350	20
Clayey Sand Below WT		57.6	Mohr-Coulomb	400	20
Sandy Clay Below WT		57.6	Mohr-Coulomb	500	20

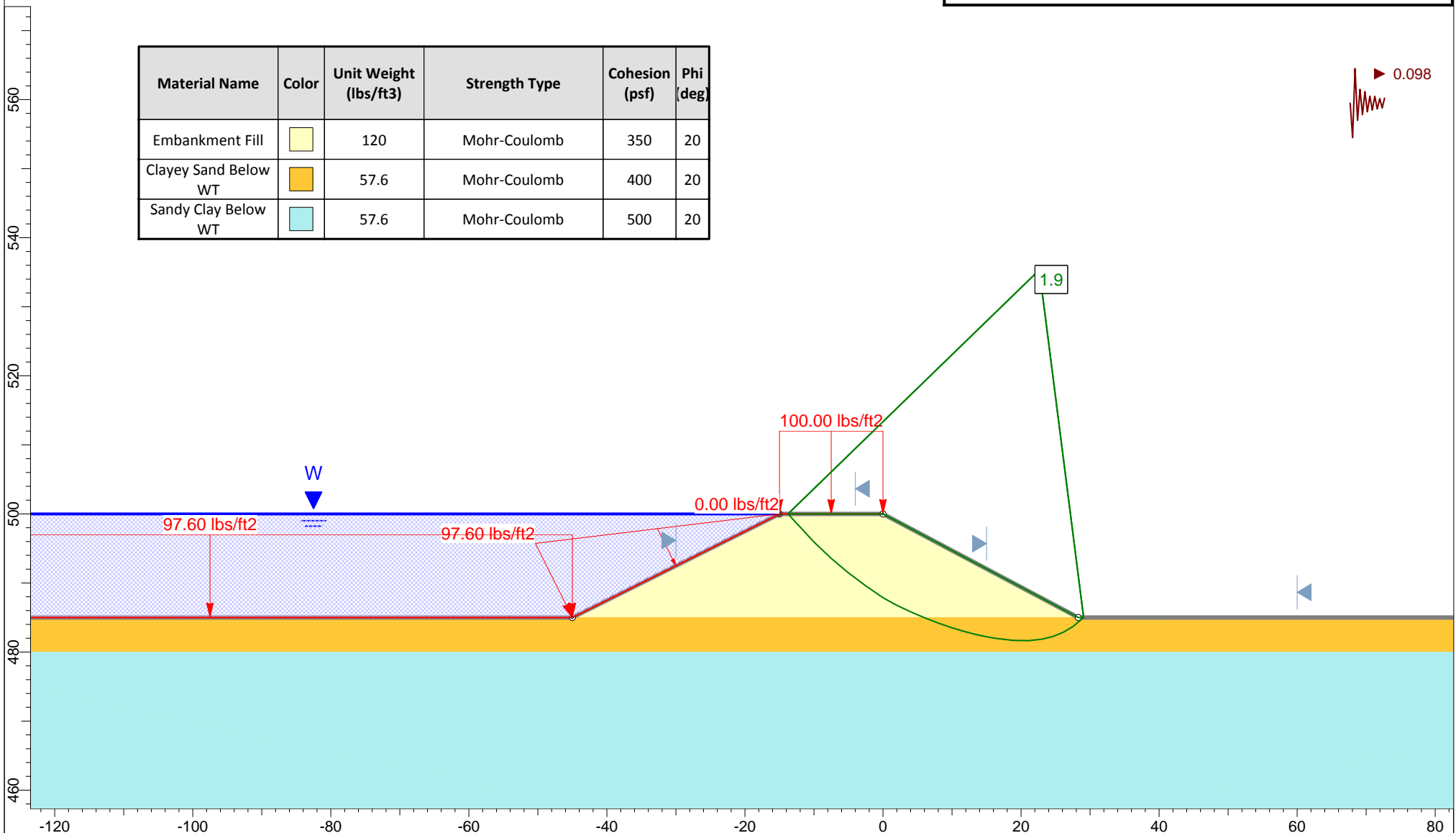

Profile "G" - Maximum Pool
Ash Pond Berms - Spruce/Deely Generation Units

Raba Kistner Consultants, Inc.
ASA12-098-00

Figure D-34a



Global Stability Analysis

Material Name	Color	Unit Weight (lbs/ft ³)	Strength Type	Cohesion (psf)	Phi (deg)
Embankment Fill	Yellow	120	Mohr-Coulomb	350	20
Clayey Sand Below WT	Orange	57.6	Mohr-Coulomb	400	20
Sandy Clay Below WT	Light Blue	57.6	Mohr-Coulomb	500	20

◀ 0.098

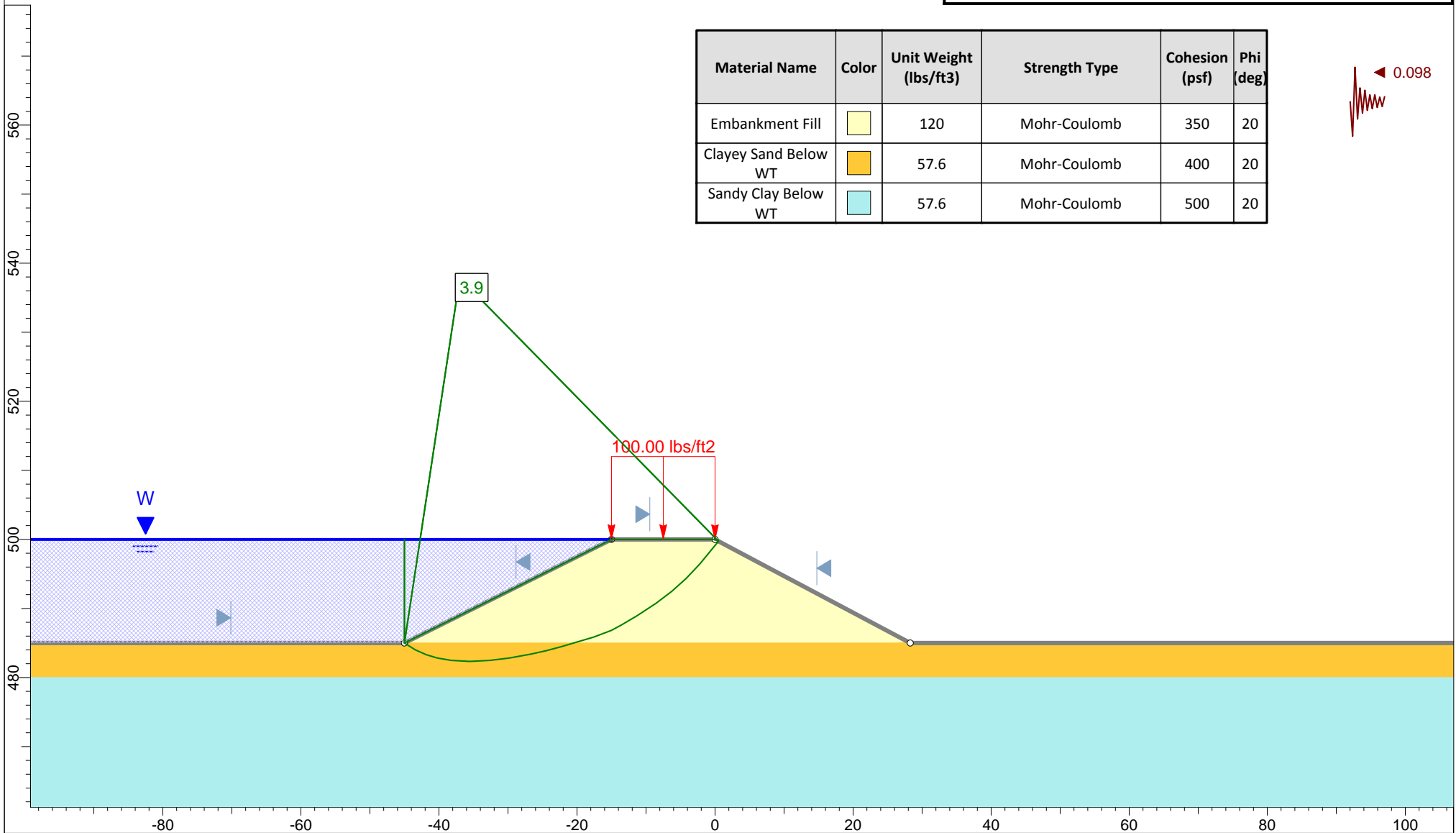





Profile "G" - Maximum Pool
Ash Pond Berms - Spruce/Deely Generation Units

Raba Kistner Consultants, Inc.
ASA12-098-00

Figure D-34b



Global Stability Analysis

Material Name	Color	Unit Weight (lbs/ft ³)	Strength Type	Cohesion (psf)	Phi (deg)
Embankment Fill		120	Mohr-Coulomb	350	20
Sandy Clay		120	Mohr-Coulomb	500	20
Clayey Sand Below WT		57.6	Mohr-Coulomb	400	20
Sandy Clay Below WT		57.6	Mohr-Coulomb	500	20

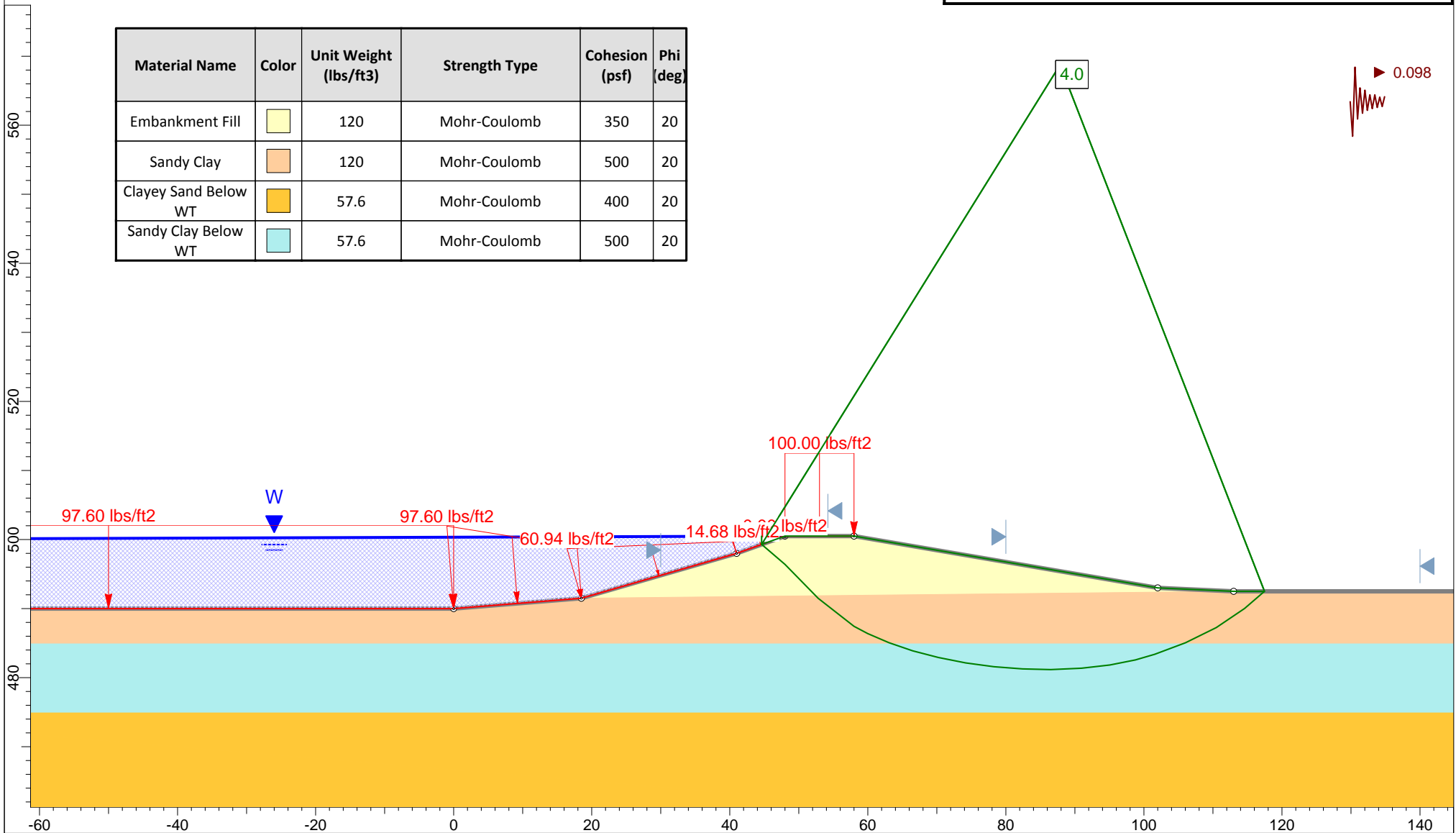





Profile "H" - Maximum Pool
Ash Pond Berms - Spruce/Deely Generation Units

Raba Kistner Consultants, Inc.
ASA12-098-00

Figure D-35a



Global Stability Analysis

Material Name	Color	Unit Weight (lbs/ft ³)	Strength Type	Cohesion (psf)	Phi (deg)
Embankment Fill		120	Mohr-Coulomb	350	20
Sandy Clay		120	Mohr-Coulomb	500	20
Clayey Sand Below WT		57.6	Mohr-Coulomb	400	20
Sandy Clay Below WT		57.6	Mohr-Coulomb	500	20

 0.098

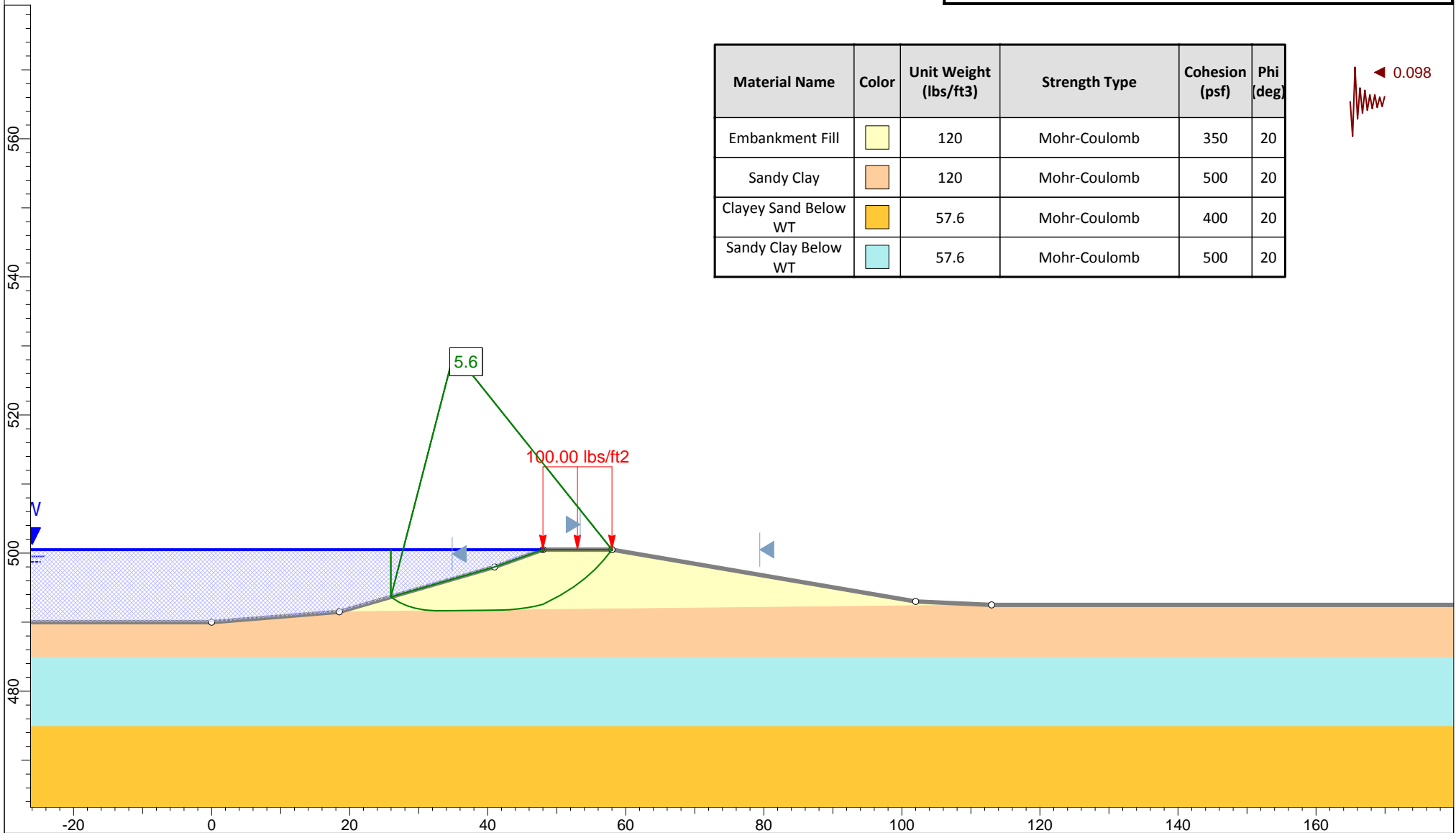





Profile "H" - Maximum Pool
Ash Pond Berms - Calaveras Lake Power Plant

Raba Kistner Consultants, Inc.
ASA12-098-00

Figure D-35b



Global Stability Analysis

Material Name	Color	Unit Weight (lbs/ft ³)	Strength Type	Cohesion (psf)	Phi (deg)
Embankment Fill		120	Mohr-Coulomb	350	20
Sandy Clay		120	Mohr-Coulomb	500	20
Clayey Sand Below WT		57.6	Mohr-Coulomb	400	20
Sandy Clay Below WT		57.6	Mohr-Coulomb	500	20

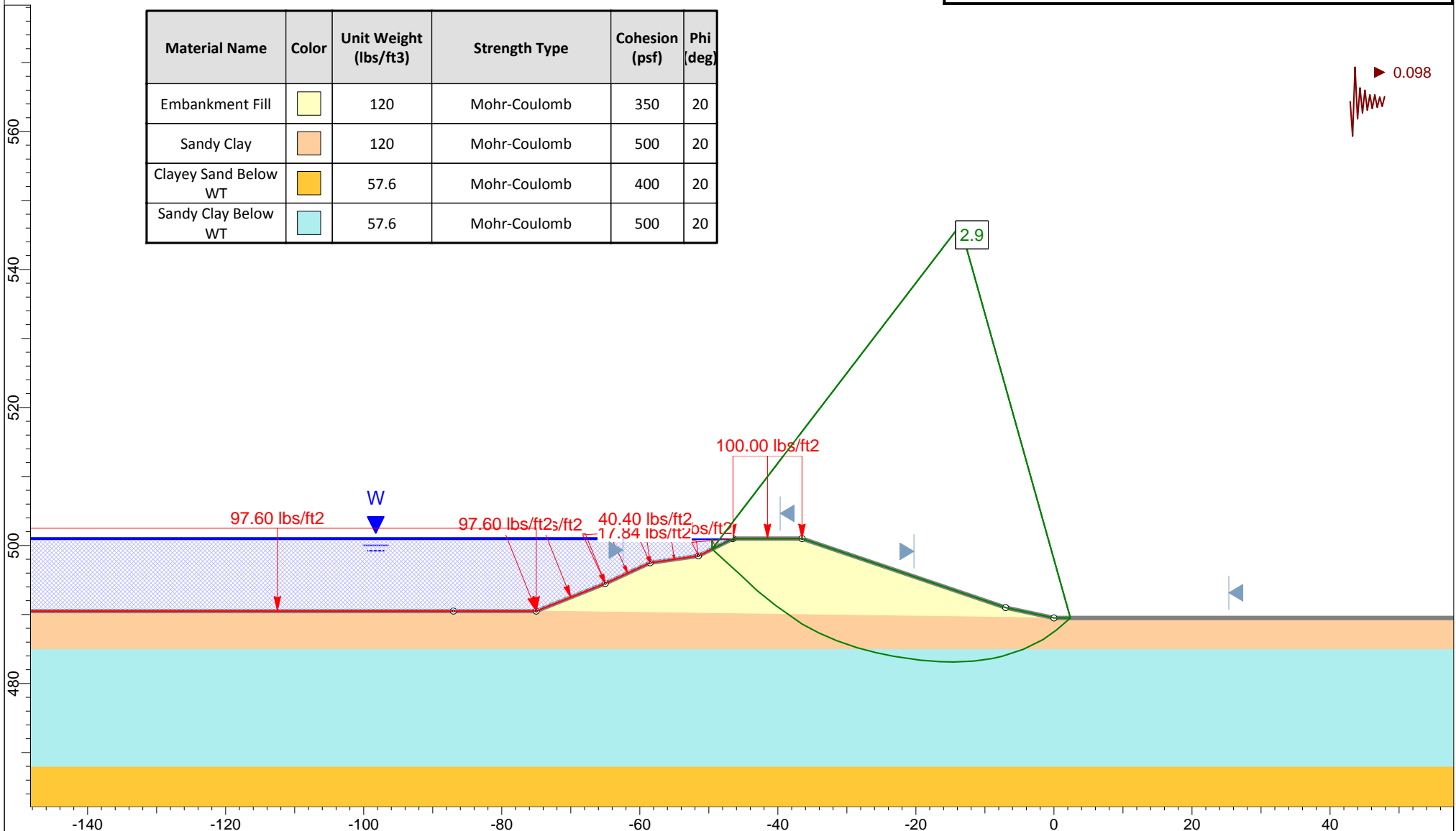

Profile "I" - Maximum Pool
Ash Pond Berms - Spruce/Deely Generation Units

Raba Kistner Consultants, Inc.
ASA12-098-00

Figure D-36a



Global Stability Analysis

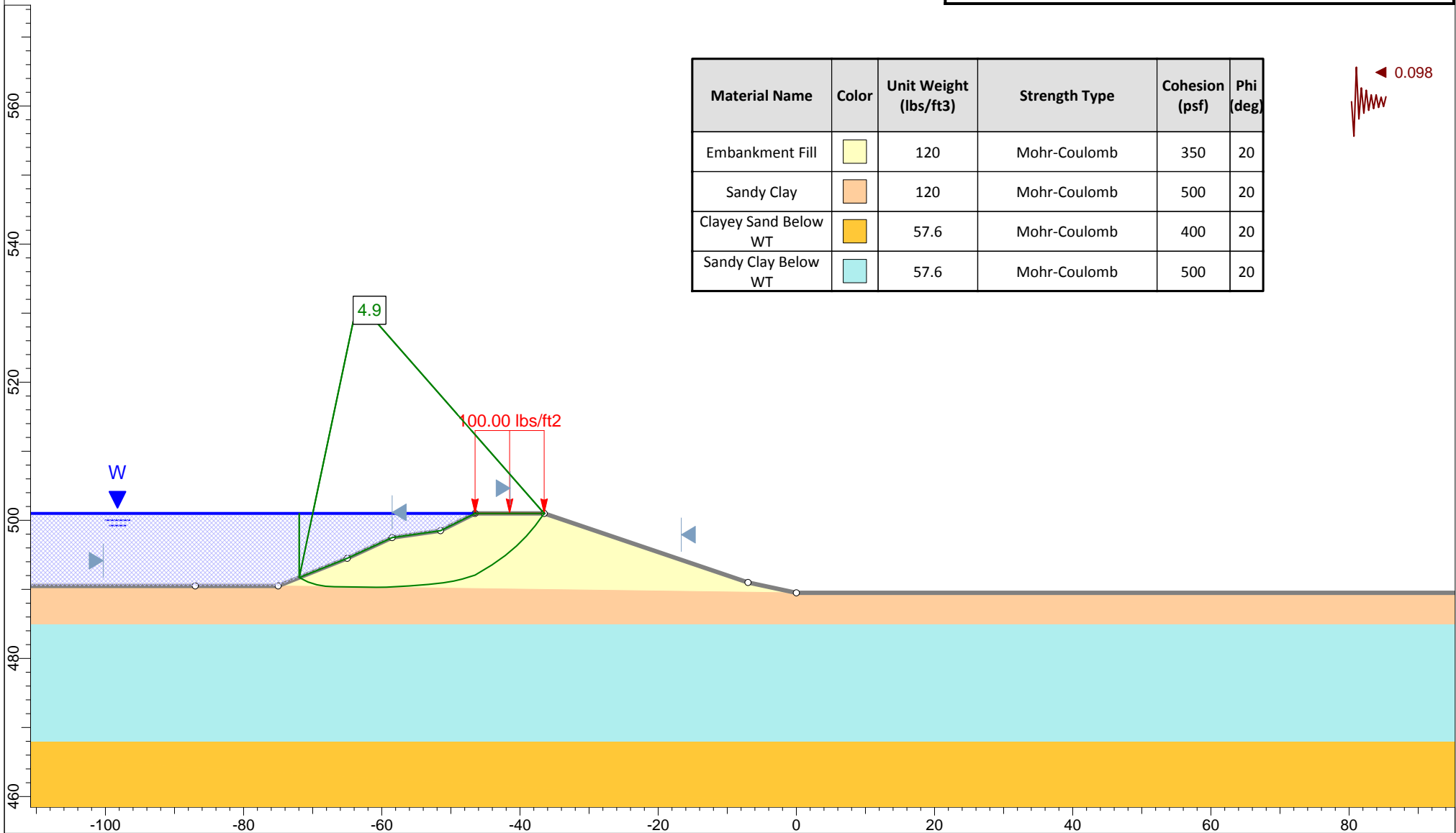



Material Name	Color	Unit Weight (lbs/ft ³)	Strength Type	Cohesion (psf)	Phi (deg)
Embankment Fill	Yellow	120	Mohr-Coulomb	350	20
Sandy Clay	Orange	120	Mohr-Coulomb	500	20
Clayey Sand Below WT	Yellow	57.6	Mohr-Coulomb	400	20
Sandy Clay Below WT	Cyan	57.6	Mohr-Coulomb	500	20

Profile "I" - Maximum Pool
Ash Pond Berms - Spruce/Deely Generation Units

Raba Kistner Consultants, Inc.
ASA12-098-00

Figure D-36b

Global Stability Analysis

Material Name	Color	Unit Weight (lbs/ft ³)	Strength Type	Cohesion (psf)	Phi (deg)
Embankment Fill		120	Mohr-Coulomb	350	20
Clayey Sand		120	Mohr-Coulomb	400	20
Clayey Sand Below WT		57.6	Mohr-Coulomb	400	20

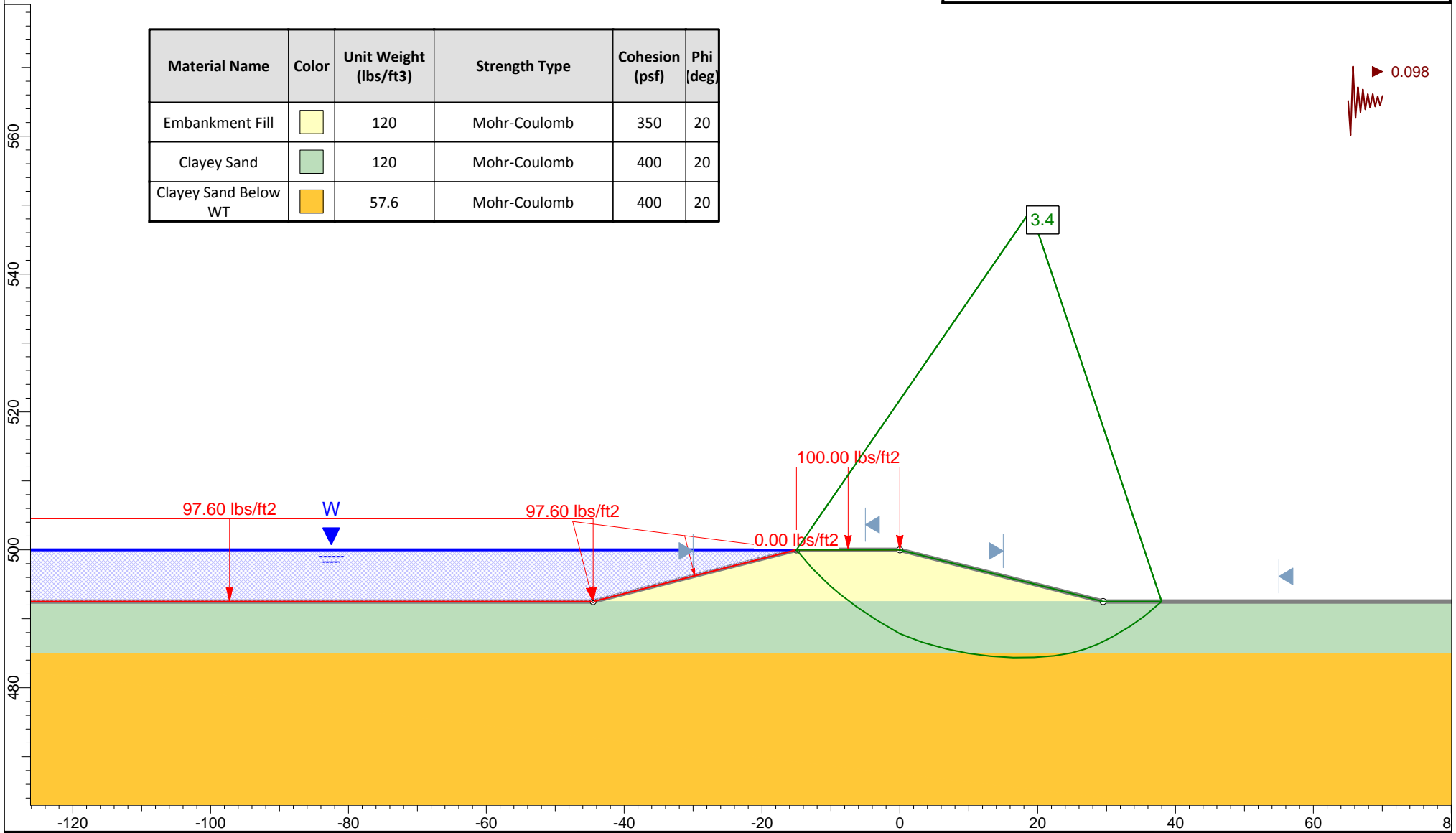



Profile "J" - Maximum Pool
Ash Pond Berms - Spruce/Deely Generation Units

Raba Kistner Consultants, Inc.
ASA12-098-00

Figure D-37a



Global Stability Analysis

Material Name	Color	Unit Weight (lbs/ft ³)	Strength Type	Cohesion (psf)	Phi (deg)
Embankment Fill		120	Mohr-Coulomb	350	20
Clayey Sand		120	Mohr-Coulomb	400	20
Clayey Sand Below WT		57.6	Mohr-Coulomb	400	20

 0.098

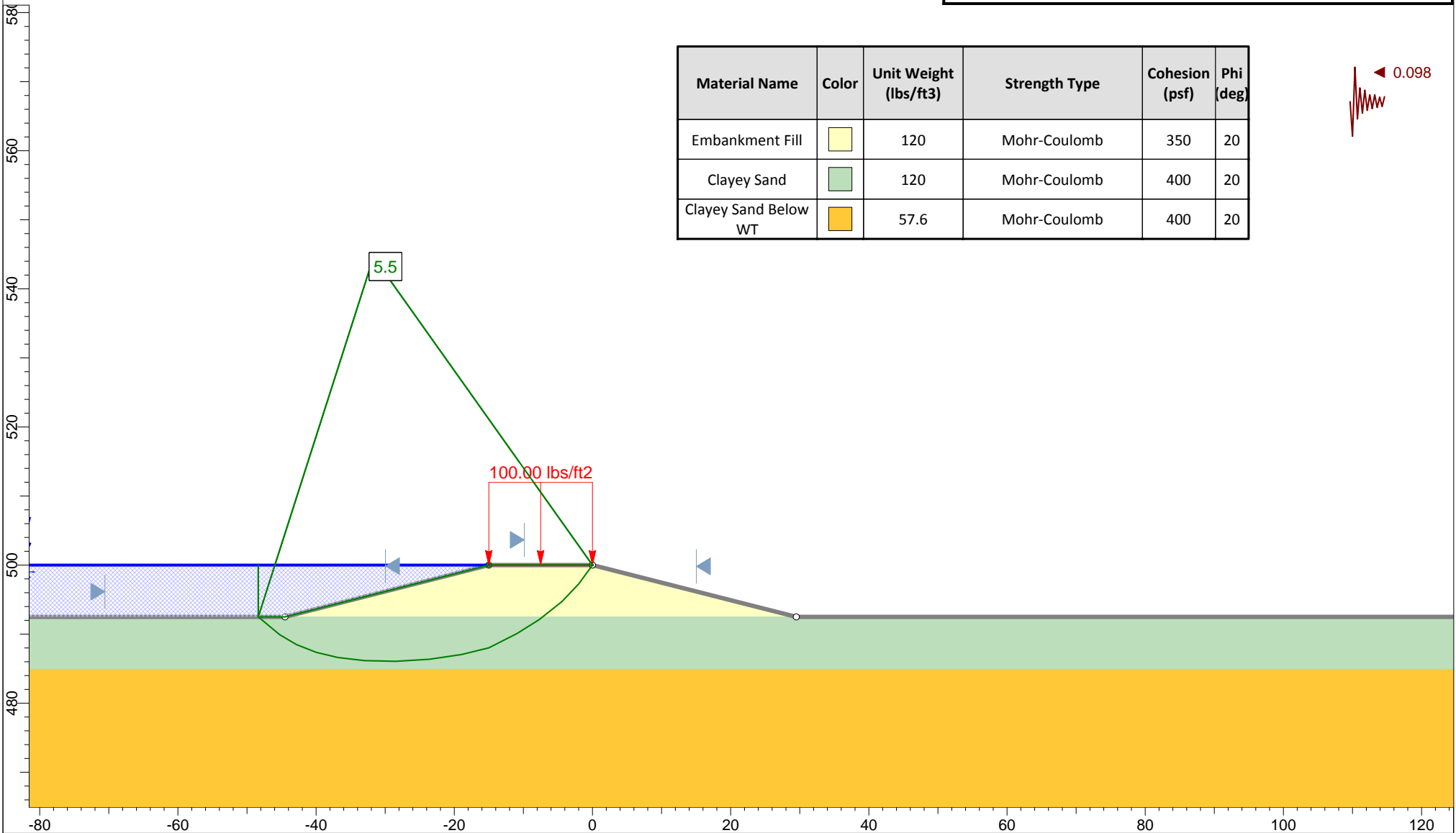



Profile "J" - Maximum Pool
Ash Pond Berms - Spruce/Deely Generation Units

Raba Kistner Consultants, Inc.
ASA12-098-00

Figure D-37b



Global Stability Analysis

Material Name	Color	Unit Weight (lbs/ft ³)	Strength Type	Cohesion (psf)	Phi (deg)
Embankment Fill		120	Mohr-Coulomb	350	20
Sandy Clay		120	Mohr-Coulomb	500	20
Sandy Clay Below WT		57.6	Mohr-Coulomb	500	20

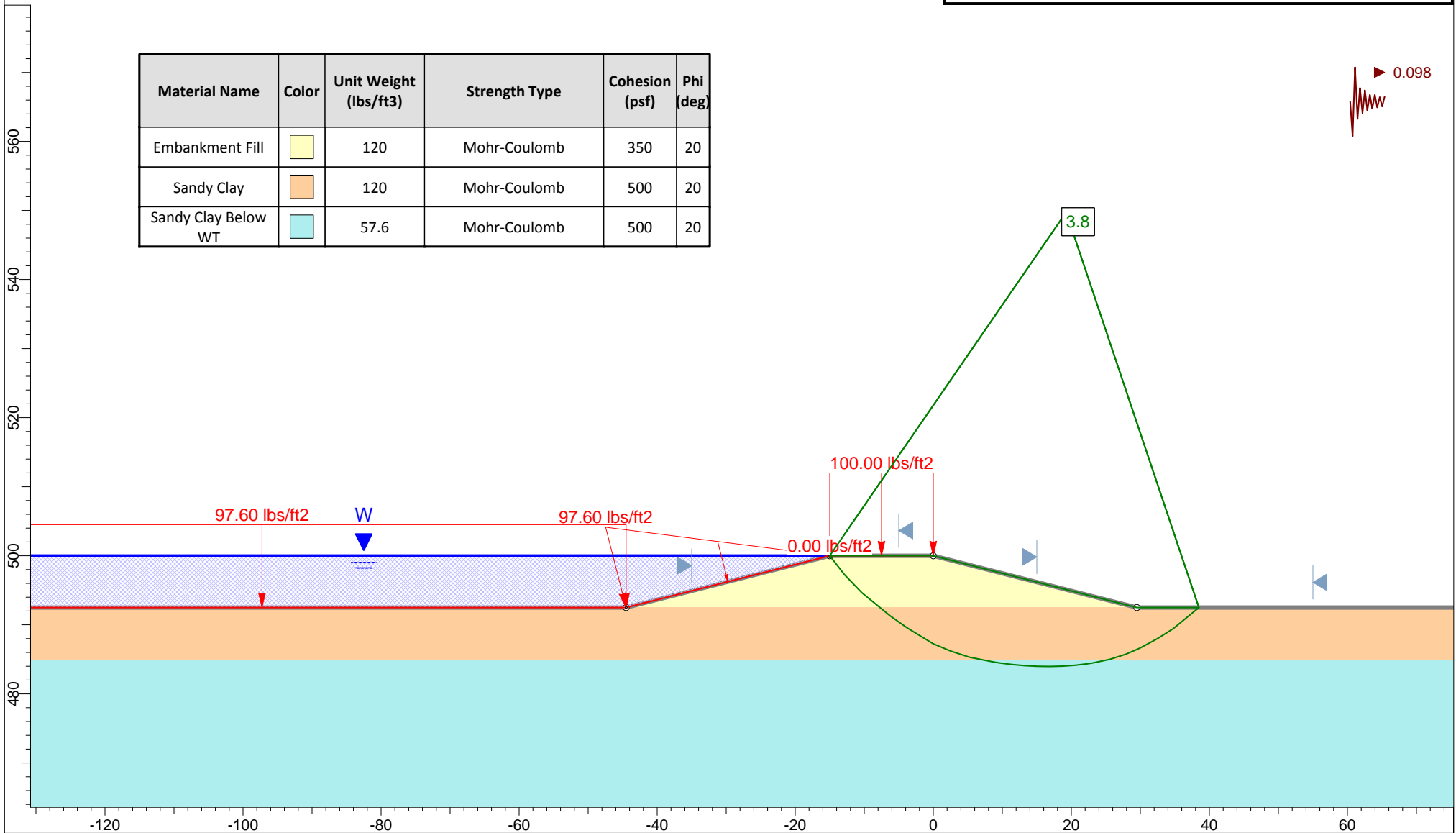

Profile "K" - Maximum Pool
Ash Pond Berms - Spruce/Deely Generation Units

Raba Kistner Consultants, Inc.
ASA12-098-00

Figure D-38a



Global Stability Analysis

Material Name	Color	Unit Weight (lbs/ft ³)	Strength Type	Cohesion (psf)	Phi (deg)
Embankment Fill	Yellow	120	Mohr-Coulomb	350	20
Sandy Clay	Orange	120	Mohr-Coulomb	500	20
Sandy Clay Below WT	Light Blue	57.6	Mohr-Coulomb	500	20

◀ 0.098

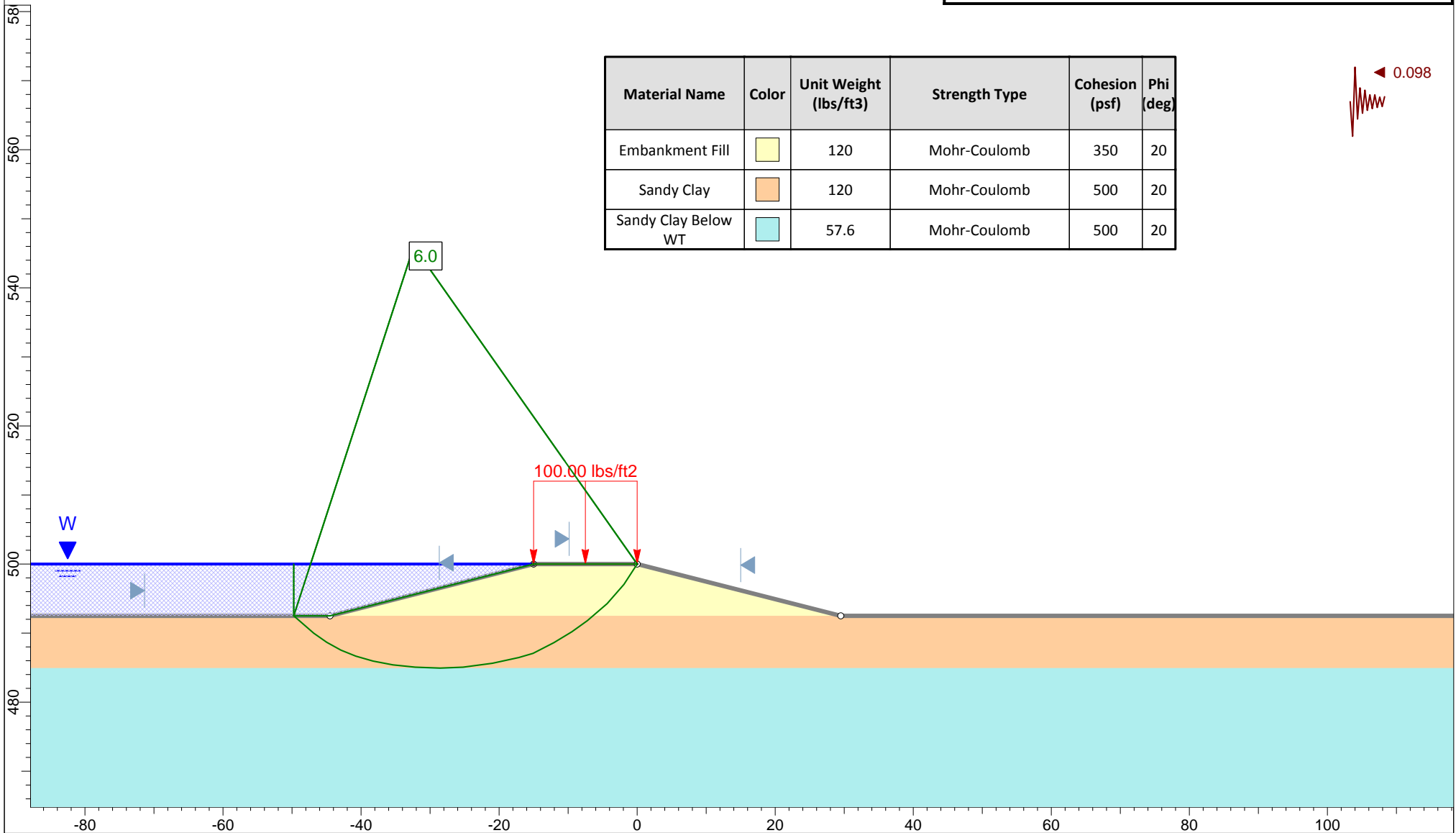





Profile "K" - Maximum Pool
Ash Pond Berms - Spruce/Deely Generation Units

Raba Kistner Consultants, Inc.
ASA12-098-00

Figure D-38b



Global Stability Analysis

Material Name	Color	Unit Weight (lbs/ft ³)	Strength Type	Cohesion (psf)	Phi (deg)
Embankment Fill		120	Mohr-Coulomb	350	20
Clayey Sand		120	Mohr-Coulomb	400	20
Clayey Sand Below WT		57.6	Mohr-Coulomb	400	20
Sandy Clay Below WT		57.6	Mohr-Coulomb	500	20

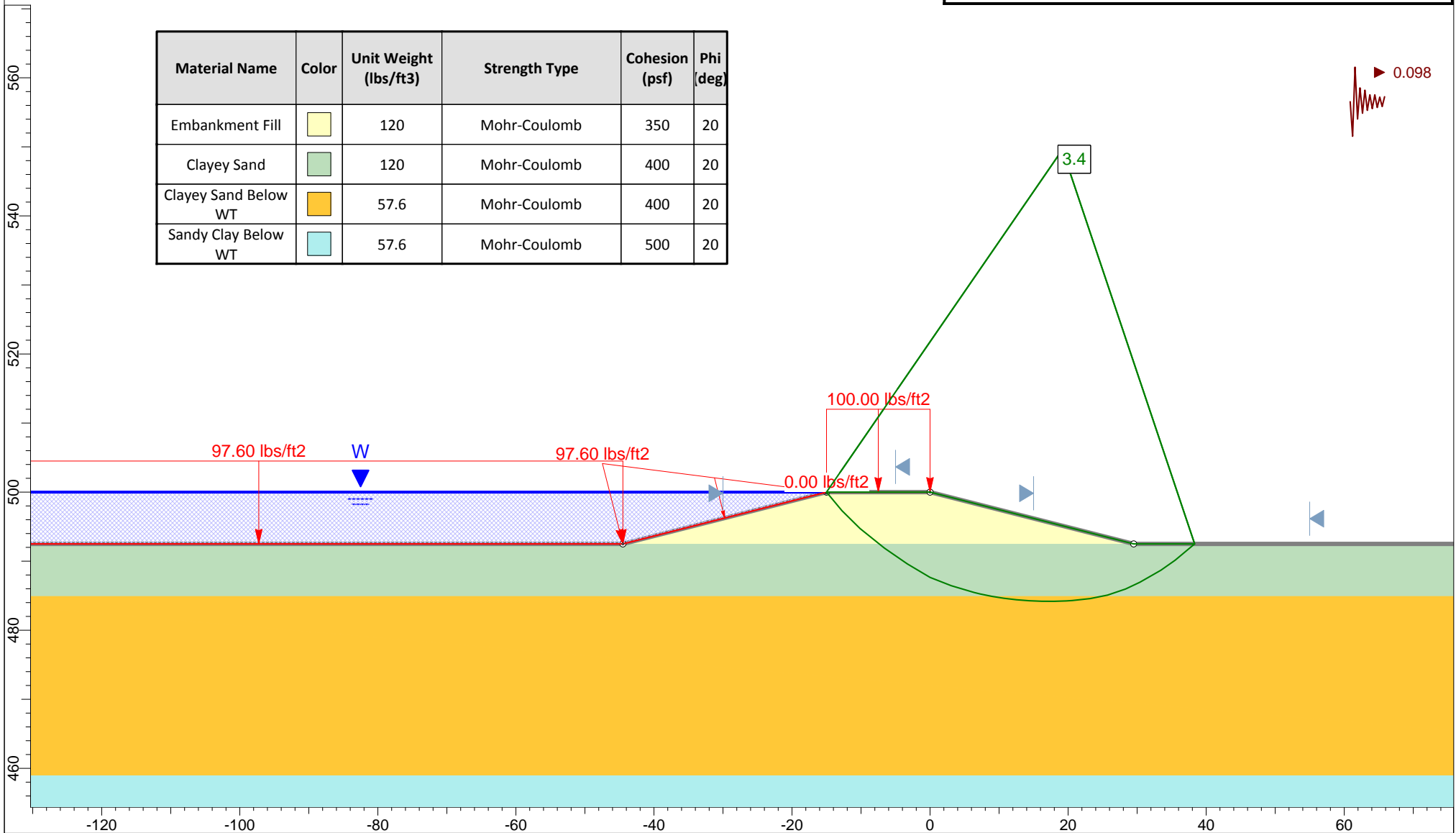

Profile "L" - Maximum Pool
Ash Pond Berms - Spruce/Deely Generation Units

Raba Kistner Consultants, Inc.
ASA12-098-00

Figure D-39a



Global Stability Analysis

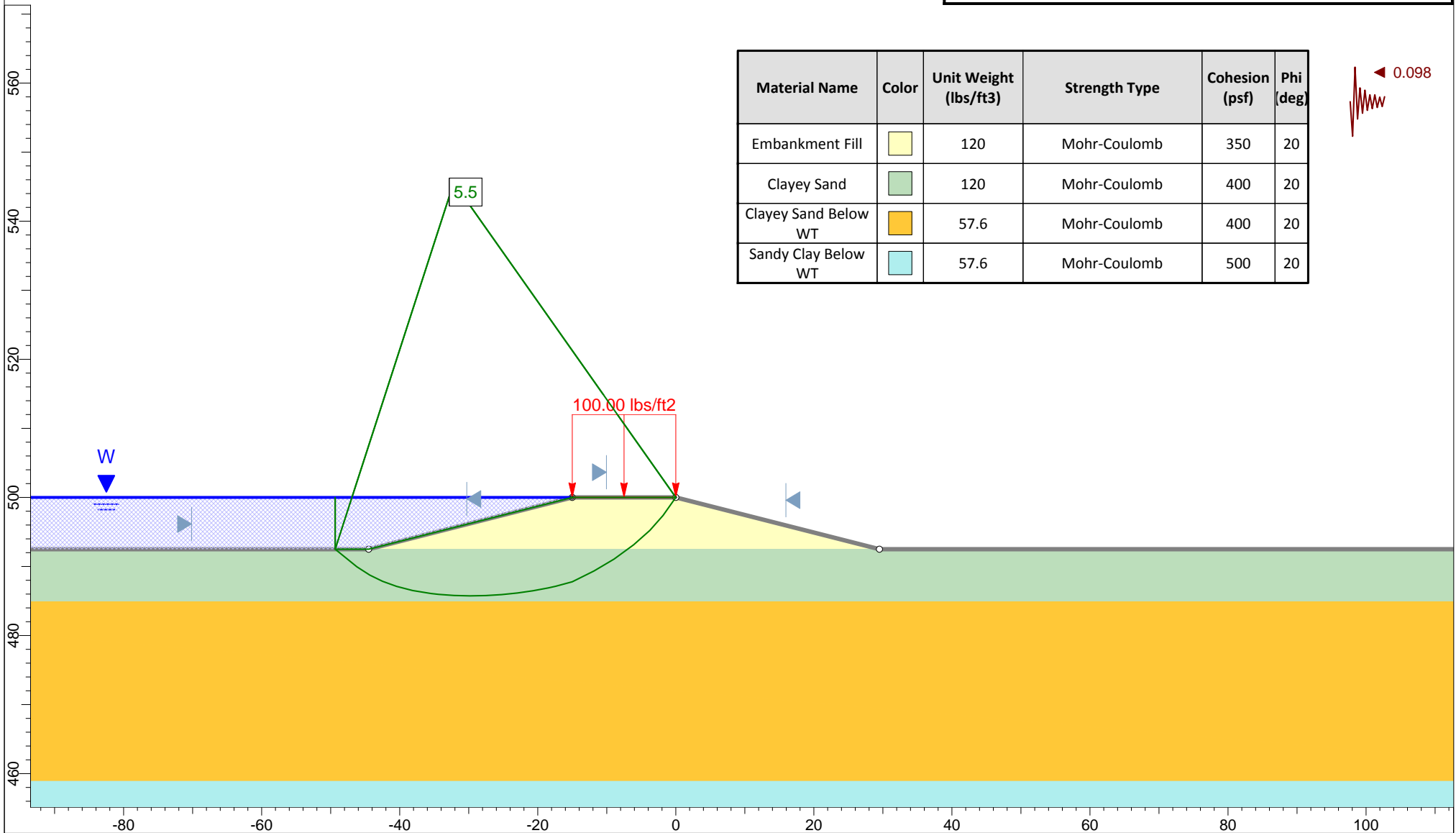





Profile "L" - Maximum Pool
Ash Pond Berms - Spruce/Deely Generation Units

Raba Kistner Consultants, Inc.
ASA12-098-00

Figure D-39b



Global Stability Analysis

Material Name	Color	Unit Weight (lbs/ft ³)	Strength Type	Cohesion (psf)	Phi (deg)
Embankment Fill		120	Mohr-Coulomb	350	20
Sandy Clay		120	Mohr-Coulomb	500	20
Clayey Sand Below WT		57.6	Mohr-Coulomb	400	20
Sandy Clay Below WT		57.6	Mohr-Coulomb	500	20

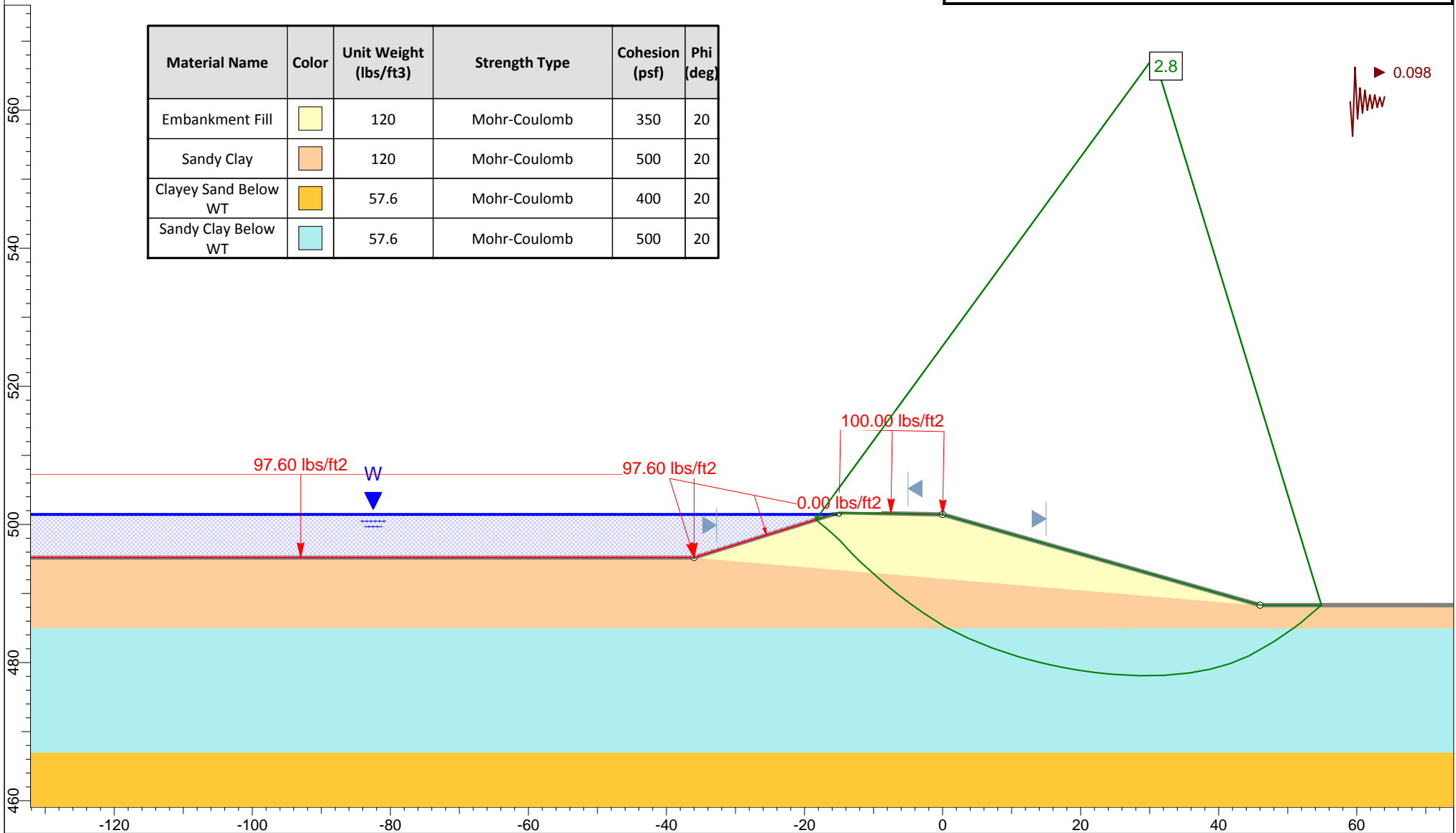





Profile "M" - Maximum Pool
Ash Pond Berms - Spruce/Deely Generation Units

Raba Kistner Consultants, Inc.
ASA12-098-00

Figure D-40a



Global Stability Analysis

Material Name	Color	Unit Weight (lbs/ft ³)	Strength Type	Cohesion (psf)	Phi (deg)
Embankment Fill		120	Mohr-Coulomb	350	20
Sandy Clay		120	Mohr-Coulomb	500	20
Clayey Sand Below WT		57.6	Mohr-Coulomb	400	20
Sandy Clay Below WT		57.6	Mohr-Coulomb	500	20

◀ 0.098

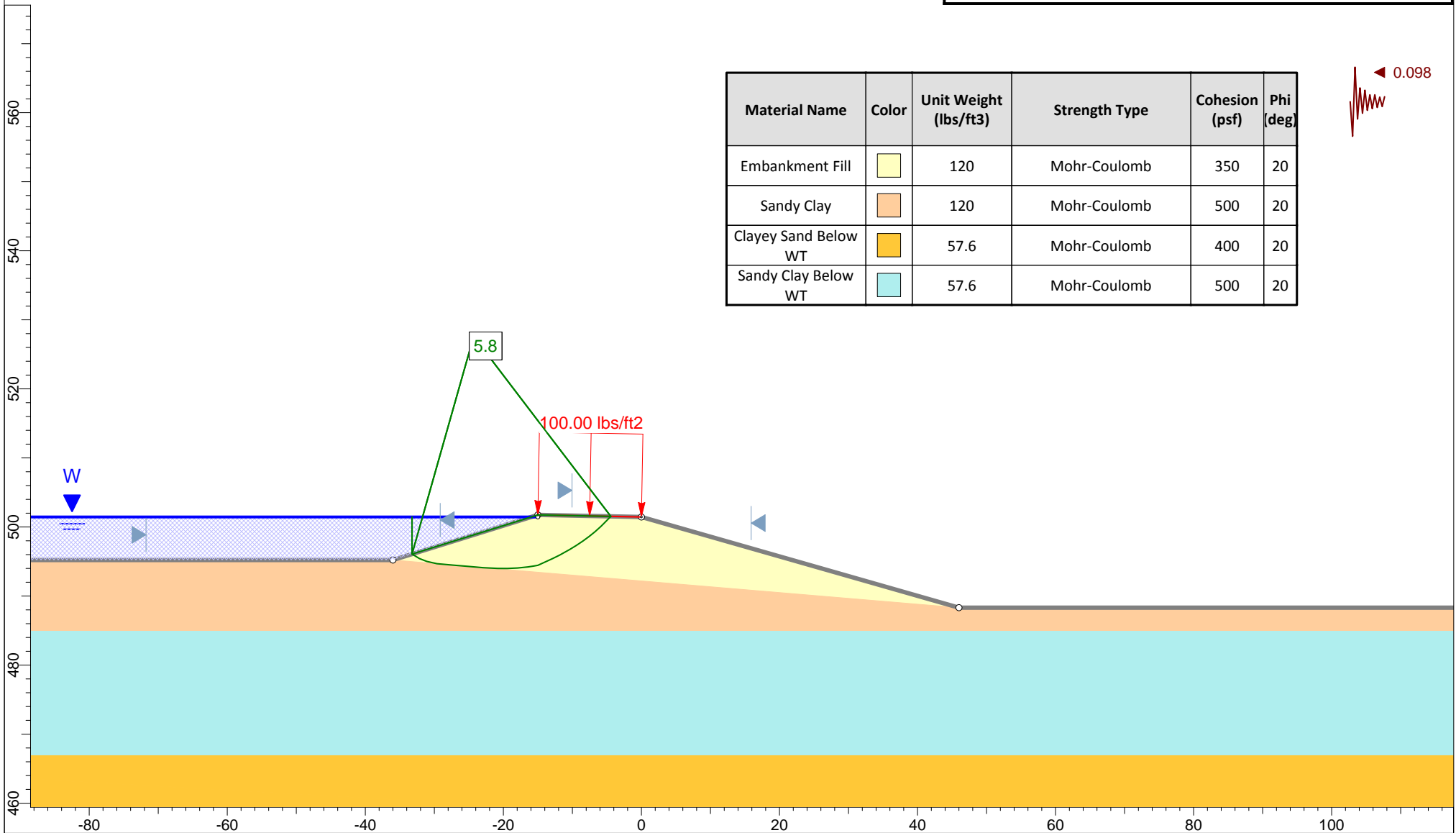

Profile "M" - Maximum Pool
Ash Pond Berms - Spruce/Deely Generation Units

Raba Kistner Consultants, Inc.
ASA12-098-00

Figure D-40b



Global Stability Analysis

Material Name	Color	Unit Weight (lbs/ft ³)	Strength Type	Cohesion (psf)	Phi (deg)
Embankment Fill		120	Mohr-Coulomb	350	20
Clayey Sand		120	Mohr-Coulomb	400	20
Clayey Sand Below WT		57.6	Mohr-Coulomb	400	20

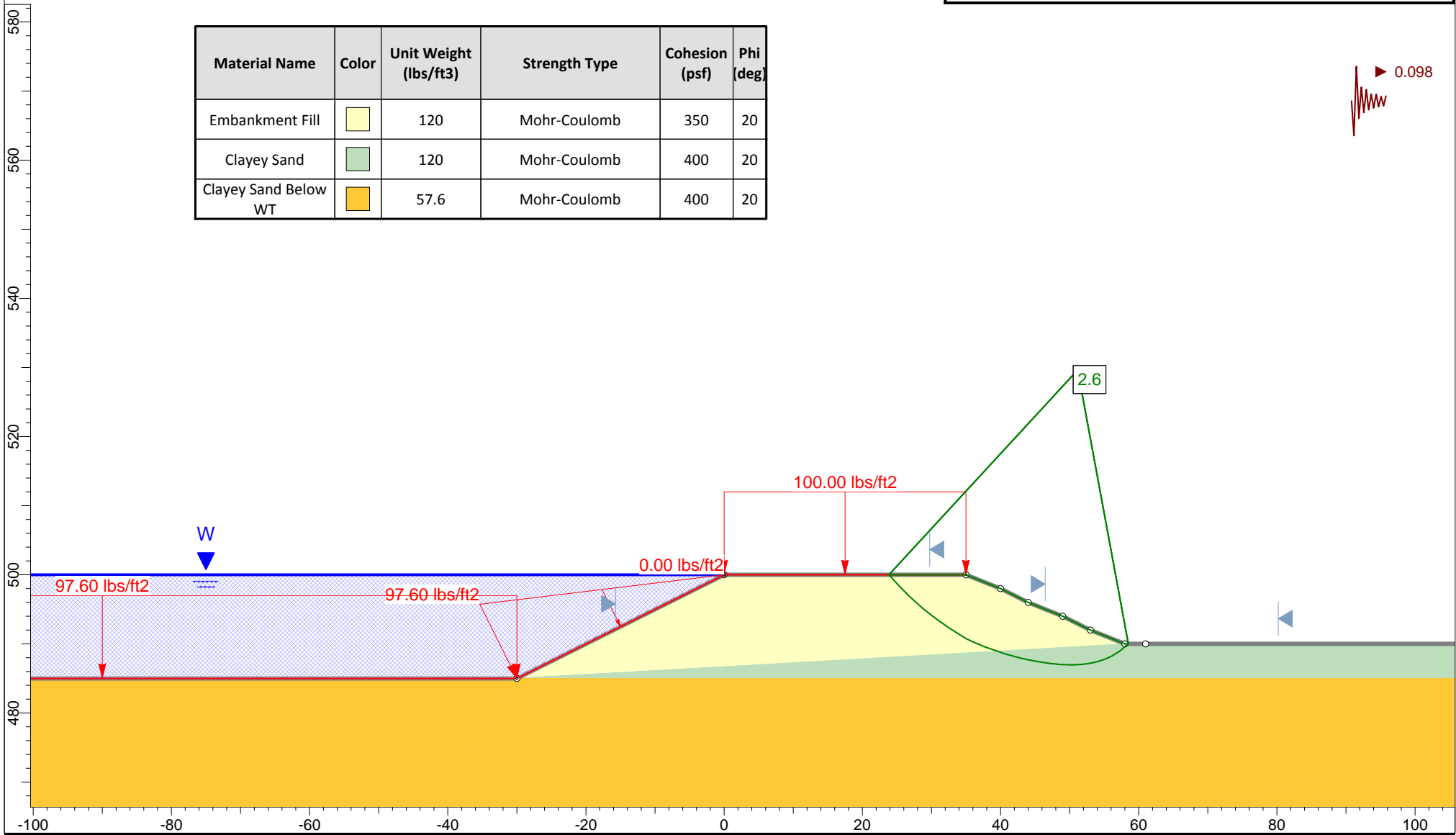

Profile "N" - Maximum Pool
Ash Pond Berms - Spruce/Deely Generation Units

Raba Kistner Consultants, Inc.
ASA12-098-00

Figure D-41a



Global Stability Analysis

Material Name	Color	Unit Weight (lbs/ft ³)	Strength Type	Cohesion (psf)	Phi (deg)
Embankment Fill	Yellow	120	Mohr-Coulomb	350	20
Clayey Sand	Green	120	Mohr-Coulomb	400	20
Clayey Sand Below WT	Orange	57.6	Mohr-Coulomb	400	20

◀ 0.098

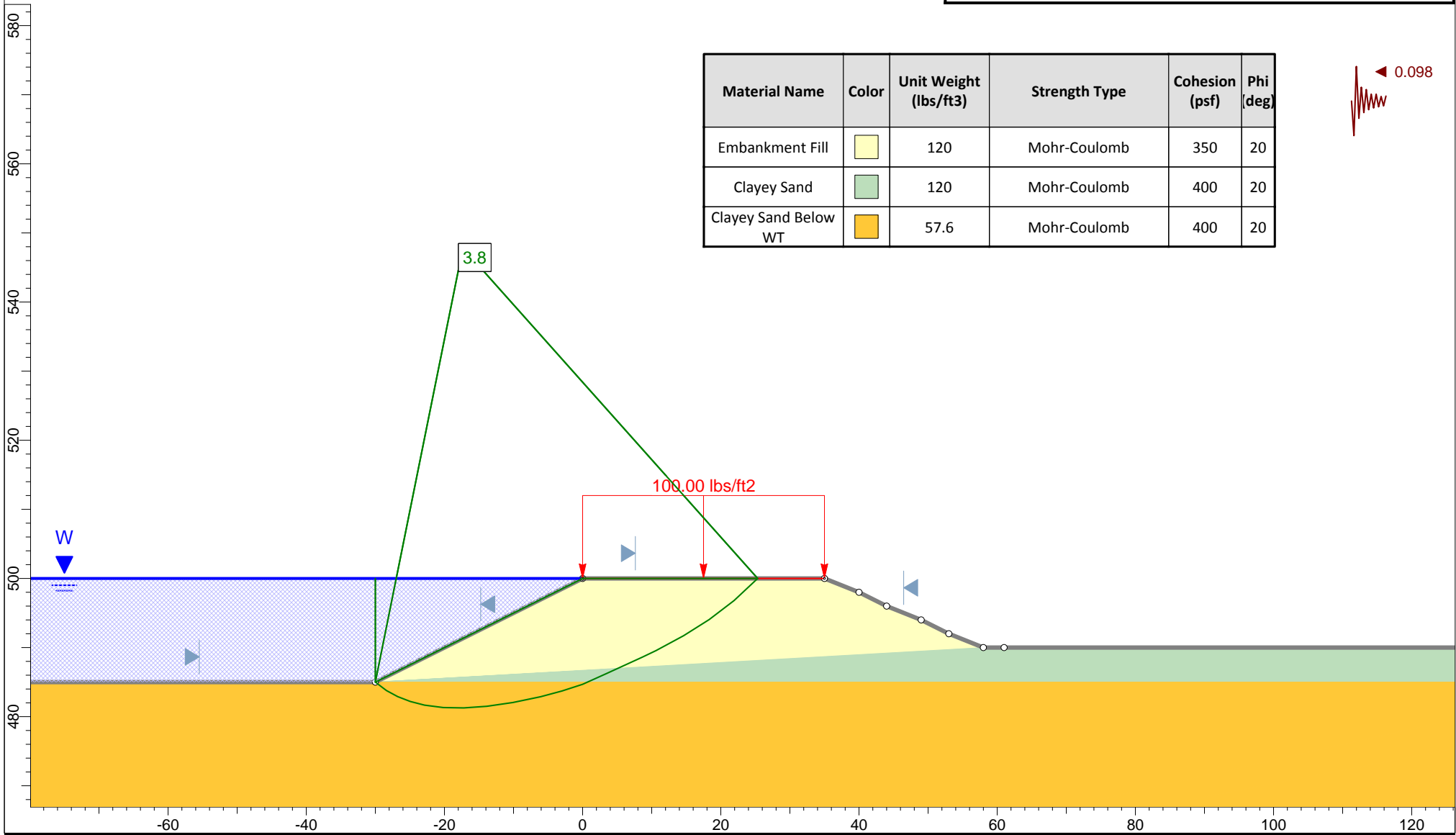

Profile "N" - Maximum Pool
Ash Pond Berms - Calaveras Lake Power Plant

Raba Kistner Consultants, Inc.
ASA12-098-00

Figure D-41b



Appendix B
USEPA Checklists



Site Name: JK Spruce/JT Deely Power Plants	Date: August 28, 2012
Unit Name: Evaporation Pond	Operator's Name: CPS Energy
Unit I.D.:	Hazard Potential Classification: High Significant Low
Inspector's Name: Jamal Daas/Bevin Barringer	

Check the appropriate box below. Provide comments when appropriate. If not applicable or not available, record "N/A". Any unusual conditions or construction practices that should be noted in the comments section. For large diked embankments, separate checklists may be used for different embankment areas. If separate forms are used, identify approximate area that the form applies to in comments.

	<u>Yes</u>	<u>No</u>		<u>Yes</u>	<u>No</u>
1. Frequency of Company's Dam Inspections?		none	18. Sloughing or bulging on slopes?		X
2. Pool elevation (operator records)?		N/A	19. Major erosion or slope deterioration?		X
3. Decant inlet elevation (operator records)?		DNA	20. Decant Pipes:		
4. Open channel spillway elevation (operator records)?		DNA	Is water entering inlet, but not exiting outlet?	DNA	
5. Lowest dam crest elevation (operator records)?		N/A	Is water exiting outlet, but not entering inlet?	DNA	
6. If instrumentation is present, are readings recorded (operator records)?		DNA	Is water exiting outlet flowing clear?	DNA	
7. Is the embankment currently under construction?		X	21. Seepage (specify location, if seepage carries fines, and approximate seepage rate below):		
8. Foundation preparation (remove vegetation, stumps, topsoil in area where embankment fill will be placed)?		N/A	From underdrain?	DNA	
9. Trees growing on embankment? (If so, indicate largest diameter below)		X	At isolated points on embankment slopes?		X
10. Cracks or scarps on crest?		X	At natural hillside in the embankment area?		X
11. Is there significant settlement along the crest?		X	Over widespread areas?		X
12. Are decant trashracks clear and in place?		DNA	From downstream foundation area?		X
13. Depressions or sinkholes in tailings surface or whirlpool in the pool area?		X	"Boils" beneath stream or ponded water?		X
14. Clogged spillways, groin or diversion ditches?		DNA	Around the outside of the decant pipe?	DNA	
15. Are spillway or ditch linings deteriorated?		DNA	22. Surface movements in valley bottom or on hillside?		X
16. Are outlets of decant or underdrains blocked?		DNA	23. Water against downstream toe?		X
17. Cracks or scarps on slopes?		X	24. Were Photos taken during the dam inspection?	X	

Major adverse changes in these items could cause instability and should be reported for further evaluation. Adverse conditions noted in these items should normally be described (extent, location, volume, etc.) in the space below and on the back of this sheet.

<u>Inspection Issue #</u>	<u>Comments</u>
1.	No formal inspections are performed.
2., 5., 8.	No construction drawings or design information was provided for this pond. The evaporation pond was constructed on top of a capped fly ash storage pond, based on information provided by CPS. The evaporation pond has no inlets or outlets. All material is brought in by truck for dewatering.
3., 4., 12., 14., 15., 16., 20., 21.	There are no inlets or outlets.
9.	Largest tree diameter is approximately 6 inches in diameter.



Coal Combustion Waste (CCW) Impoundment Inspection

Impoundment NPDES Permit # WQ0001514000
Date August 28, 2012

INSPECTOR Jamal Daas/Bevin Barringer

Impoundment Name Evaporation Pond
Impoundment Company CPS Energy

EPA Region 6

State Agency (Field Office) Address Texas Commission on Environmental Quality
12110 Park 35 Circle, Austin, TX 78753

Name of Impoundment Evaporation Pond
(Report each impoundment on a separate form under the same Impoundment NPDES Permit number)

New [x] Update

Is impoundment currently under construction? Yes No
Is water or ccw currently being pumped into the impoundment? Yes No

IMPOUNDMENT FUNCTION: Used to dewater scrubber waste.

Nearest Downstream Town: Name Elmendorf, TX

Distance from the impoundment 4.5 miles

Impoundment

Location: Longitude 98 Degrees 18 Minutes 53 Seconds
Latitude 29 Degrees 19 Minutes 27 Seconds
State TX County Bexar

Does a state agency regulate this impoundment? YES [x] NO

If So Which State Agency? Texas Commission on Environmental Quality

HAZARD POTENTIAL (In the event the impoundment should fail, the following would occur):

 LESS THAN LOW HAZARD POTENTIAL: Failure or misoperation of the dam results in no probable loss of human life or economic or environmental losses.

 x **LOW HAZARD POTENTIAL:** Dams assigned the low hazard potential classification are those where failure or misoperation results in no probable loss of human life and low economic and/or environmental losses. Losses are principally limited to the owner’s property.

 SIGNIFICANT HAZARD POTENTIAL: Dams assigned the significant hazard potential classification are those dams where failure or misoperation results in no probable loss of human life but can cause economic loss, environmental damage, disruption of lifeline facilities, or can impact other concerns. Significant hazard potential classification dams are often located in predominantly rural or agricultural areas but could be located in areas with population and significant infrastructure.

 HIGH HAZARD POTENTIAL: Dams assigned the high hazard potential classification are those where failure or misoperation will probably cause loss of human life.

DESCRIBE REASONING FOR HAZARD RATING CHOSEN:

Failure or misoperation of the impoundment would likely result in damage to CPS property. Liquids would flow into Calaveras Lake which was constructed by and is owned by CPS Energy.

CONFIGURATION:

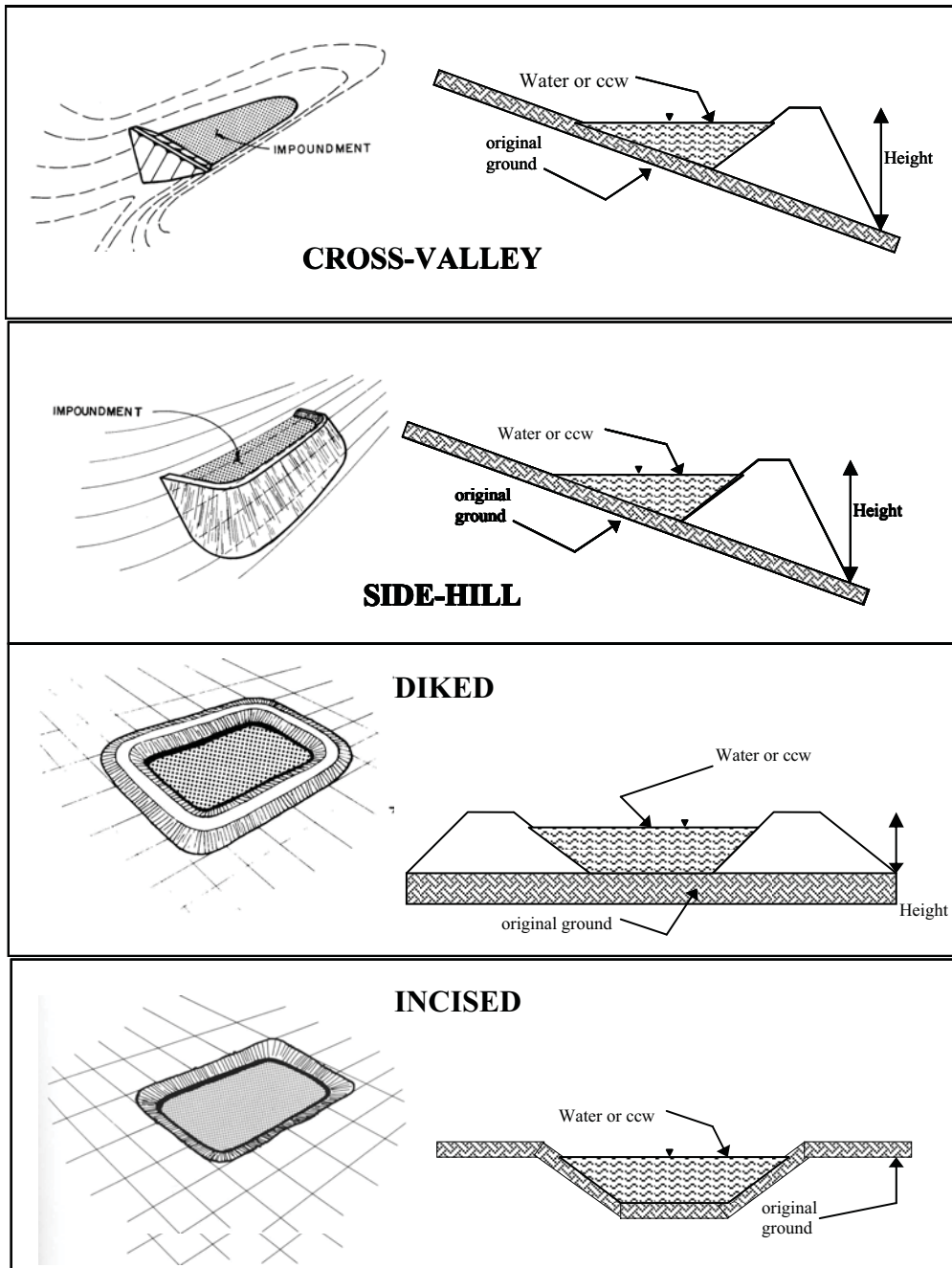

- Cross-Valley
- Side-Hill
- Diked
- Incised (form completion optional)
- Combination Incised/Diked

Embankment Height 15* feet Embankment Material unknown
 Pool Area 4.5 acres Liner PVC
 Current Freeboard 2* feet Liner Permeability unknown

*Because information was not provided on this pond, embankment height and current freeboard were estimated during the assessment.

TYPE OF OUTLET (Mark all that apply)

 Open Channel Spillway

- Trapezoidal
- Triangular
- Rectangular
- Irregular

- depth
- bottom (or average) width
- top width

TRAPEZOIDAL

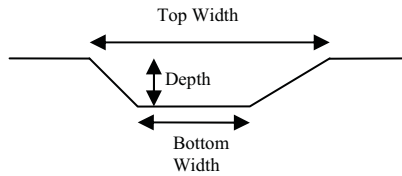

TRIANGULAR

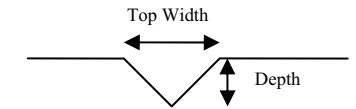

RECTANGULAR

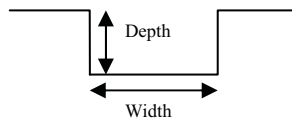

IRREGULAR

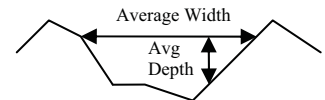

 Outlet

 inside diameter

Material

- corrugated metal
- welded steel
- concrete
- plastic (hdpe, pvc, etc.)
- other (specify) _____

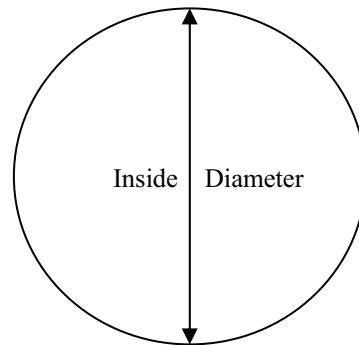

Is water flowing through the outlet? YES _____ NO _____

 X **No Outlet**

 Other Type of Outlet (specify) _____

The Impoundment was Designed By unknown _____

Has there ever been a failure at this site? YES _____ NO x

If So When? _____

If So Please Describe : _____

Lined area for description with 22 horizontal lines.

Has there ever been significant seepages at this site? YES _____ NO X

If So When? _____

IF So Please Describe: _____

Multiple horizontal lines for providing a detailed description of seepage events.



ADDITIONAL INSPECTION QUESTIONS

Concerning the embankment foundation, was the embankment construction built over wet ash, slag, or other unsuitable materials? If there is no information just note that.

The Evaporation Pond embankments were constructed on top of an area that had previously been used as a fly ash landfill and as a fly ash impoundment. Boring logs for subsurface investigations performed at the Evaporation Pond in 2012 by Raba Kistner Consultants, Inc., did not encounter CCW or other unsuitable materials per project boring logs.

Did the dam assessor meet with, or have documentation from, the design Engineer-of-Record concerning the foundation preparation?

The assessor did not meet with, or have documentation from, the design Engineer of Record concerning foundation preparation.

From the site visit or from photographic documentation, was there evidence of prior releases, failures, or patchwork on the dikes?

There was no indication of prior releases, failures or patchwork on the embankments.



Site Name: JK Spruce Power Plant	Date: August 27, 2012
Unit Name: SRH Pond	Operator's Name: CPS Energy
Unit I.D.:	Hazard Potential Classification: High Significant Low
Inspector's Name: Jamal Daas/Bevin Barringer	

Check the appropriate box below. Provide comments when appropriate. If not applicable or not available, record "N/A". Any unusual conditions or construction practices that should be noted in the comments section. For large diked embankments, separate checklists may be used for different embankment areas. If separate forms are used, identify approximate area that the form applies to in comments.

	Yes	No		Yes	No
1. Frequency of Company's Dam Inspections?		none	18. Sloughing or bulging on slopes?		X
2. Pool elevation (operator records)?		495.0	19. Major erosion or slope deterioration?		X
3. Decant inlet elevation (operator records)?		492.5	20. Decant Pipes:		
4. Open channel spillway elevation (operator records)?		499.5	Is water entering inlet, but not exiting outlet?	X	
5. Lowest dam crest elevation (operator records)?		500.0	Is water exiting outlet, but not entering inlet?		X
6. If instrumentation is present, are readings recorded (operator records)?	DNA		Is water exiting outlet flowing clear?	DNA	
7. Is the embankment currently under construction?		X	21. Seepage (specify location, if seepage carries fines, and approximate seepage rate below):		
8. Foundation preparation (remove vegetation, stumps, topsoil in area where embankment fill will be placed)?	X		From underdrain?	DNA	
9. Trees growing on embankment? (If so, indicate largest diameter below)		X	At isolated points on embankment slopes?		X
10. Cracks or scarps on crest?		X	At natural hillside in the embankment area?		X
11. Is there significant settlement along the crest?		X	Over widespread areas?		X
12. Are decant trashracks clear and in place?		X	From downstream foundation area?		X
13. Depressions or sinkholes in tailings surface or whirlpool in the pool area?		X	"Boils" beneath stream or ponded water?		X
14. Clogged spillways, groin or diversion ditches?		X	Around the outside of the decant pipe?		X
15. Are spillway or ditch linings deteriorated?		X	22. Surface movements in valley bottom or on hillside?		X
16. Are outlets of decant or underdrains blocked?	see	note	23. Water against downstream toe?	X	
17. Cracks or scarps on slopes?		X	24. Were Photos taken during the dam inspection?	X	

Major adverse changes in these items could cause instability and should be reported for further evaluation. Adverse conditions noted in these items should normally be described (extent, location, volume, etc.) in the space below and on the back of this sheet.

<u>Inspection Issue #</u>	<u>Comments</u>
1.	No formal inspections are performed.
2.	No plant water level measurements were provided. Pool level estimated during assessment.
12.	No trashracks were observed.
16.	Outlet pipes were submerged during assessment.
23.	Fly Ash Pond - South is located at the east embankment exterior slope. A concrete lined drainage ditch is located at the south embankment exterior toe. The #1 Stormwater Runoff Pond is located at the north embankment exterior toe.

N/A=not available
DNA=does not apply



Coal Combustion Waste (CCW) Impoundment Inspection

Impoundment NPDES Permit # WQ0001514000
Date August 27, 2012

INSPECTOR Jamal Daas/Bevin Barringer

Impoundment Name SRH Pond
Impoundment Company CPS Energy
EPA Region 6
State Agency (Field Office) Address Texas Commission on Environmental Quality
12110 Park 35 Circle, Austin, TX 78753

Name of Impoundment SRH Pond
(Report each impoundment on a separate form under the same Impoundment NPDES Permit number)

New [x] Update

Is impoundment currently under construction? Yes No
Is water or ccw currently being pumped into the impoundment? X

Stores stormwater from material storage, low volume waste, quench water, flue gas

IMPOUNDMENT FUNCTION: desulphurization scrubber sludge, and metal cleaning waste.

Nearest Downstream Town: Name Elmendorf, TX
Distance from the impoundment 3.5 miles

Impoundment Location: Longitude 98 Degrees 19 Minutes 5 Seconds
Latitude 29 Degrees 18 Minutes 28 Seconds
State TX County Bexar

Does a state agency regulate this impoundment? YES [x] NO

If So Which State Agency? Texas Commission on Environmental Quality

HAZARD POTENTIAL (In the event the impoundment should fail, the following would occur):

_____ **LESS THAN LOW HAZARD POTENTIAL:** Failure or misoperation of the dam results in no probable loss of human life or economic or environmental losses.

_____ **LOW HAZARD POTENTIAL:** Dams assigned the low hazard potential classification are those where failure or misoperation results in no probable loss of human life and low economic and/or environmental losses. Losses are principally limited to the owner’s property.

X _____ **SIGNIFICANT HAZARD POTENTIAL:** Dams assigned the significant hazard potential classification are those dams where failure or misoperation results in no probable loss of human life but can cause economic loss, environmental damage, disruption of lifeline facilities, or can impact other concerns. Significant hazard potential classification dams are often located in predominantly rural or agricultural areas but could be located in areas with population and significant infrastructure.

_____ **HIGH HAZARD POTENTIAL:** Dams assigned the high hazard potential classification are those where failure or misoperation will probably cause loss of human life.

DESCRIBE REASONING FOR HAZARD RATING CHOSEN:

Failure or misoperation of the impoundment could result in fluid flowing toward the plant facility located approximately 100 feet west of the SRH Pond which could result in economic loss and disruption of lifeline facilities.

CONFIGURATION:

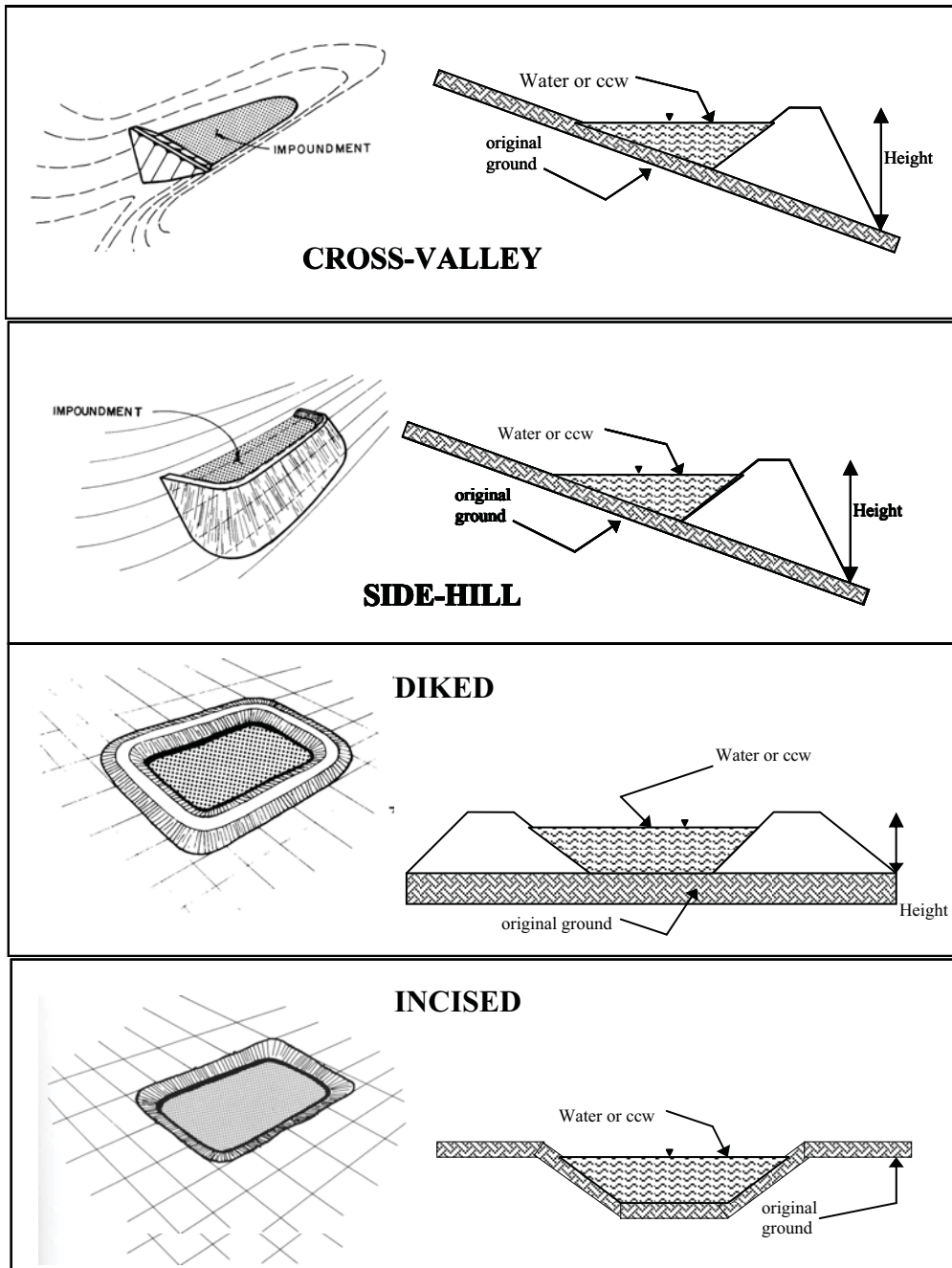

- Cross-Valley
- Side-Hill
- Diked
- Incised (form completion optional)
- Combination Incised/Diked

Embankment Height 8 feet Embankment Material Clay
 Pool Area 3.5 acres Liner 30 mil HDPE liner
 Current Freeboard 5 feet Liner Permeability N/A

TYPE OF OUTLET (Mark all that apply)

 Open Channel Spillway

- Trapezoidal
- Triangular
- Rectangular
- Irregular

- depth
- bottom (or average) width
- top width

TRAPEZOIDAL

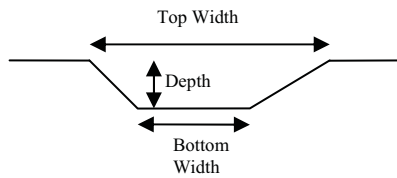

TRIANGULAR

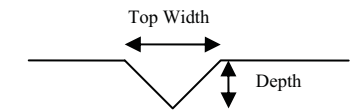

RECTANGULAR

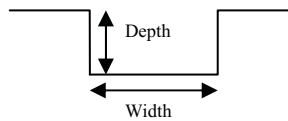

IRREGULAR

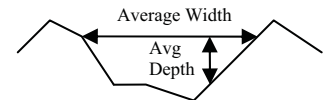

 X **Outlet**

 18" inside diameter

Material

- corrugated metal
- X welded steel
- concrete
- plastic (hdpe, pvc, etc.)
- other (specify) _____

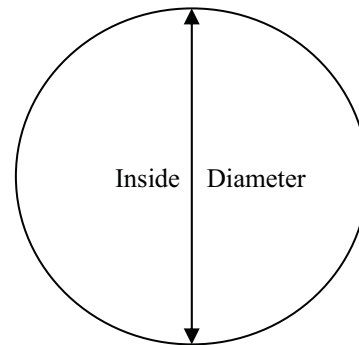

Is water flowing through the outlet? YES _____ NO X

 No Outlet

 Other Type of Outlet (specify) _____

The Impoundment was Designed By Utility Engineering Corporation

**ADDITIONAL INSPECTION QUESTIONS**

Concerning the embankment foundation, was the embankment construction built over wet ash, slag, or other unsuitable materials? If there is no information just note that.

It does not appear the SRH Pond was constructed over wet ash, slag or other unsuitable material. The SRH Pond was constructed in 1992. No historical subsurface soil information in the vicinity of the SRH Pond was provided. Borings performed in 2012 by RKCI indicate that the embankments consist of sandy clay and clayey sand fill material, and underlying native material consists of sandy clay and clayey sand with isolated tan and gray clay seams.

Did the dam assessor meet with, or have documentation from, the design Engineer-of-Record concerning the foundation preparation?

The assessor did not meet with, or have documentation from, the design Engineer of Record concerning foundation preparation.

From the site visit or from photographic documentation, was there evidence of prior releases, failures, or patchwork on the dikes?

There was no indication of prior releases, failures or patchwork on the embankments.

Appendix C
Documentation from CPS

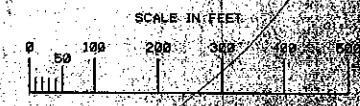
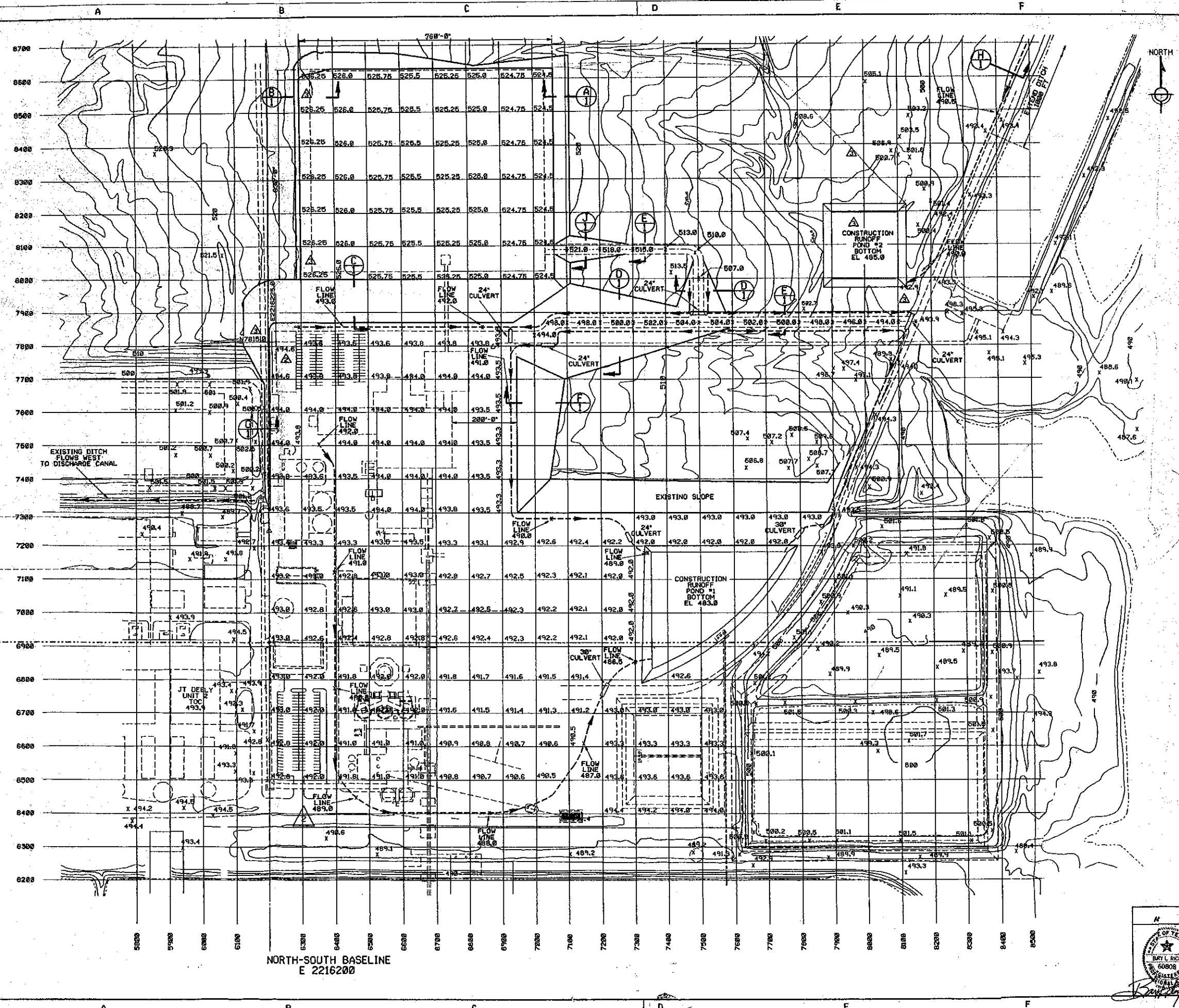

GENERAL NOTES

1. PLANT ELEVATION 100 FT = 40' HORIZ.
2. ALL SITE FILL SHALL BE CONTROLLED AND COMPACTED FILL.
3. --- INDICATES A DITCH AND DIRECTION OF FLOW.
4. DITCHES SHALL BE CONSTRUCTED TO A MINIMUM SLOPE BETWEEN FLOW LINE OBSERVATIONS INDICATED. CONTRACTOR SHALL MAINTAIN ALL DITCHES DRAIN THROUGHOUT CONSTRUCTION RUNOFF PONDS.
5. CONTRACTOR SHALL INSURE THAT THE COURSE OF CONSTRUCTION ALONG SUBWAY RUNOFF FROM AREAS WITH DISTURBED SOILS TEMPORARY FACILITIES, LAYDOWN AND CONSTRUCTION SHALL DRAIN INTO ONE OF THE TWO CONSTRUCTION RUNOFF PONDS.
6. GRADES GIVEN ARE TOP OF FINISHED CONSTRUCTION SUBGRADE.
7. TOP OF SLAB ELEVATIONS FOR MAJOR STRUCTURES OF UNIT 1) SHALL BE:
 OFFICE BUILDING 499.0
 TURBINE BUILDING 498.0
 MAINTENANCE BUILDING 497.0
 BOILER BUILDING 496.0
 BAGHOUSE 495.0
 SCRUBBER 494.0
 AGCS BUILDING 493.0
8. CULVERTS SHALL BE REINFORCED CONCRETE PIPE CLASS III DESIGN.
9. SOILS EXCAVATED FROM THIS AREA SHALL BE USED AS FILL OR STOCKPILED FOR USE AS FILL IF IT IS FREE OF LARGE ROCKS, DRIFT MATERIALS OR DEBRIS.
10. TOP OF CONCRETE SLAB FOR MAJOR STRUCTURES TO BE AT ELEV. 495.0.

REFERENCE DRAWINGS

1. SECTIONS AND DETAILS
 D-CL05-006-8005
2. CONSTRUCTION RUNOFF POND
 D-CL05-158-5001

RECEIVED
 APR 14 1994
 POWER DIVISION

**AS
 CONSTRUCTED**

CITY PUBLIC SERVICE J. K. SPRUCE UNIT I	
UTILITY ENGINEERING DEPARTMENT CONSTRUCTION ENGINEERING SECTION	
SITE PREPARATION CONSTRUCTION GRADES	
DATE: 03-21-94 DRAWN BY: MICHELL	PROJECT NO.: D-CL05-006-8005
SHEET NO. 1 OF 1	

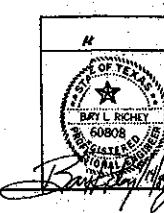

EAST-WEST BASELINE
 N 536915

NORTH-SOUTH BASELINE
 E 2216200

DEVICE TAG NUMBER	SYS TEM	FUNCTION
LS-001	SCS	HLA
LS-002	HVL	LC

FLANGE DATA:

FLANGE
R OR F - RAISED FACE OR FLAT FACE
TYPE OF FLANGE W - WELD NECK
B - BLIND
S - SOCKET WELD
T - THREADED
L - LAP JOINT
O - SLIP ON
R - ORIFICE
PRESSURE RATING
012 - 125"
015 - 150"
030 - 300"
040 - 400"
080 - 800"
090 - 900"
150 - 1500"
250 - 2500"

GENERAL NOTES

- ALL FRP FLANGES SHALL MEET THE STANDARDS FOR ANSI B16.5 150 LB.
- ALL PIPING WITH MATERIAL DESIGNATION "Z" SHALL BE HIGH MOLECULAR WEIGHT, HIGH DENSITY POLYETHYLENE. ALL PIPES SHALL HAVE A MINIMUM WALL THICKNESS EQUIVALENT TO SDR 33.5. JOINTS SHALL BE BY THE BUTT FUSION TECHNIQUE. THE VENDOR SHALL PROVIDE 40 FOOT MINIMUM LENGTHS.
- PROVIDE PVC FABRICATED FLANGE FOR BOLTING SURFACE CUT 2" THICK PVC PLATE TO MATCH STANDARD B16.5 18" FLANGE WITH 25" OD, 17.25" ID WITH 16-1/2" BOLT HOLES ON 22.75" DIAMETER BOLT CIRCLE.
- THE DASHED LINE REPRESENTS A 8" POLYPROPYLENE LINE PIPE THAT IS PROVIDED BY CE ON REF DWG 5.
- PIPE DESIGNATION "U" IS POLYPROPYLENE LINED CARBON STEEL. THE PIPING SHALL MEET ALL REQUIREMENTS SPECIFIED IN SUBSECTION 66.2000M, (D) OF THE CONTRACT. FLANGES SHOWN ON THE LINED PIPE SHALL NOT BE FACED SINCE ALL JOINTS ARE PROVIDED WITH FLANGES.
- CAST IRON FLANGED COUPLING ADAPTER-ROCKWELL INTERNATIONAL-SPECIAL ORDER 912-065006-000. PROVIDE WITH O-RING GASKET FOR FLANGED END & NON-CORROSIVE ANCHOR STUDS. STUD LENGTHS SHALL INCLUDE THE WIDTH OF THE HDP FLANGE ADAPTER END (0.8").

REFERENCE DRAWINGS

- SRH POND SUMP PIPING PLAN AND SECTIONS D-CLOS-464-M100
- SRH CLARIFIER SUPPLY & POND RECYCLE PUMPS 464-8001 (MPR)
- PL10 - DATA BASE
- A-CLOS-464-M001 VALV
- A-CLOS-464-M001 INST
- A-CLOS-464-M001 PIPE
- SLUDGE HANDLING SYSTEM SRH POND SUMP-PLAN, SECT & DETAILS D-CLOS-464-S002
- MISC PIPING-THICKNER AREA 281-1014 (MPR)

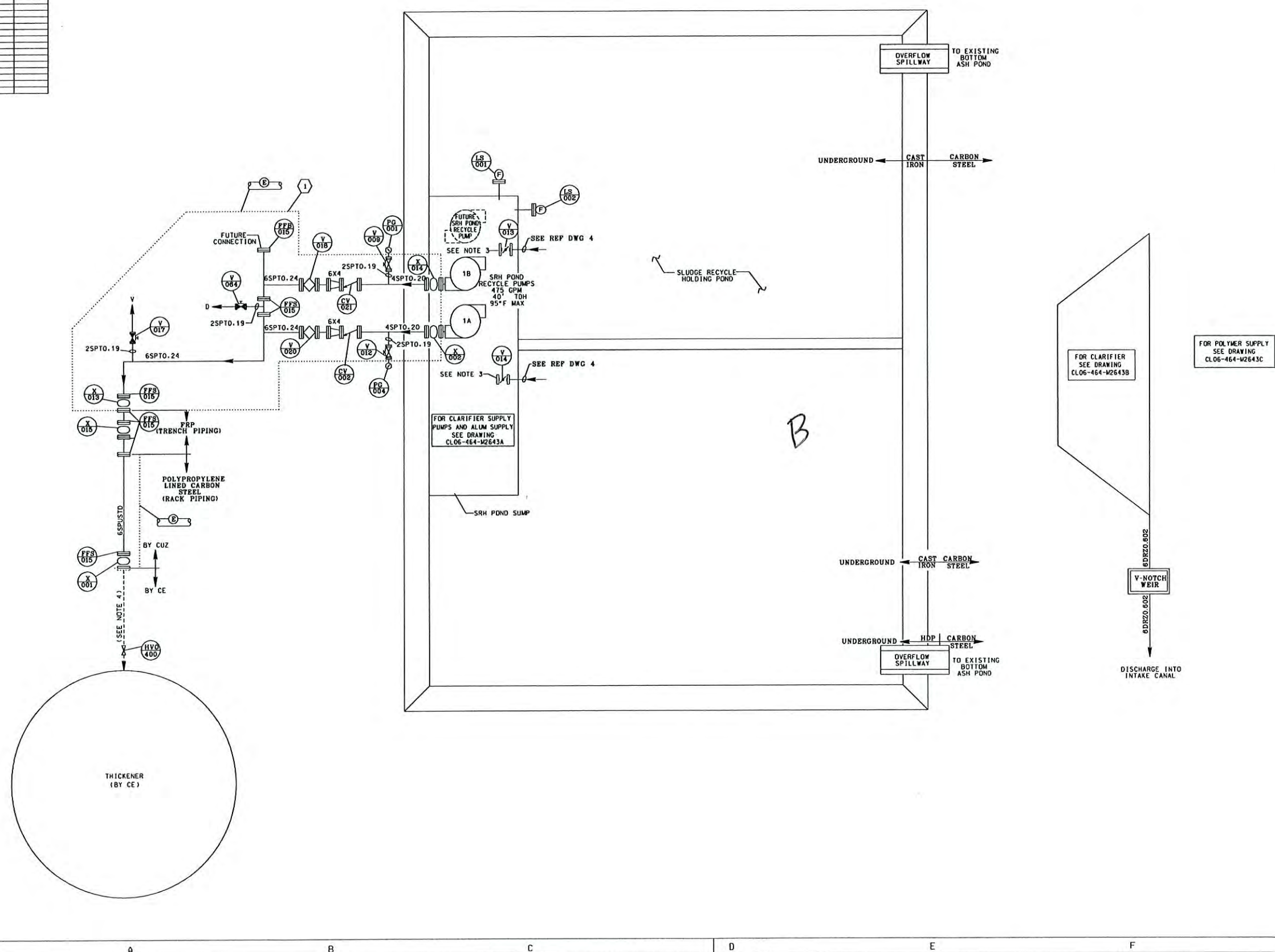

3	CPS JESS DREWS	08/21/91	AWK	1/16				
4	CPS DRIVING REVISION	04/28/93	AWK	1/16				
5	CPS FIELD REVISIONS/ADDED TANK & PUMP	01/19/93	AWK	1/16				
6	ADDED LEVEL SWITCH & A-1 AS NOTED & INSTAL. AROUND VALVE #19 & D-3 & VALVE	12/18/92	AWK	1/16				
7	REV. & PIPING @ A-1-1							
8	ADDED INSTR LEADGE INFO	12/18/91	JJB	1/16				
9	ISSUED FOR CONSTRUCTION	08/27/91	AWK	1/16				
10	REVISIONS							
11	DATE	BY	CHK	DATE	BY	CHK	DATE	BY

THIS DRAWING IS THE PROPERTY OF UTILITY ENGINEERING CORPORATION. IT SHALL BE RETURNED TO THE COMPANY AND IS NOT TO BE REPRODUCED OR USED TO FURNISH ANY INFORMATION FOR THE MAKING OF DRAWINGS OR APPURTENANCES EXCEPT WHERE PROVIDED FOR BY AGREEMENT WITH SAID COMPANY.

**CITY PUBLIC SERVICE
J. K. SPRUCE UNIT 1**

UTILITY ENGINEERING CORPORATION
COMBUSTION ENGINEERING, INC. K.E. BACHRY COMPANY

SLUDGE RECYCLE SYSTEM
PROCESS & INSTRUMENTATION DIAGRAM

REV	ISSUED	DATE	BY	CHK	REVISIONS	DATE	BY	CHK
1	1	08/27/91	AWK	1/16				
2	2	08/27/91	AWK	1/16				
3	3	08/27/91	AWK	1/16				
4	4	08/27/91	AWK	1/16				
5	5	08/27/91	AWK	1/16				

D-CLOS-464-M001 5

GENERAL NOTES
 1. ALL PIPING SHALL BE FIBERGLASS REINFORCED PLASTIC.

REFERENCE DRAWINGS

1. SLUDGE HANDLING SYSTEM - SRH POND PLAN D-CL05-464-S001
2. SLUDGE HANDLING SYSTEM-SRH POND SUMP PLAN D-CL05-464-S002
3. SLUDGE HANDLING SYSTEM-SRH POND PIPE RACK PIPING PLAN D-CL05-051-L-901 SH 2
4. SLUDGE HANDLING SYSTEM-SLUDGE RECYCLE SYSTEM PAID D-CL05-464-M001
5. SRH CLARIFIER SUPPLY & POND RECYCLE PUMPS 464-B001 (MFR)

RECEIVED
 APR 0 1994
 CIVIL ENGINEERING
 AS
 CONSTRUCTED

1. REVISED PLAN & A-1 PER FH 92-143
 2. ISSUED FOR CONSTRUCTION
 DATE BY: CWK/DMR/PPH

**CITY PUBLIC SERVICE
 J. K. SPRUCE UNIT 1**

UTILITY ENGINEERING CORPORATION
 COMBUSTION ENGINEERING, INC. B.B. TEACHER COMPANY
**SLUDGE HANDLING SYSTEM - SRH POND
 SUMP PIPING PLAN AND SECTIONS**
 D-CL05-464-M100

MAR 10 1992

05-MAR-1992 08:43
 C:\WP51\DESIGN\SLUDGE.DWG

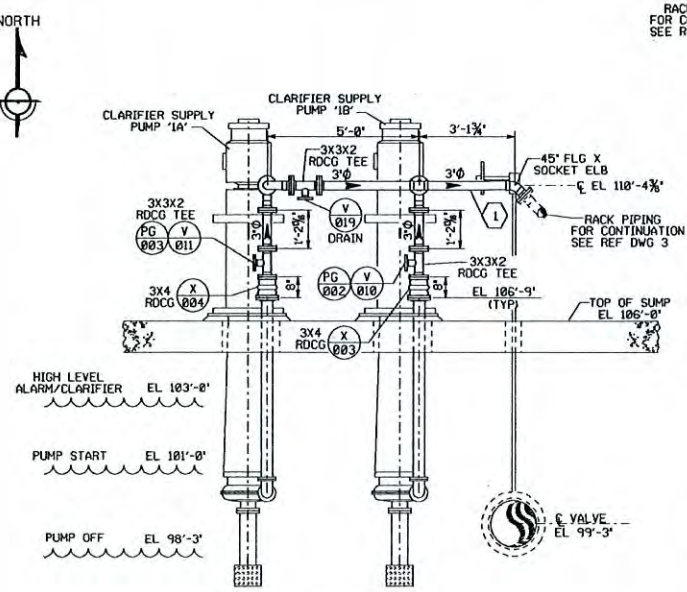
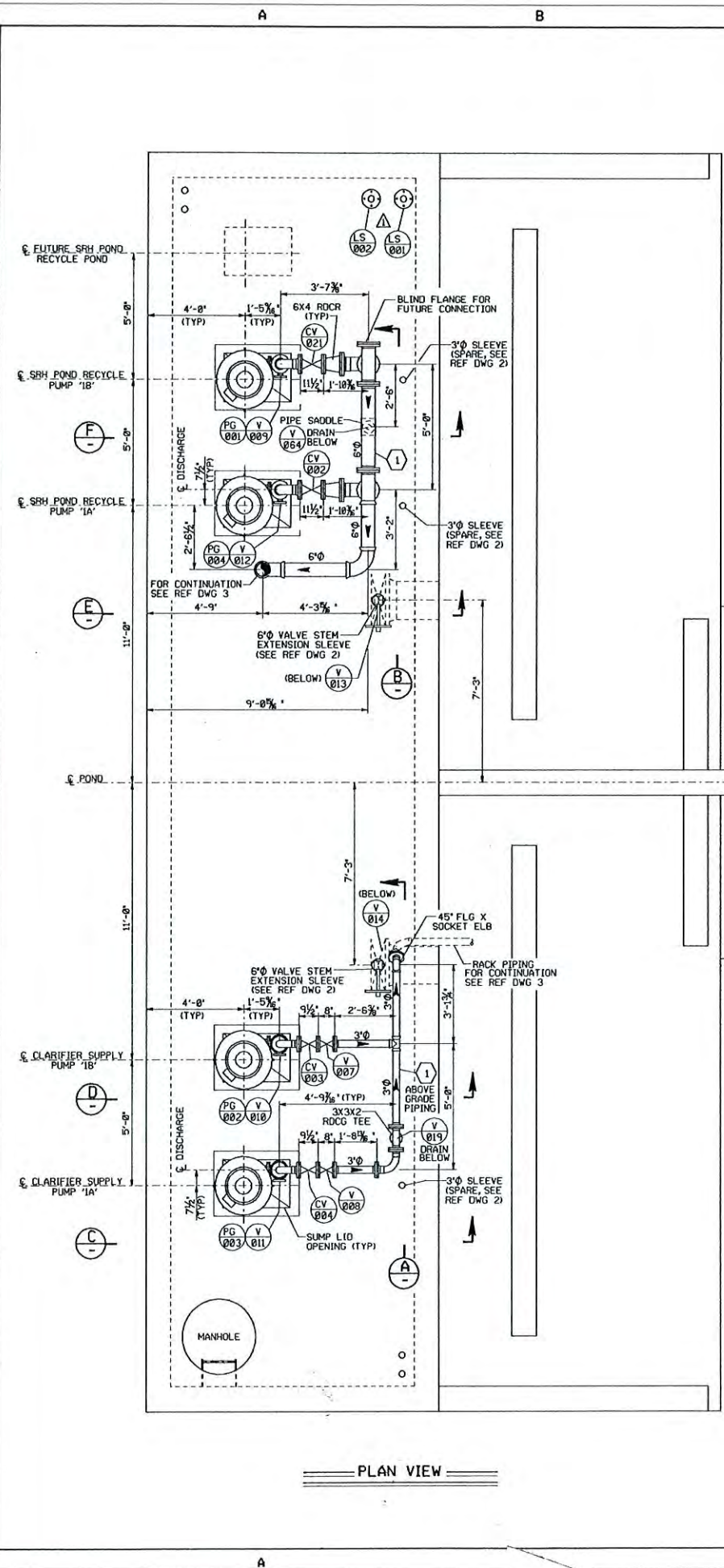

SECTION A

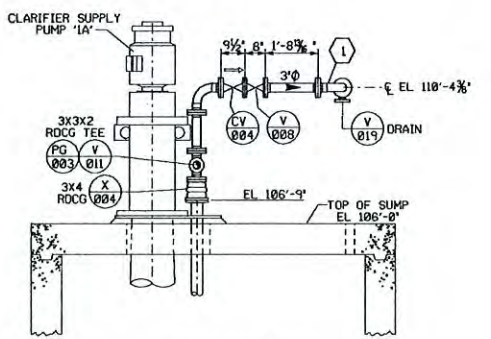

SECTION B

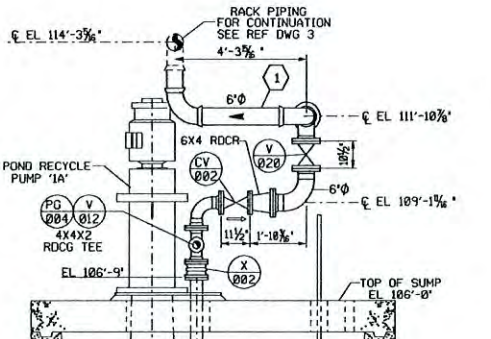

SECTION C

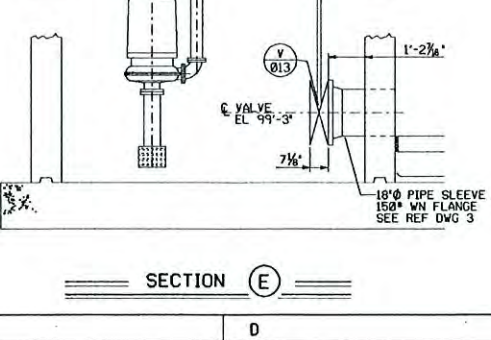

SECTION D

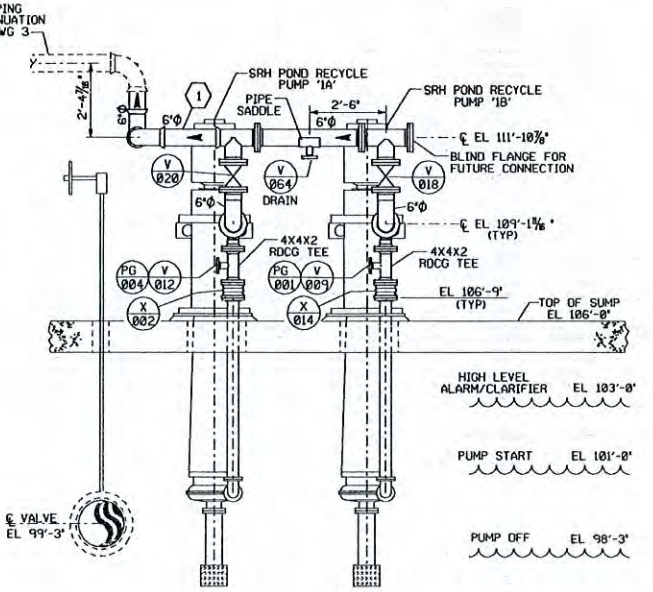

SECTION E

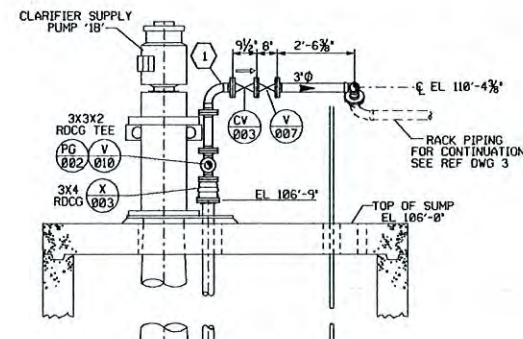

SECTION F

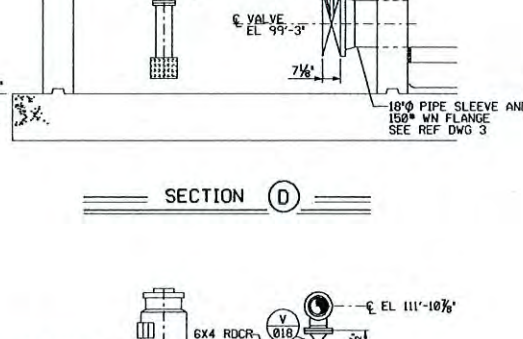

SECTION G

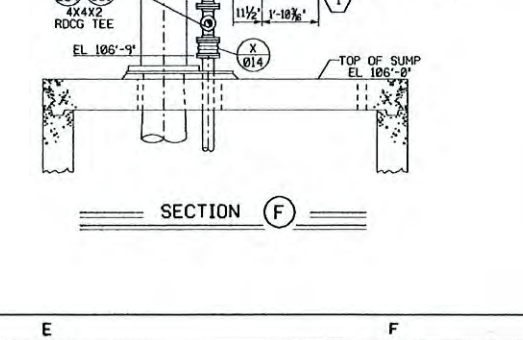

SECTION H

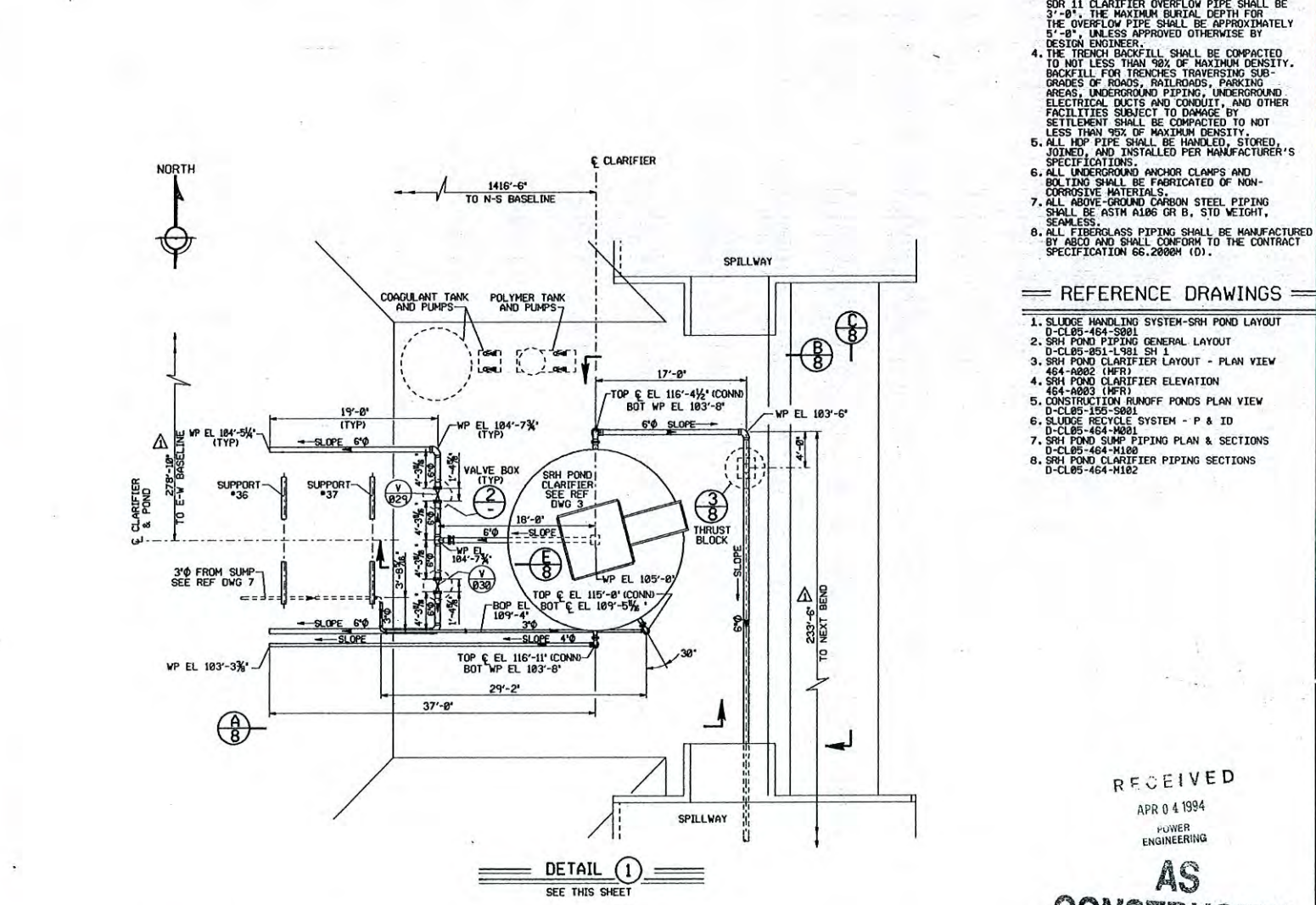
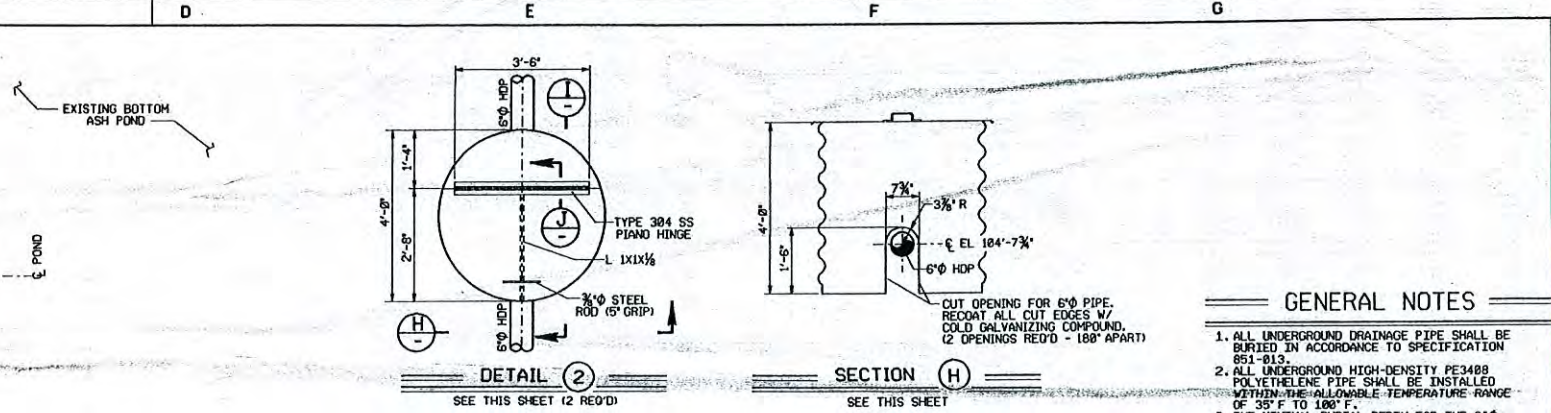
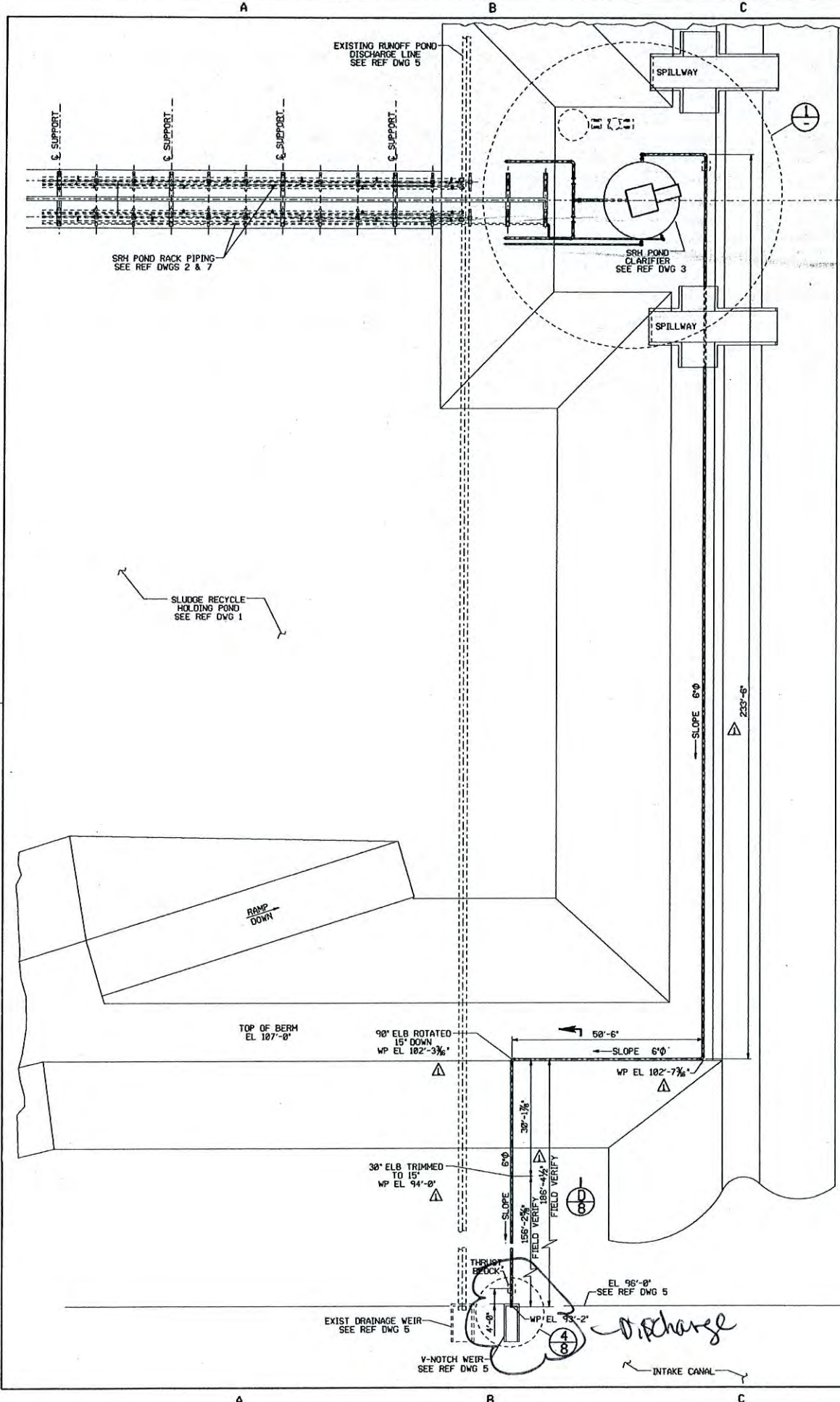

- GENERAL NOTES**
1. ALL UNDERGROUND DRAINAGE PIPE SHALL BE BURIED IN ACCORDANCE TO SPECIFICATION 651-013.
 2. ALL UNDERGROUND HIGH-DENSITY PE3408 POLYETHYLENE PIPE SHALL BE INSTALLED WITHIN THE ALLOWABLE TEMPERATURE RANGE OF 35° F TO 100° F.
 3. THE MINIMAL BURIAL DEPTH FOR THE 6" SDR 11 CLARIFIER OVERFLOW PIPE SHALL BE 3'-8". THE MAXIMUM BURIAL DEPTH FOR THE OVERFLOW PIPE SHALL BE APPROXIMATELY 5'-8", UNLESS APPROVED OTHERWISE BY DESIGN ENGINEER.
 4. THE TRENCH BACKFILL SHALL BE COMPACTED TO NOT LESS THAN 90% OF MAXIMUM DENSITY. BACKFILL FOR TRENCHES TRAVERSING SUBGRADES OF ROADS, RAILROADS, PARKING AREAS, UNDERGROUND PIPING, UNDERGROUND ELECTRICAL DUCTS AND CONDUIT, AND OTHER FACILITIES SUBJECT TO DAMAGE BY SETTLEMENT SHALL BE COMPACTED TO NOT LESS THAN 90% OF MAXIMUM DENSITY.
 5. ALL HDPE PIPE SHALL BE HANDLED, STORED, JOINED, AND INSTALLED PER MANUFACTURER'S SPECIFICATIONS.
 6. ALL UNDERGROUND ANCHOR CLAMPS AND BOLTING SHALL BE FABRICATED OF NON-CORROSIVE MATERIALS.
 7. ALL ABOVE-GROUND CARBON STEEL PIPING SHALL BE ASTM A106 GR B, STD WEIGHT, SEAMLESS.
 8. ALL FIBERGLASS PIPING SHALL BE MANUFACTURED BY ABCO AND SHALL CONFORM TO THE CONTRACT SPECIFICATION 65.2000M (D).

- REFERENCE DRAWINGS**
1. SLUDGE HANDLING SYSTEM-SRH POND LAYOUT D-CL05-464-S001
 2. SRH POND PIPING GENERAL LAYOUT D-CL05-464-L SRH SH 1
 3. SRH POND CLARIFIER LAYOUT - PLAN VIEW 464-A002 (HFR)
 4. SRH POND CLARIFIER ELEVATION 464-A003 (HFR)
 5. CONSTRUCTION RUNOFF PONDS PLAN VIEW D-CL05-156-S001
 6. SLUDGE RECYCLE SYSTEM - P & ID D-CL05-464-M001
 7. SRH POND SUMP PIPING PLAN & SECTIONS D-CL05-464-M100
 8. SRH POND CLARIFIER PIPING SECTIONS D-CL05-464-M102

RECEIVED
APR 04 1994
POWER
ENGINEERING

**AS
CONSTRUCTED**



1	REV #2 ON PLAN SET 1	03/20/94	AL	SC
2	ISSUED FOR CONSTRUCTION			LE
NO.	REVISIONS	DATE	BY	CHK
THIS DRAWING IS THE PROPERTY OF UTILITY ENGINEERING CORPORATION. IT IS TO BE REPRODUCED OR USED TO FURNISH ANY INFORMATION FOR THE MAKING OF DRAWINGS OR INSTRUMENTS EXCEPT WHERE PROVIDED FOR BY AGREEMENT WITH SAID COMPANY.				
CITY PUBLIC SERVICE				
J. K. SPRUCE UNIT 1				
UTILITY ENGINEERING CORPORATION CONSULTING ENGINEERING, INC. IS SEPARATE COMPANY				
SLUDGE HANDLING SYSTEM				
SRH POND CLARIFIER PIPING PLAN				
DATE	REVISED	BY	CHECKED	DESIGNED
03/20/94		AL	AL	AL
D-CL05-464-M101				
MAR 05 1992				

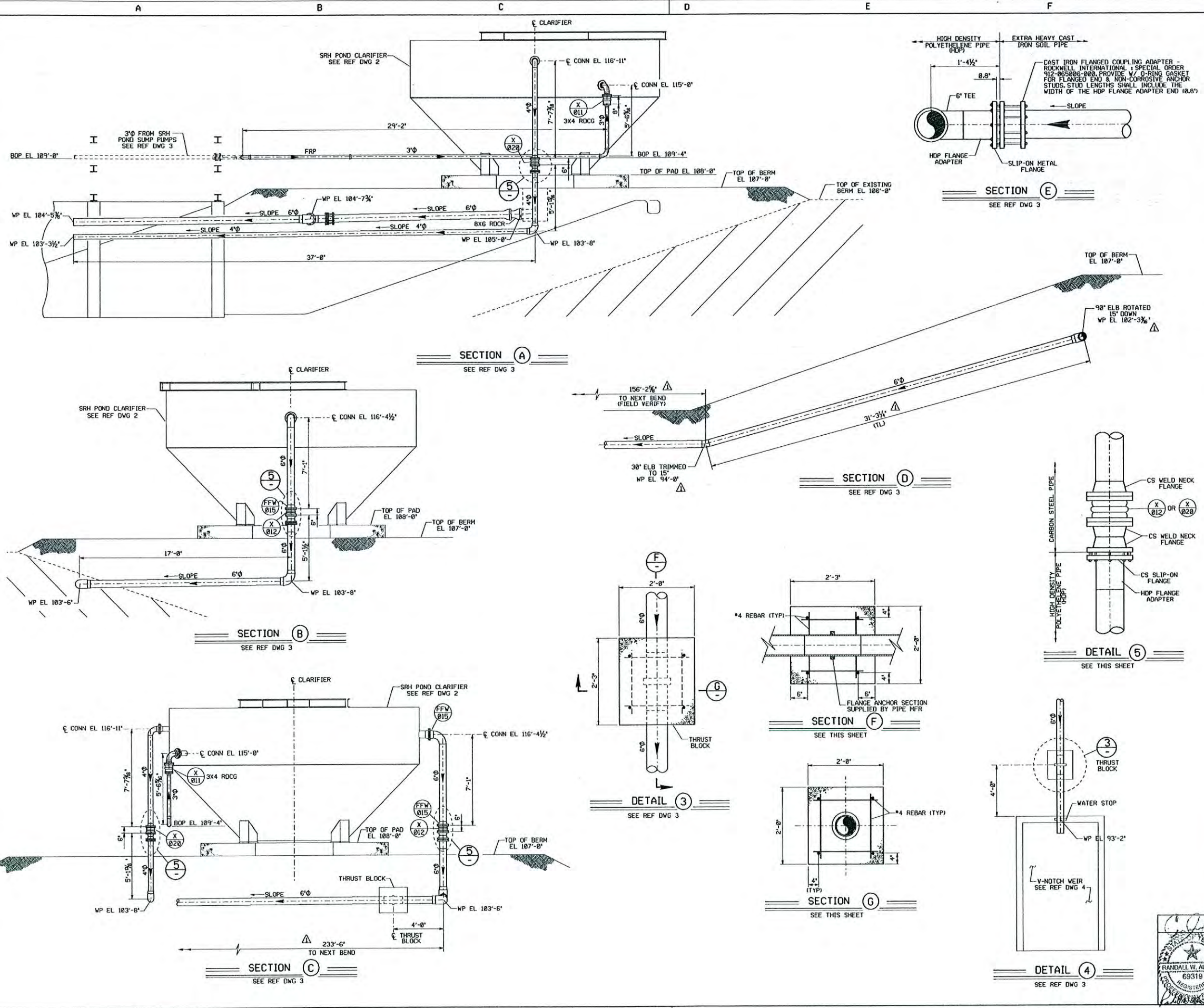

GENERAL NOTES

1. ALL UNDERGROUND DRAINAGE PIPE SHALL BE BURIED IN ACCORDANCE TO SPECIFICATION 651-013.
2. ALL UNDERGROUND HIGH-DENSITY POLYETHYLENE PIPE SHALL BE INSTALLED WITHIN THE ALLOWABLE TEMPERATURE RANGE OF 35° F TO 100° F.
3. THE MINIMAL BURIAL DEPTH FOR THE 6" Ø SRH 11 CLARIFIER OVERFLOW PIPE SHALL BE 3'-0". THE MAXIMUM BURIAL DEPTH FOR THE OVERFLOW PIPE SHALL BE APPROXIMATELY 5'-0" UNLESS APPROVED OTHERWISE BY DESIGN ENGINEER.
4. THE TRENCH BACKFILL SHALL BE COMPACTED TO NOT LESS THAN 90% OF MAXIMUM DENSITY. BACKFILL FOR TRENCHES TRAVERSING SUBGRADES OF ROADS, RAILROADS, PARKING AREAS, UNDERGROUND PIPING, UNDERGROUND ELECTRICAL DUCTS AND CONDUIT, AND OTHER FACILITIES SUBJECT TO DAMAGE BY SETTLEMENT SHALL BE COMPACTED TO NOT LESS THAN 95% OF MAXIMUM DENSITY.
5. ALL HDP PIPE SHALL BE HANDLED, STORED, JOINED, AND INSTALLED PER MANUFACTURER'S SPECIFICATIONS.
6. ALL UNDERGROUND ANCHOR CLAMPS AND BOLTING SHALL BE FABRICATED OF NON-CORROSIVE MATERIALS.
7. ALL ABOVE-GROUND CARBON STEEL PIPING SHALL BE ASTM A106 GR B, STD WEIGHT, SEAMLESS.
8. ALL FIBERGLASS PIPING SHALL BE MANUFACTURED BY ABCO AND SHALL CONFORM TO THE CONTRACT SPECIFICATION 66.2000M (D).

REFERENCE DRAWINGS

1. SLUDGE HANDLING SYSTEM-SRH POND LAYOUT D-CL05-464-5001
2. SRH POND CLARIFIER ELEVATION 464-AB03 (MFR)
3. SRH POND CLARIFIER PIPING PLAN D-CL05-464-M101
4. CONSTRUCTION RUNOFF PONDS D-CL05-155-5001

RECEIVED
 APR 04 1994
 CIVIL ENGINEERING
AS CONSTRUCTED

1	REV PIPING & SECTION C & D AS NOTED	03/29/92	WJ/SC
2	ISSUED FOR CONSTRUCTION		SC
NO.	REVISIONS	DATE	BY (SEE SIGNATURE)
THIS DRAWING IS THE PROPERTY OF UTILITY ENGINEERING CORPORATION, HANFORD, TEXAS AND IS NOT TO BE REPRODUCED OR USED IN ANY MANNER WITHOUT THE WRITTEN CONSENT OF UTILITY ENGINEERING CORPORATION. ANY REPRODUCTION OR USE WITHOUT THE WRITTEN CONSENT OF UTILITY ENGINEERING CORPORATION IS PROHIBITED.			
CITY PUBLIC SERVICE			
J. K. SPRUCE UNIT 1			
UTILITY ENGINEERING CORPORATION COMBUSTION ENGINEERING, INC. <small>AN EQUAL OPPORTUNITY COMPANY</small>			
SLUDGE HANDLING SYSTEM			
SRH POND CLARIFIER PIPING SECTIONS			
NO.	DATE	BY	CHKD
69319	03/29/92	WJ	SC
D-CL05-464-M102			
MAR 0 5 1992			



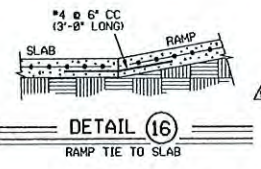
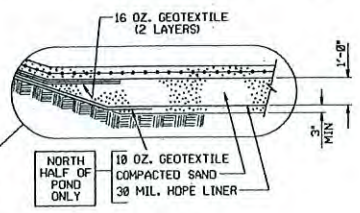
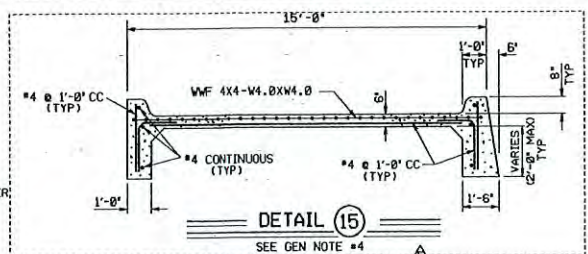
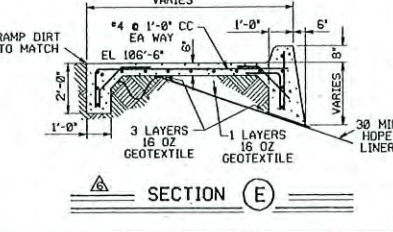
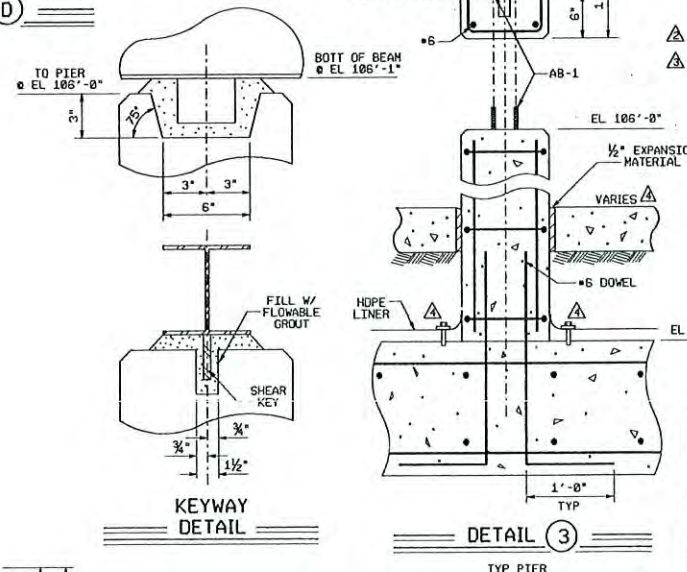
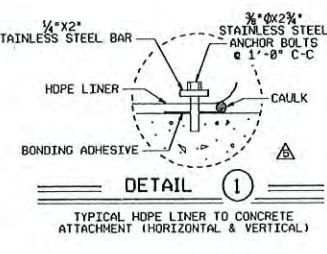
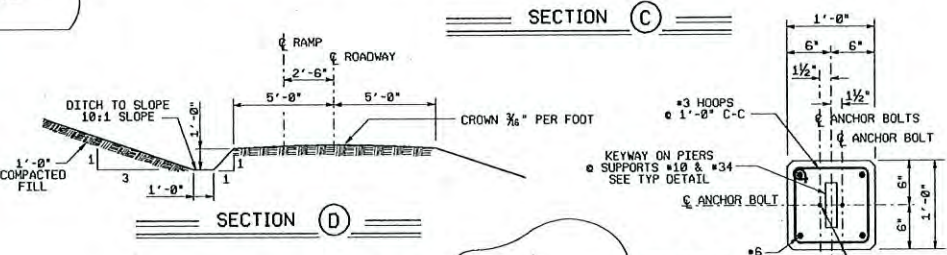
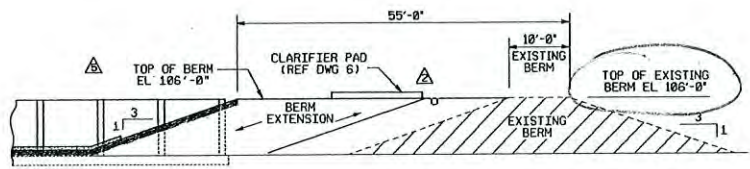
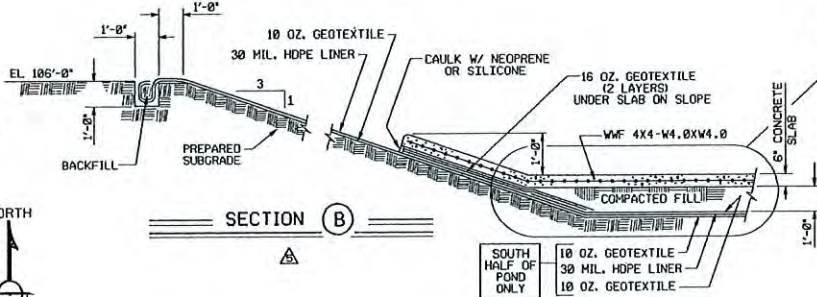
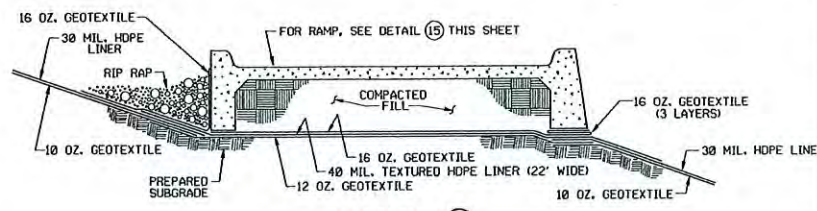
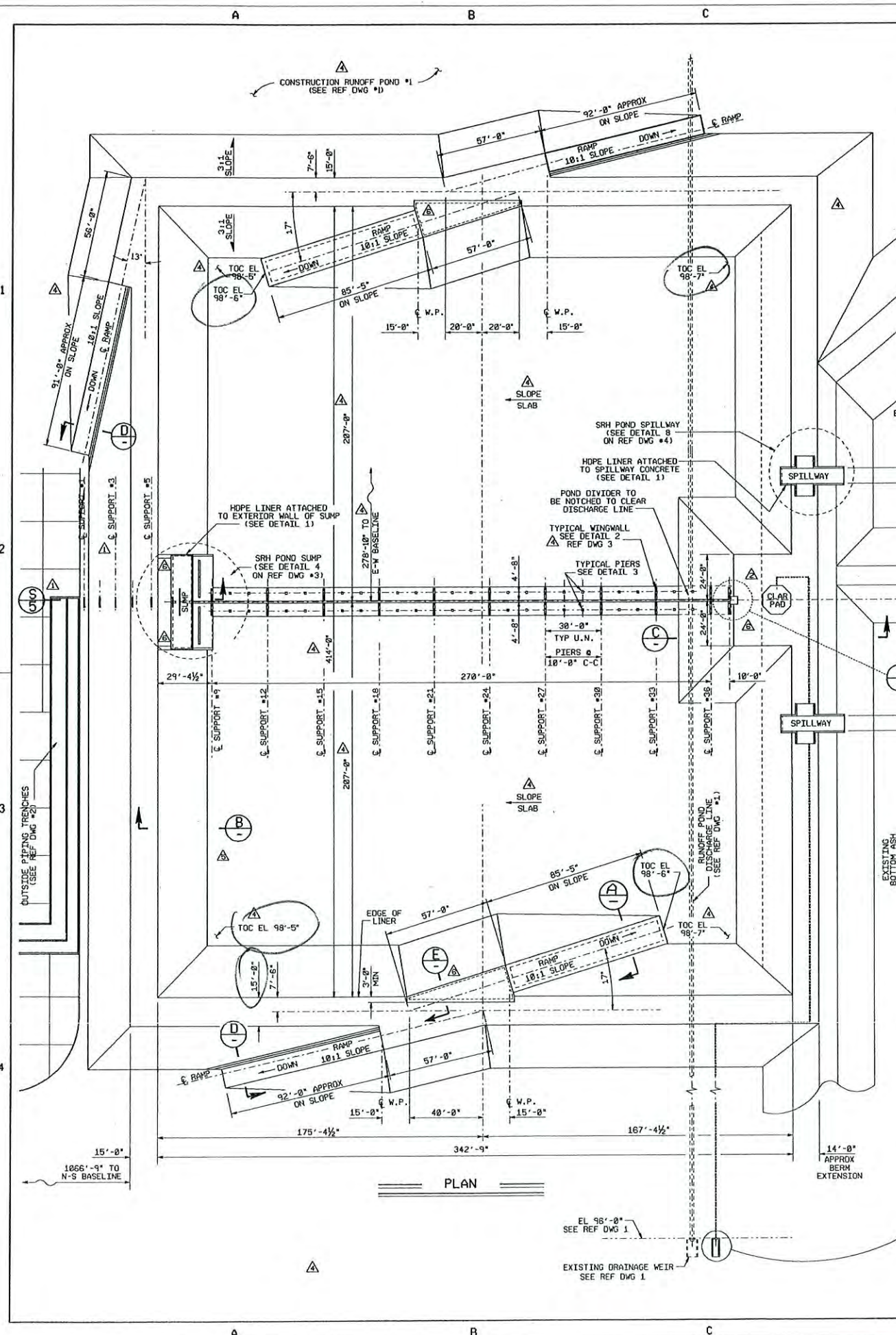

- GENERAL NOTES**
- 6" BOTTOM MAT & CONCRETE RAMPS TO HAVE CONSTRUCTION JOINTS ON 30" CENTERS TO BE LOCATED BY CONTRACTOR.
 - CONCRETE TO BE 4000 PSI (CLASS 15).
 - REINFORCING BAR TO BE GRADE 60.
 - RAMPS TO BE CONSTRUCTED WITH CONCRETE ON INSIDE OF POND ONLY. RAMPS ON EXTERIOR OF POND SHALL BE 10'-0" WIDE COMPACTED FILL.

- REFERENCE DRAWINGS**
- CONSTRUCTION RUNOFF PONDS D-CL05-155-S001
 - OUTSIDE PIPING TRENCHES (SEE REF DWG #2)
 - SRH POND SUMP - SECT & DET D-CL05-464-S002
 - SRH POND SPILLWAY - SECT & DET D-CL05-464-S003
 - SRH POND - PIPE SUPPORTS & WALKWAY D-CL05-464-S004
 - SRH POND CLARIFIER FOUNDATION D-CL05-464-S006
 - V-NOTCHED DRAINAGE WEIR D-CL05-111-S023

**AS
CONSTRUCTED**

NO.	REVISIONS	DATE	BY	CHK	APPV
6	EXTENDED RAMPS & PLAN & ADD'D SECT 'E' AS PER FM 102-28	10/22/02	JK	JAK	DK
5	ADD'D WIND WALL & SRH POND SUMP & REV'D EAST END OF PIPE TRENCH AS PER FM 102-28	07/15/02	ROD	JAK	DK
4	REV'D SPILLWAY DIMENSIONS (FM 92-363)	01/15/02	ROD	JAK	DK
3	REV'D PLAN SECT B & DET 3 AS NOTED. REV'D DETAIL 15 & 16 (FM 102-458)	01/15/02	ROD	JAK	DK
2	ADD'D V-NOTCHED DRAINAGE WEIR. ADD'D REF DWG 7 & REV'D SECT E.	11/27/01	ROD	JAK	DK
1	REV'D HOLD ON CLARIFIER PAD & PLAN. D-CL05-464-S004	09/14/01	ROD	JAK	DK
0	CUT SECTION D ON WEST BERM. REV'D REF DWG 1	08/04/01	TDC	JAK	DK
0	ISSUED FOR CONSTRUCTION				

**CITY PUBLIC SERVICE
J. K. SPRUCE UNIT 1**

UTILITY ENGINEERING CORPORATION
CONSTRUCTION ENGINEERING, INC. MEMBER COMPANY

**SLUDGE HANDLING SYSTEM
SLUDGE RECYCLE HOLDING POND**

D-CL05-464-S001

RECEIVED
APR 10 2004
POWER PLANT

DEC 3 2002

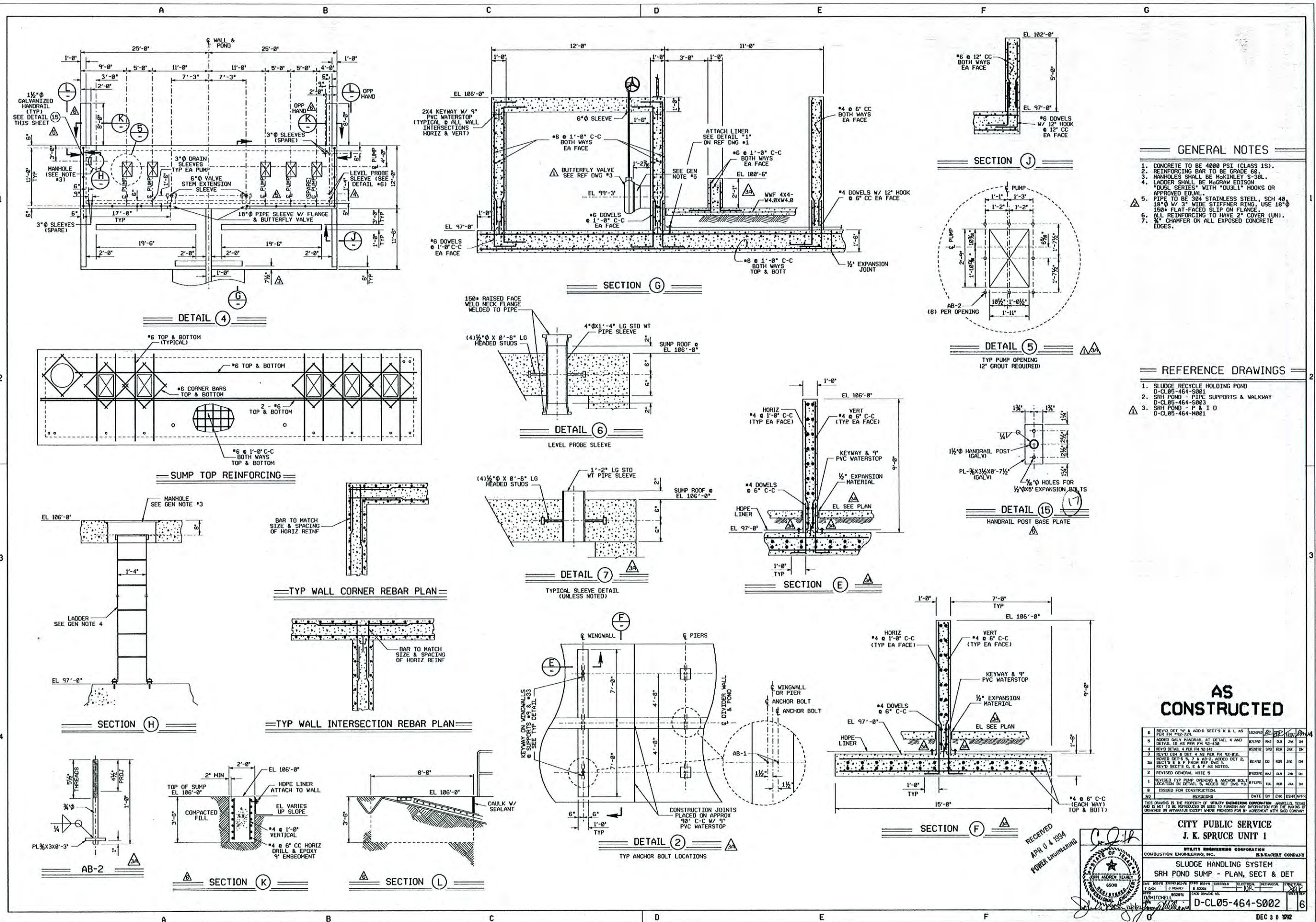

- GENERAL NOTES**
1. CONCRETE TO BE 4000 PSI (CLASS 15).
 2. REINFORCING BAR TO BE GRADE 60.
 3. HANDRAILS SHALL BE MCKINLEY 6-38L.
 4. LADDER SHALL BE McGRAW EDISON "DUBL" SERIES WITH "DUBL" HOOKS OR APPROVED EQUAL.
 5. PIPE TO BE 304 STAINLESS STEEL, SCH 40, 18" O.D. W/ 3" WIDE STIFFENER RING, USE 18" X 180" FLAT-FACED SLEEF ON FLANGE.
 6. ALL REINFORCING TO HAVE 2" COVER (MIN).
 7. 1/4" CHAMFER ON ALL EXPOSED CONCRETE EDGES.

- REFERENCE DRAWINGS**
1. SLUDGE RECYCLE HOLDING POND
D-CL05-464-S001
 2. SRH POND - PIPE SUPPORTS & WALKWAY
D-CL05-464-S003
 3. SRH POND - P & I D
D-CL05-464-M001

AS CONSTRUCTED

REV'D DET 10 & ADD SECT'S K & L AS PER FR 10-12-10	10/20/10	DP	10/20/10	10/20/10
5. ADD GALV HANDRAIL AT DETAIL 4 AND DETAIL 15 AS PER FR 10-12-10	10/13/10	DA	10/13/10	10/13/10
4. REV'D DET 4 FOR FR 10-12-10	10/12/10	DPO	10/12/10	10/12/10
3. REV'D GEN & DET 4 AS PER FR 10-12-10	10/12/10	DA	10/12/10	10/12/10
2A. REV'D DET 5, 7, & AB-2, ADD DET 2, SECT'S E, & AS NOTED.	10/12/10	DA	10/12/10	10/12/10
2. REV'D SECT'S G, E & AS NOTED.	10/20/10	DA	10/20/10	10/20/10
1. REVISED TYP PUMP OPENING & ANCHOR BOLT LOCATION IN DETAIL 5, ADD REF DWG #3.	10/12/10	DA	10/12/10	10/12/10
ISSUED FOR CONSTRUCTION.				
DATE BY	CHK	APP'D		

THIS DRAWING IS THE PROPERTY OF UTILITY ENGINEERING CORPORATION, AMARILLO, TEXAS AND IS NOT TO BE REPRODUCED OR USED TO FURNISH ANY INFORMATION FOR THE MAKING OF DRAWINGS OR SPECIFICATIONS EXCEPT AS PROVIDED FOR BY AGREEMENT WITH SAID COMPANY.

**CITY PUBLIC SERVICE
J. K. SPRUCE UNIT 1**

UTILITY ENGINEERING CORPORATION
COMBUSTION ENGINEERING, INC. ENGINEERING COMPANY

**SLUDGE HANDLING SYSTEM
SRH POND SUMP - PLAN, SECT & DET**

DATE	10/20/10	BY	DP
DATE	10/13/10	BY	DA
DATE	10/12/10	BY	DA
DATE	10/12/10	BY	DA
DATE	10/12/10	BY	DA

D-CL05-464-S002

RECEIVED
APR 04 2014
POWER ENGINEERING

[Signature]

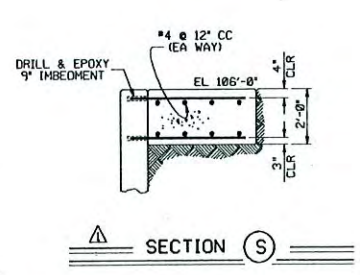
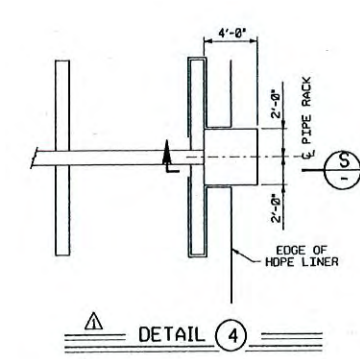
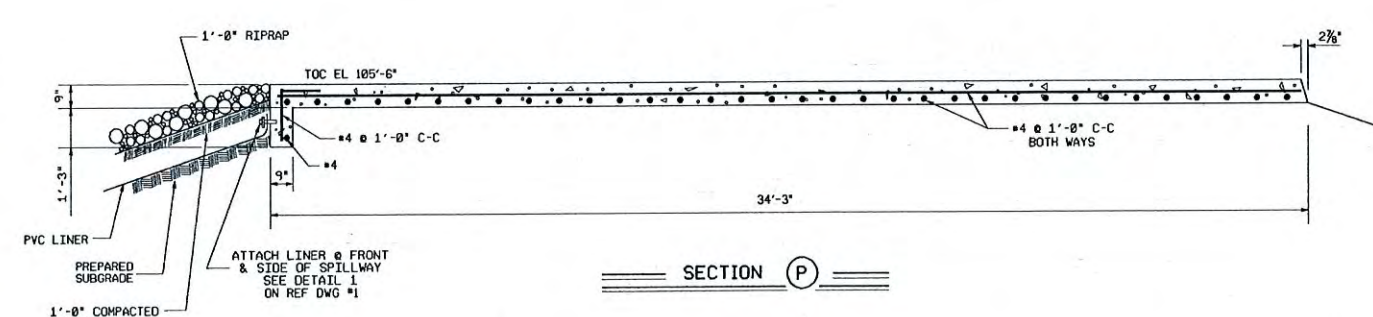
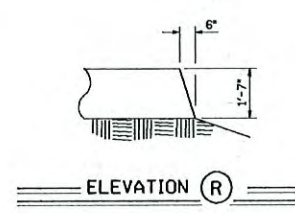
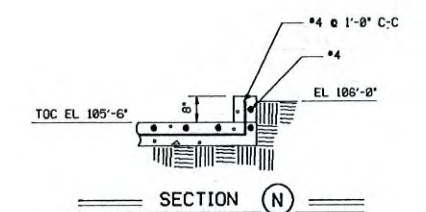
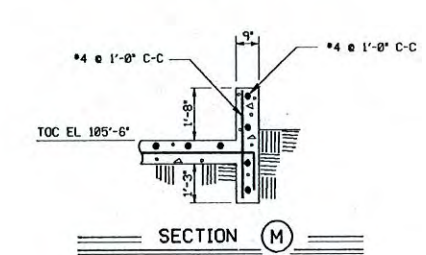
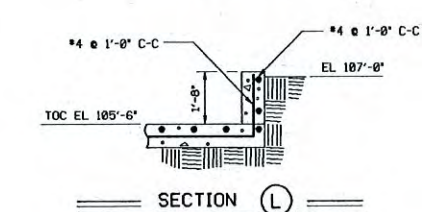
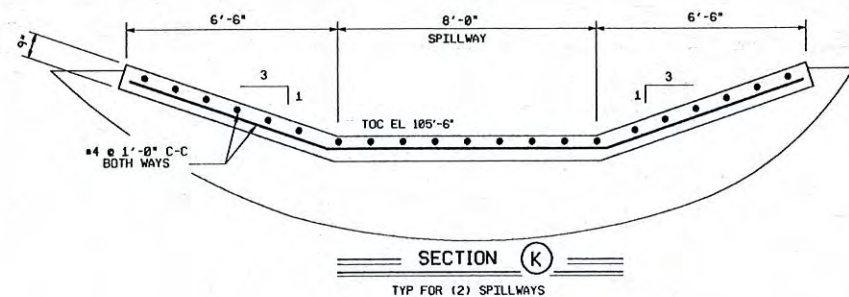
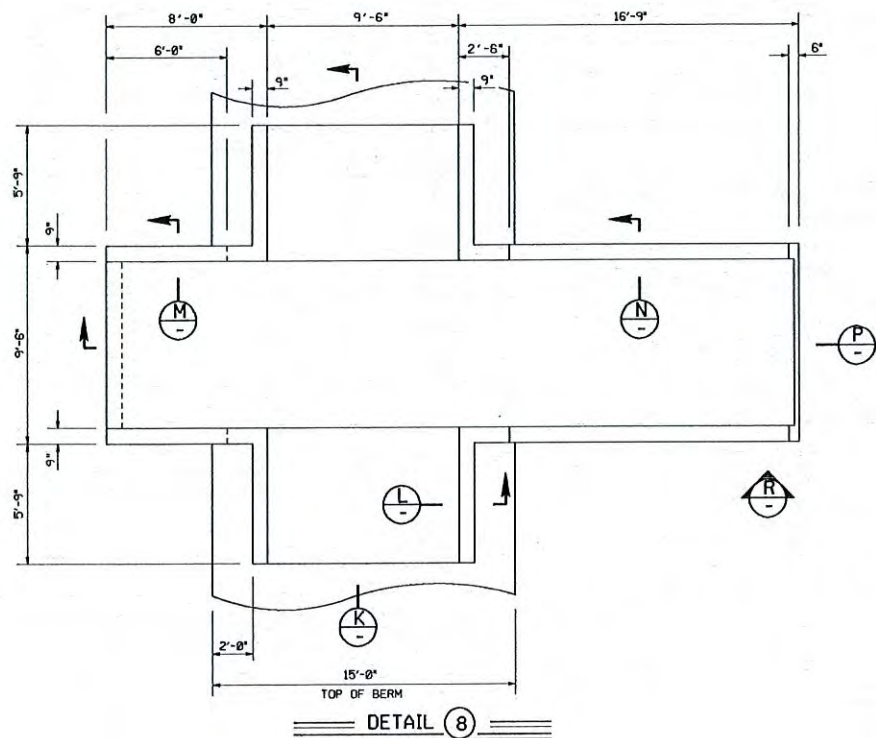

- GENERAL NOTES**
1. CONCRETE TO BE 4000 PSI (CLASS 1S).
 2. REINFORCING BAR TO BE GRADE 60.
 3. CHAMFER ON ALL EXPOSED CONCRETE EDGES.

- REFERENCE DRAWINGS**
1. SLUDGE RECYCLE HOLDING POND
D-CL05-464-S001
 2. SRH POND SUMP - SECT & DET
D-CL05-464-S002
 3. SRH POND - PIPE SUPPORTS & WALKWAY
D-CL05-464-S004

**AS
CONSTRUCTED**

RECEIVED
APR 04 1984
POWER ENGINEERING



1	ADD'D DET. "4" & SECT "S" AS PER PWT #42-52-L	10-20-83	SC	JP	DR
2	ISSUED FOR CONSTRUCTION				
NO	REVISIONS	DATE	BY	CHK	APP'D
THIS DRAWING IS THE PROPERTY OF UTILITY ENGINEERING CORPORATION, AN IRVING, TEXAS COMPANY. IT IS NOT TO BE REPRODUCED OR USED TO PROMOTE AND INFORMATION FOR THE MAKING OF DRAWINGS OR APPARATUS EXCEPT WHERE PROVIDED FOR BY AGREEMENT WITH SAID COMPANY.					
CITY PUBLIC SERVICE J. K. SPRUCE UNIT 1					
UTILITY ENGINEERING CORPORATION COMBUSTION ENGINEERING, INC. <small>AN IRVING COMPANY</small>					
SLUDGE HANDLING SYSTEM SRH POND SPILLWAY - SECT & DET					
DR	DESIGN	CHKD	CONTROL	ELC	INSTR
BY	J. K. SPRUCE	BY	J. K. SPRUCE	DATE	10-20-83
PROJECT NO. D-CL05-464-S003					1

DEC 30 1982

00
84-NV-1982 15-14
EPA/600/8-82/141A/500-1100a

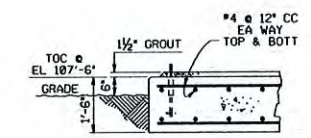
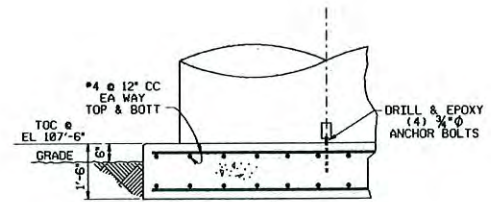
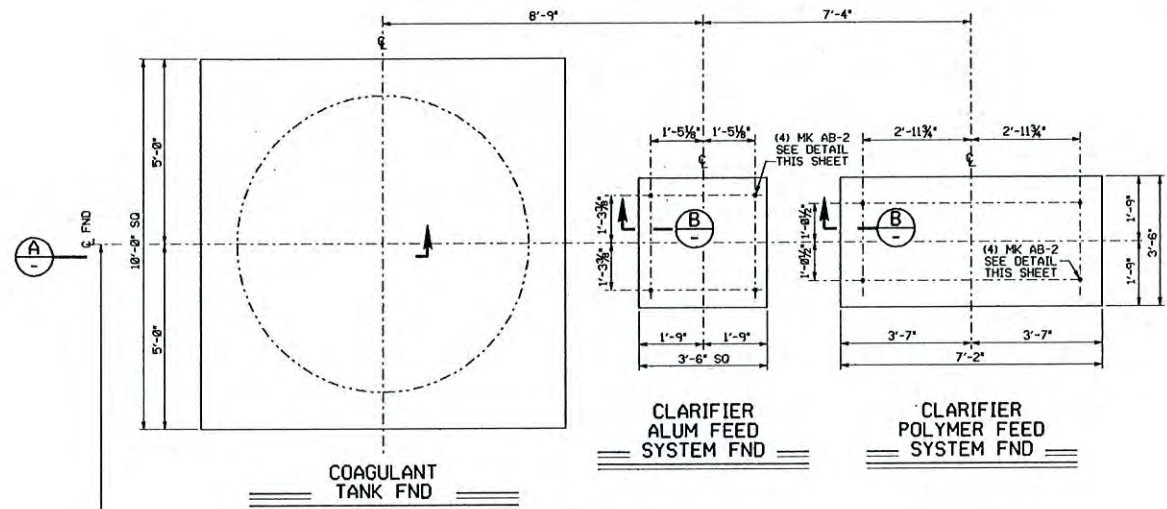

- GENERAL NOTES**
1. PROJECTING FLANGE OF EMBEDDED CHANNEL MUST BE LEVEL WITHIN 1/8".
 2. INSIDE RADIUS OF EMBEDDED CHANNEL MUST BE HELD WITHIN 1/8".
 3. CONCRETE TO BE 4800 PSI.
 4. REBAR TO BE GRADE 60.
 5. 1/4" CHAMFER REQUIRED ON ALL EXPOSED EXTERIOR CORNERS.
 6. ALL REINFORCING TO HAVE 3" COVER (MIN).

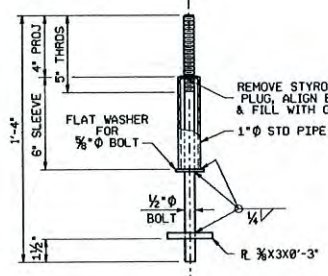
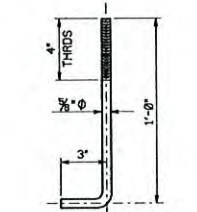
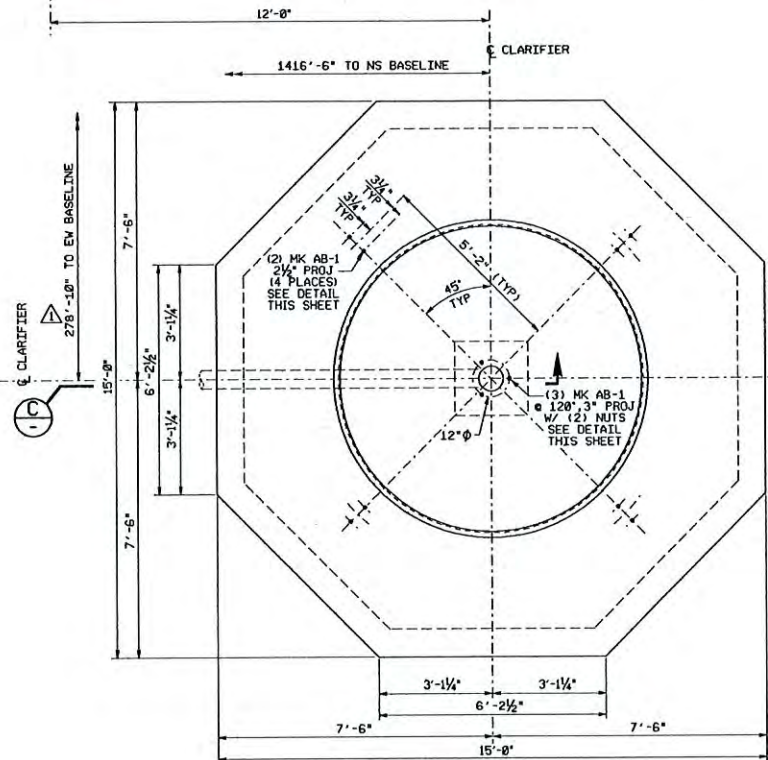

- REFERENCE DRAWINGS**
1. S.R.H. POND CLARIFIER PIPING PLAN
 2. D-CL05-464-M101
 3. SLUDGE RECYCLE HOLDING POND
 4. D-CL05-464-S001
 5. COAGULANT TANK
 6. 289-T001
 7. POLYMER FEED SYSTEM
 8. 464-A005 (MFR)

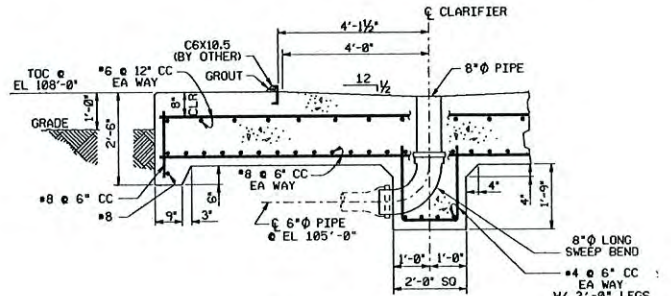

AS CONSTRUCTED

RECEIVED
APR 0 4 1994
POWER ENGINEERING

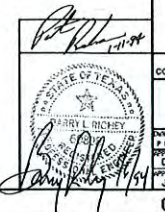

1	REV'D BY	*SRH POND CLARIFIER FND	01-01-93	01	AK/DP
2	ISSUED FOR CONSTRUCTION				
3	REVISIONS				
THIS DRAWING IS THE PROPERTY OF UTILITY ENGINEERING CORPORATION, AMARILLO, TEXAS. IT IS NOT TO BE REPRODUCED OR USED TO FURNISH ANY INFORMATION FOR THE MAKEUP OF DRAWINGS OR APPARATUS EXCEPT WHERE PROVIDED FOR BY AGREEMENT WITH SAID COMPANY.					
CITY PUBLIC SERVICE					
J. K. SPRUCE UNIT 1					
UTILITY ENGINEERING CORPORATION COMBUSTION ENGINEERING, INC. M.E. SACKETT COMPANY					
SLUDGE HANDLING SYSTEM					
CLARIFIER FND, PLAN, SEC & DET					
DATE	BY	CHECKED	DESIGNED	DRAWN	SCALE
01-01-93	J. MITCHELL	J. MITCHELL	J. MITCHELL	J. MITCHELL	AS SHOWN
PROJECT NO. D-CL05-464-S006					SHEET NO. 1
DRAWN BY J. MITCHELL					TOTAL SHEETS 1
JAN 1 0 1994					

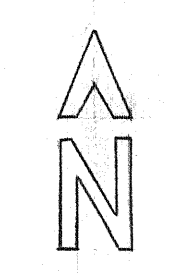
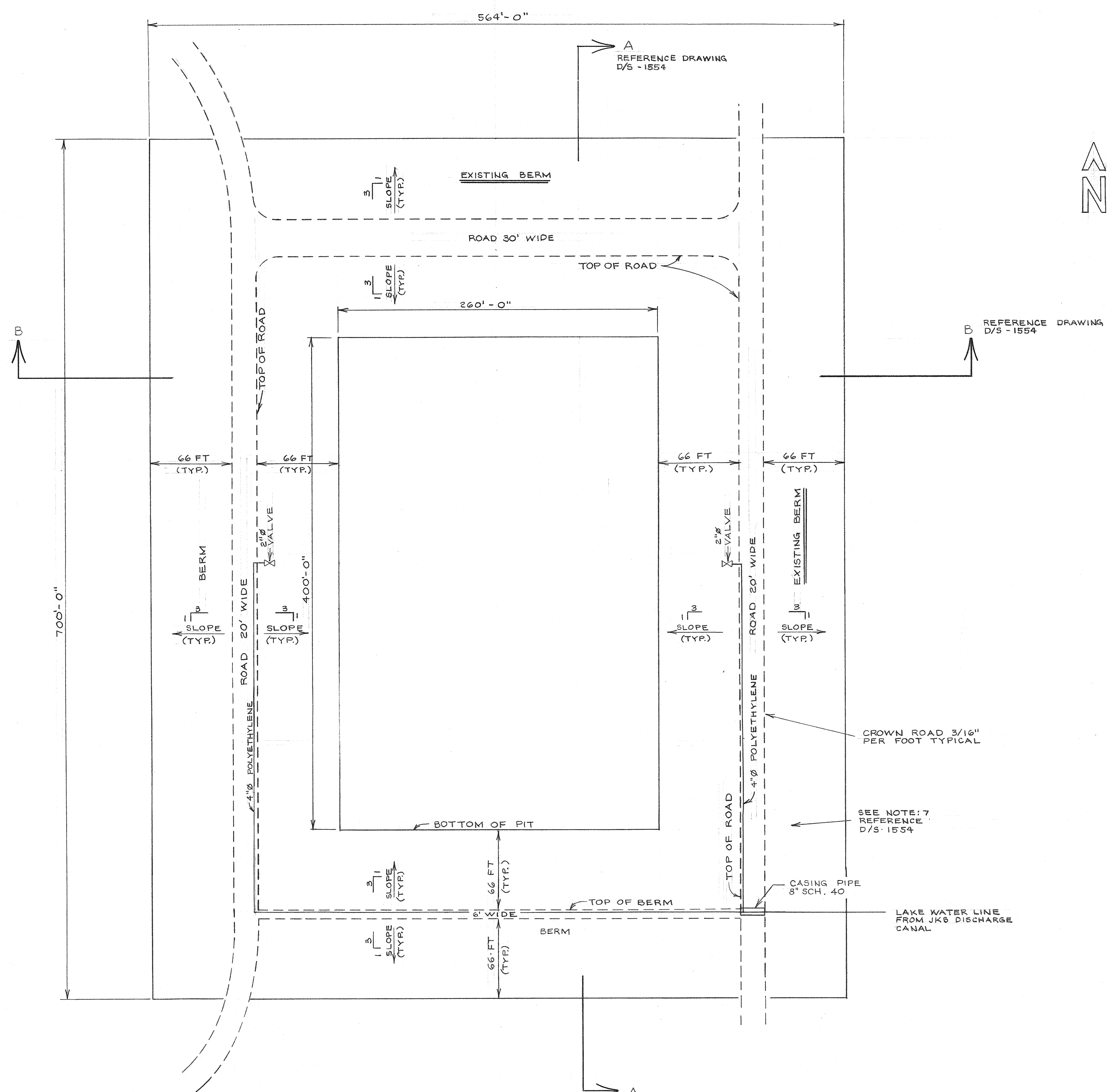

REFERENCE DRAWINGS
 1. D-CLOS-289-S002
 2. D/S 1554

CROWN ROAD 3/16" PER FOOT TYPICAL

SEE NOTE: 7 REFERENCE D/S 1554

CASING PIPE 8" SCH. 40

LAKE WATER LINE FROM JKS DISCHARGE CANAL

JT. DEELY/J.K. SPRUCE
 ASH DISPOSAL PIT # 4
 PLAN VIEW

CITY PUBLIC SERVICE
 SAN ANTONIO, TEXAS

DRAWN: FRANK TOBAR DATE: 7/16/90
 CHECKED: DTS SCALE: 1" = 50'-0"
 APPROVED: DTS SHEET 1 OF 1

No.	DATE	REVISION	BY	CK'D	APP	SYSTEM	I.D.	DRAWING NUMBER	CODE
1	7-25-90	BID ISSUE	FT.	DEE	DTS			D/S - 1547	

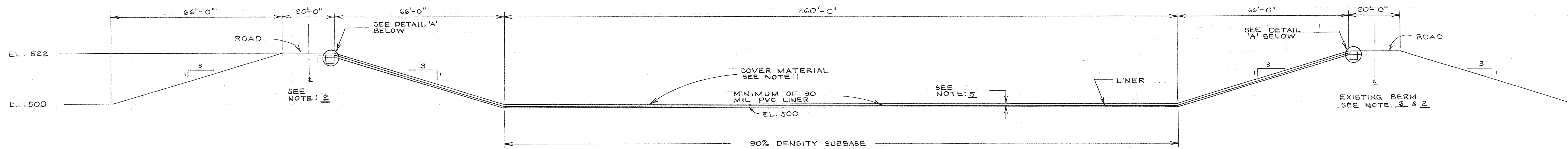

SECTION 'B-B'
— LOOKING NORTH —
SCALE: 1" = 20'-0"

REFERENCE DRAWINGS
1. D-CLOS-289-S002
2. D/S-1547

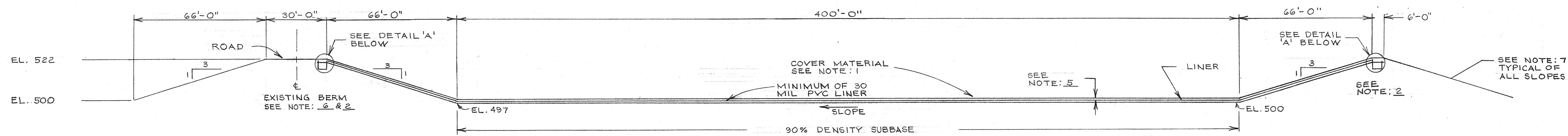

SECTION 'A-A'
— LOOKING EAST —
SCALE: 1" = 30'-0"

- NOTE:
- COVER MATERIAL SHALL BE COHESIVE SOILS FREE OF ALL ROCKS, ROOTS AND OTHER FOREIGN MATERIALS. THE COVER MATERIALS SHALL BE PLACED OVER THE LINER AS RECOMMENDED BY THE MANUFACTURER AND APPROVED BY CPS FIELD REPRESENTATIVE.
 - SUBGRADE COMPACTED TO 90% DENSITY
 - ROCKS THAT ARE LESS THAN 6" X 12" ARE ACCEPTABLE IN ALL BUT THE TOP TWO FEET OF THE BERM.
 - CONTRACTOR WILL BE REQUIRED TO WATER ALL EXTERNAL SLOPES FOR A PERIOD OF TWO MONTHS (DAILY) TO AID IN THE ESTABLISHMENT OF GRASS
 - REQUIREMENTS FOR SOIL COVER MATERIAL
 - PVC - 1 FT. OF THE TYPE OF SOIL STATED IN NOTE #1
 - HDPE - 4 IN. OF THE TYPE OF SOIL STATED IN NOTE #1
 - MOST OF THIS BERM IS EXISTING. THE CONTRACTOR WILL BE REQUIRED TO COMPLETE THE INSIDE SLOPES AND TO BRING THE EXISTING ROAD UP TO ELEVATION 522.
 - MIRAMAT "2400" OR TENSAR "NS3000" EROSION CONTROL AND REVEGETATION MAT SHALL BE INSTALLED ON EXTERNAL SLOPES, PER MANUFACTURE RECOMMENDATION. EROSION CONTROL MAT IS TO BE SUPPLIED AND INSTALLED BY CONTRACTOR. MAT IS TO BE COVER WITH A MINIMUM OF 1" OF TOP SOIL. ALL EXTERNAL SLOPES SHALL THEN BE SEED, FERTILIZED AND MULCHED BY CONTRACTOR PER SPECIFICATIONS.

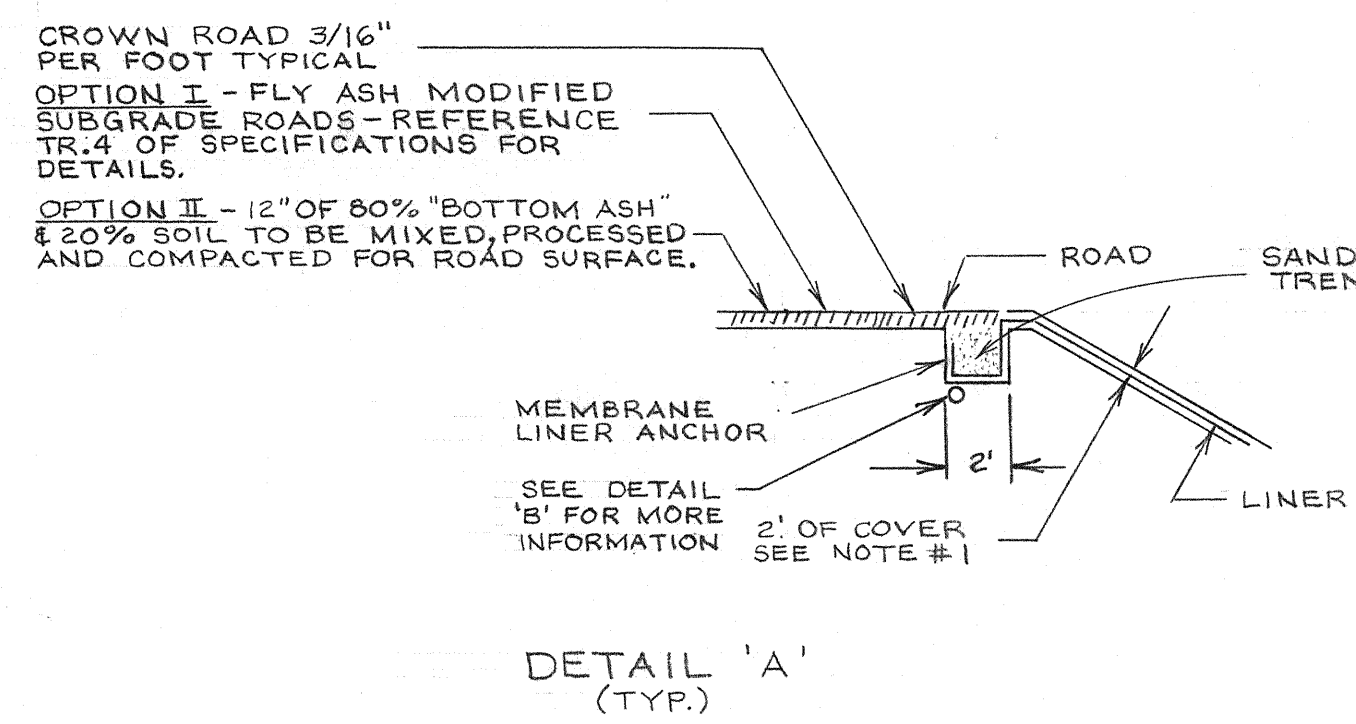

DETAIL 'A'
(TYP.)

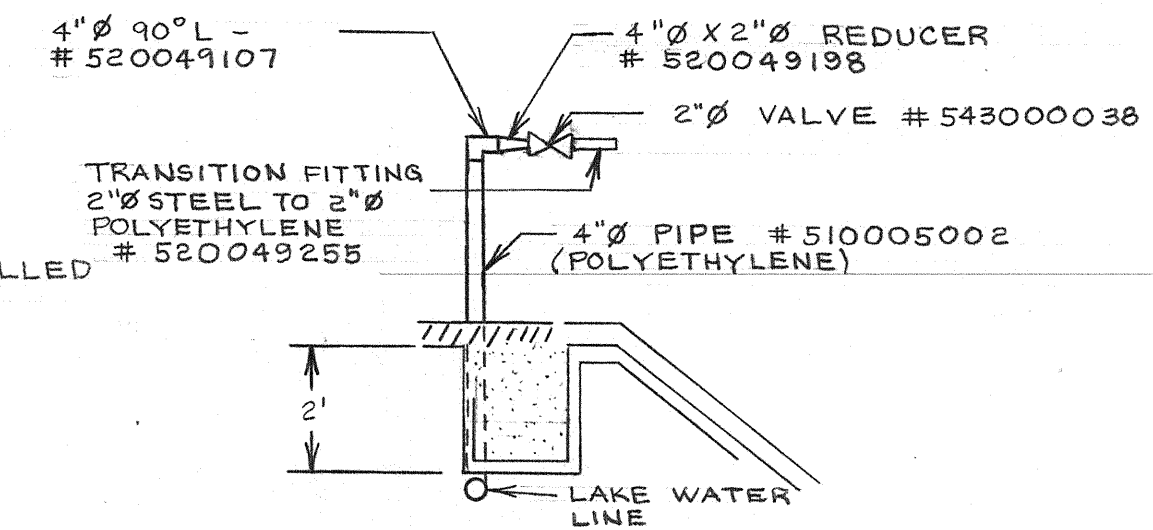

NOTE: ALL PHILLIPS DRISCO POLYETHYLENE PIPE AND ACCESSORIES WILL BE FURNISHED FROM CPS STOCK AND INSTALLED THE CONTRACTOR.

DETAIL 'B'
(TYP.)

J.T. DEELY / J.K. SPRUCE
ASH DISPOSAL PIT # 4
ELEVATION VIEWS

CITY PUBLIC SERVICE SAN ANTONIO, TEXAS			
DRAWN: FRANK TOBAR	DATE: 7/16/90		
CHECKED: DTS	SCALE: SHOWN		
APPROVED: DTS	SHEET 1 OF 1		
No.	DATE	REVISION	BY
1	7-25-90	BID ISSUE	FT. DTS DTS
			CK'D APP
SYSTEM	I.D.	DRAWING NUMBER	CODE
		D/S - 1554	

1	7-25-90	BID ISSUE	FT.	DTS	DTS	SYSTEM	I.D.	DRAWING NUMBER	CODE
No.	DATE	REVISION	BY	CK'D	APP			D/S - 1554	

CITY PUBLIC SERVICE
SAN ANTONIO, TEXAS
CALAVERAS UNIT 5

**TURNKEY CONTRACT
DOCUMENTS**

VOLUME 4

**POWER PLANT EQUIPMENT
AND MATERIAL REQUIREMENTS**

BOOK 1

**DIV 50 - UNIT DESIGN AND PERFORMANCE
DIV 60 - GENERAL
DIV 61 - STRUCTURAL**

DEC 31 1987

**UTILITY ENGINEERING CORPORATION
H. B. ZACHRY COMPANY
COMBUSTION ENGINEERING, INC.**

Section 50.0200 - SITE DESIGN CONDITIONS

1.0 GENERAL. The Calaveras Unit 5 site conditions to be used as design and performance criteria shall be as described herein. These site design conditions shall be used for the design and selection of any equipment or materials furnished unless otherwise stated.

2.0 METEOROLOGY. The climate in the vicinity of the Calaveras Lake site is characteristic of the plains of south Texas. The site ambient conditions are summarized as follows.

Elevation	494 ft msl
Design ambient temperature	110 F maximum 0 F minimum
Dry- and wet-bulb temperature and duration	
Recorded dry-bulb (December - February)	99 percent of time above 25 F 97.5 percent of time above 30 F
Recorded dry-bulb and mean coincident wet- bulb (June - September)	1 percent of time above 99 F/72 F 2.5 percent of time above 97 F/73 F 5 percent of time above 96 F/73 F
Mean daily range (summer)	19 F
Design wet-bulb	1 percent of time above 77 F 2.5 percent of time above 76 F 5 percent of time above 76 F
Mean annual precipitation	29 inches

3.0 NATURAL PHENOMENA DESIGN CRITERIA. The design criteria based on natural phenomena shall be as follows.

3.1 Rainfall. The rainfall design basis may vary for the different systems and system components. The Contractor shall identify each building, system component, and the associated rainfall design basis in the Project Outline. The Project Consultant will provide information to the Contractor regarding the Coal Yard Facilities for inclusion in the Project Outline.

Precipitation amounts to be used with each design basis are listed in Table 50.0200-1 included herein for various durations and return periods. The data were obtained from the Rainfall Frequency Atlas of the United States, May 1961.

3.2 Wind Speed. The design wind speed shall be 80 miles per hour based on ANSI Standard A58.1-1982 for a 50 year recurrence interval. This design wind speed shall be used to determine wind loads for all structures except the concrete chimney. The design wind speed for the concrete chimney design shall be in accordance with the requirements for the chimney included in Section 61.1001 of these contract documents.

3.3 Temperature. Systems and system component design criteria which require ambient temperature extremes shall use the range from 0 F to 110 F for dry-bulb temperatures. Equipment such as oil-filled power transformers shall be designed for a maximum daily average temperature of 100 F.

3.4 Relative Humidity. The average annual relative humidity is 67 percent.

3.5 Barometric Pressure. The average annual barometric pressure is 29.49 inches Hg abs based on a site elevation of 494 feet above mean sea level.

3.6 Frost Depth. The "mean air freezing index" at the Calaveras Lake site is 0 degree-days. The index is defined as the cumulative number of degree-days below 32 F computed on the basis of mean air temperature data.

The "design freezing index" is 50 degree-days. This index is defined as the cumulative number of degree-days with air temperature below 32 F for the coldest year in a 10 year cycle, or the average of the coldest 3 years in a 30 year cycle. (The above information was extracted from the Army Technical Manual TM5-818-2, Pavement Design for Frost Conditions, July 1965.)

The relationship between air freezing index and frost penetration for various types of soils and surface cover is shown on Figure 50.0200-1 included herein, as extracted from the Army Technical Manual TM5-852-6, January 1966.

Frost protection for footings, pipes, and other frost susceptible structures shall be designed according to the above criteria; however, unless special localized conditions exist, 2 feet shall be used for frost penetration design.

Yard fire water mains shall be installed with top of pipe not less than 1 foot below the design frost penetration depth in accordance with National Fire Protection Association Standard 24.

TABLE 50.0200-1. PRECIPITATION AMOUNTS FOR SELECTED DURATIONS AND RETURN PERIODS EXPECTED IN THE CALAVERAS LAKE SITE AREA

<u>Duration</u> hours	<u>Return Period</u>				
	<u>5 Year</u> inches	<u>10 Year</u> inches	<u>25 Year</u> inches	<u>50 Year</u> inches	<u>100 Year</u> inches
1/2	1.95	2.32	2.68	3.02	3.35
1	2.44	2.92	3.38	3.80	4.25
2	3.03	3.58	4.21	4.69	5.29
3	3.33	3.97	4.63	5.25	5.86
6	4.00	4.77	5.67	6.29	7.13
12	4.75	5.63	6.68	7.64	8.54
24	5.41	6.60	7.75	8.80	9.92

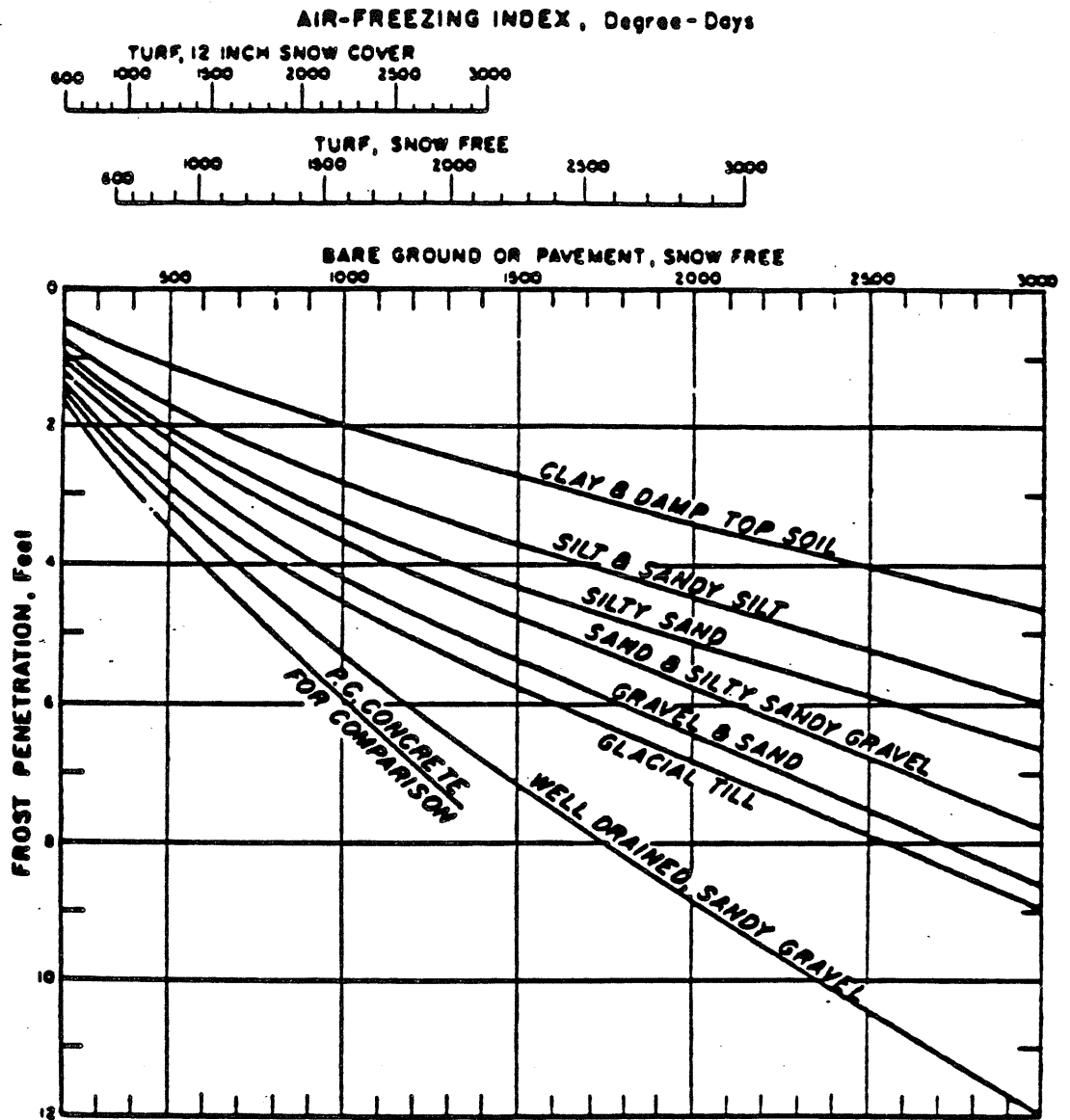

Relationship between air-freezing index, surface cover, and frost penetration into homogeneous soils

FIGURE 50.0200-1

3.7 Seismicity. The Calaveras Lake site is located in Risk Zone 0, as determined from Figure 13 of ANSI Standard A58.1-1982.

3.8 Soil Resistivity. An onsite soil resistivity survey shall be performed by the Contractor. Information regarding soil resistivity is required for design of the station grounding system and to determine the requirements for cathodic protection of underground piping. The results of the survey shall be documented in the Project Outline to be provided by the Contractor as described in Volume 2.

3.9 Soil Borings. The Contractor shall be responsible for all soil borings and geotechnical analysis of soil borings. Any soil boring information provided by the Owner is for the Contractor's information only. Information regarding soil borings and their effect on design of the power plant systems shall be documented in the Project Outline to be provided by the Contractor as described in Volume 2.

4.0 DESIGN WATER QUALITY. The water supplies to the Calaveras Lake site are from the lake and from a city water main.

4.1 Lake Water. The design water quality to be used for all equipment, materials, and processes using untreated lake water shall be as follows.

<u>Constituent</u>	<u>Design Value</u>	<u>Typical Range</u>
Calcium, mg/l as CaCO ₃	120	100 - 135
Magnesium, mg/l as CaCO ₃	107	95 - 115
Sodium, mg/l as CaCO ₃	182	85 - 230
Potassium, mg/l as CaCO ₃	24	20 - 27
Alkalinity, mg/l as CaCO ₃	156	140 - 180
Sulfate, mg/l as CaCO ₃	111	95 - 120
Chloride, mg/l as CaCO ₃	166	35 - 225
Silica, mg/l as SiO ₂	0.3	0.1 - 0.5
Iron, mg/l as Fe	0.14	0.07 - 0.22
pH	8.8	7.3 - 9.1
Conductivity, mmho/cm	847	820 - 875

Lake water temperature for design and performance guarantees shall be 95 F.

4.2 City Water. The design water quality to be used for all equipment, materials, and processes using city water shall be as follows.

<u>Constituent</u>	<u>Design Value</u>	<u>Typical Range</u>
Calcium, mg/l as CaCO ₃	187	175 - 195
Magnesium, mg/l as CaCO ₃	59	55 - 65
Sodium, mg/l as CaCO ₃	15	10 - 20
Alkalinity, mg/l as CaCO ₃	213	200 - 225
Sulfate, mg/l as CaCO ₃	26	23 - 30
Chloride, mg/l as CaCO ₃	21	18 - 23
Nitrate, mg/l as CaCO ₃	1	1 - 2
Silica, mg/l as SiO ₂	13	10 - 15
Iron, mg/l as Fe	<0.03	-
pH	7.7	7.2 - 8.1

Appendix D

Photographs

EPA Assessment - SRH Pond Photos August 27, 2012



Photo 1: East embankment interior slope, looking north.



Photo 2: South embankment exterior slope, looking west.



Photo 3: East embankment crest, looking north.



Photo 4: East embankment interior slope, looking north.

EPA Assessment - SRH Pond Photos August 27, 2012



Photo 5: Spillway between SRH Pond and South Bottom Ash Pond at east embankment crest, looking north.



Photo 6: Spillway between SRH Pond and South Bottom Ash Pond at east embankment exterior slope, looking east.



Photo 7: Spillway between SRH Pond and South Bottom Ash Pond at east embankment interior slope, looking west.



Photo 8: SRH Pond clarifier structure at east embankment crest, looking north.

EPA Assessment - SRH Pond Photos August 27, 2012



Photo 9: Spillway between SRH Pond and South Bottom Ash Pond at east embankment crest, looking north.



Photo 10: Spillway between SRH Pond and South Bottom Ash Pond at west embankment exterior slope, looking east.



Photo 11: Spillway between SRH Pond and South Bottom Ash Pond at east embankment interior slope, looking west.



Photo 12: East embankment interior slope, looking north.

EPA Assessment - SRH Pond Photos August 27, 2012



Photo 13: North embankment crest, looking west.



Photo 14: North embankment interior slope, looking west.



Photo 15: North embankment exterior slope, looking west. #1 Stormwater Runoff Pond at exterior toe.



Photo 16: North embankment exterior slope, looking west.

EPA Assessment - SRH Pond Photos August 27, 2012



Photo 17: North embankment interior slope, looking west.



Photo 18: North embankment exterior slope, looking west.



Photo 19: West embankment interior slope, looking south.



Photo 20: East embankment crest, looking south.

EPA Assessment - SRH Pond Photos August 27, 2012



Photo 21: West embankment exterior slope, looking south.



Photo 22: West embankment exterior slope, looking south.



Photo 23: Overhead piping at west embankment crest, looking south.



Photo 24: Submerged SRH-north outlet structure at west embankment interior slope, looking south.

EPA Assessment - SRH Pond Photos August 27, 2012



Photo 25: Piping at west embankment interior slope, looking northeast.



Photo 26: 8-inch-diameter metal SRH-south inlet pipe labeled "Plant Drain System III", looking northeast.



Photo 27: Submerged SRH-south outlet structure at west embankment interior slope, looking north.



Photo 28: 6-inch-diameter metal SRH-south inlet pipe labeled "Waste Slurry Sump", looking south.

EPA Assessment - SRH Pond Photos August 27, 2012



Photo 29: Label for inlet pipe in Photo 28.



Photo 30: 6-inch-diameter metal SRH-south inlet pipe, looking south.



Photo 31: 6-inch-diameter SRH-south inlet pipe labeled "SRH Pond & Clarifier Syst 464", looking west.



Photo 32: 8-inch-diameter SRH-south inlet pipe labeled "SRH Pond & Clarifier Syst 464", looking west.

EPA Assessment - SRH Pond Photos August 27, 2012



Photo 33: 6-inch and 8-inch-diameter SRH-north inlet pipe labeled "SRH Pond & Clarifier Syst 464", looking west.



Photo 34: Nine outlet pipes into SRH-south, looking south.



Photo 35: Labels for middle three 6-inch-diameter inlets shown in Photo 34.



Photo 36: Labels for left two 6-inch-diameter inlets shown in Photo 34.

EPA Assessment - SRH Pond Photos August 27, 2012



Photo 37: Labels for right four 4-inch-diameter inlets shown in Photo 34.



Photo 38: Nine outlet pipes into SRH-north, looking north.



Photo 39: Labels for right two 6-inch-diameter inlets shown in Photo 38.



Photo 40: Labels for middle three 6-inch-diameter inlets shown in Photo 38.

EPA Assessment – SRH Pond Photos August 27, 2012



Photo 41: Labels for left four 4-inch-diameter inlets shown in Photo 38.



Photo 42: 6-inch-diameter metal SRH-north inlet pipe labeled "Waste Slurry Sump", looking north.



Photo 43: 6-inch-diameter metal SRH-north inlet pipe, looking north.



Photo 44: 8-inch-diameter metal SRH-north inlet pipe labeled "Plant Drain System III", looking southeast.

EPA Assessment - SRH Pond Photos August 27, 2012



Photo 45: West embankment interior slope, looking south.



Photo 46: West embankment exterior slope, looking south.



Photo 47: West embankment crest, looking south.



Photo 48: Interior slope at southwest corner interior slope, looking southeast.

EPA Assessment - SRH Pond Photos August 27, 2012



Photo 49: Exterior slope at southwest corner, looking southwest.



Photo 50: South embankment crest, looking east.



Photo 51: South embankment interior slope, looking east.



Photo 52: South embankment exterior slope, looking east.

EPA Assessment - SRH Pond Photos August 27, 2012



Photo 53: South embankment interior slope, looking east.



Photo 54: South embankment exterior slope, looking east.



Photo 55: V-notch weir outfall for SRH Pond.



Photo 56: V-notch weir outfall for SRH Pond.

EPA Assessment – SRH Pond Photos August 27, 2012



Photo 57: SRH outfall 109, looking south.

EPA Assessment - Evaporation Pond Photos August 28, 2012



Photo 58: East Embankment crest, looking north.



Photo 59: East embankment interior slope, looking north.



Photo 60: Loose soils on east embankment exterior slope.



Photo 61: East embankment exterior slope, looking north.

EPA Assessment - Evaporation Pond Photos August 28, 2012



Photo 62: Loose soils on east embankment exterior slope.



Photo 63: East embankment exterior toe, looking north.



Photo 64: Loose soils near east embankment exterior toe.



Photo 65: East embankment exterior slope measured approximately 4H:1V.

EPA Assessment - Evaporation Pond Photos August 28, 2012



Photo 66: North embankment exterior slope, looking west.



Photo 67: North embankment exterior slope, looking west.



Photo 68: North embankment crest, looking west.



Photo 69: North embankment interior slope, looking west.

EPA Assessment - Evaporation Pond Photos August 28, 2012



Photo 70: East embankment interior slope, looking south.



Photo 71: North embankment exterior slope, looking east.



Photo 72: North embankment exterior slope, looking east. Note trees near exterior toe.



Photo 73: Trees at north embankment exterior toe, looking east.

EPA Assessment - Evaporation Pond Photos August 28, 2012



Photo 74: West embankment interior slope, looking south.



Photo 75: West embankment exterior slope, looking south.



Photo 76: West embankment crest, looking south.



Photo 77: West embankment exterior slope, looking southwest.

EPA Assessment - Evaporation Pond Photos August 28, 2012



Photo 78: Approximately 18-inch-deep animal burrow at west embankment exterior slope.



Photo 79: West embankment interior slope, looking south.



Photo 80: West embankment exterior slope, looking south.



Photo 81: Pond signage near southwest corner.

EPA Assessment - Evaporation Pond Photos August 28, 2012



Photo 82: South embankment crest, looking east.



Photo 83: South embankment interior slope, looking east.



Photo 84: South embankment exterior slope, looking southeast.



Photo 85: Exposed soil at south embankment exterior slope, looking north.

EPA Assessment - Evaporation Pond Photos August 28, 2012



Photo 86: South embankment exterior slope measured approximately 3H:1V.



Photo 87: South embankment exterior slope, looking east.



Photo 88: South embankment interior slope, looking east.



Photo 89: South embankment exterior slope, looking east.

EPA Assessment - Evaporation Pond Photos August 28, 2012



Photo 90: Interior slope at southeast corner, looking northwest.

Appendix D Photo GPS Locations

Site: J.K. Spruce Power Plant

Datum: NAD 1983

Coordinate Units: Degrees Decimal Minutes

Photo No.	Latitude	Longitude
1	N 29 18.422'	W 98 19.040'
2	N 29 18.430'	W 98 19.044'
3	N 29 18.436'	W 98 19.048'
4	N 29 18.449'	W 98 19.046'
5	N 29 18.450'	W 98 19.044'
6	N 29 18.454'	W 98 19.044'
7	N 29 18.454'	W 98 19.043'
8	N 29 18.457'	W 98 19.046'
9	N 29 18.471'	W 98 19.044'
10	N 29 18.474'	W 98 19.043'
11	N 29 18.475'	W 98 19.044'
12	N 29 18.484'	W 98 19.045'
13	N 29 18.502'	W 98 19.049'
14	N 29 18.499'	W 98 19.048'
15	N 29 18.508'	W 98 19.052'
16	N 29 18.509'	W 98 19.065'
17	N 29 18.501'	W 98 19.079'
18	N 29 18.506'	W 98 19.109'
19	N 29 18.501'	W 98 19.109'
20	N 29 18.498'	W 98 19.110'
21	N 29 18.505'	W 98 19.114'
22	N 29 18.490'	W 98 19.115'
23	N 29 18.469'	W 98 19.113'
24	N 29 18.470'	W 98 19.104'
25	N 29 18.463'	W 98 19.109'
26	N 29 18.463'	W 98 19.106'
27	N 29 18.462'	W 98 19.105'
28	N 29 18.466'	W 98 19.080'
29	N 29 18.467'	W 98 19.080'
30	N 29 18.465'	W 98 19.077'
31	N 29 18.463'	W 98 19.052'
32	N 29 18.463'	W 98 19.052'
33	N 29 18.469'	W 98 19.053'
34	N 29 18.467'	W 98 19.058'
35	N 29 18.467'	W 98 19.058'
36	N 29 18.467'	W 98 19.058'
37	N 29 18.467'	W 98 19.058'
38	N 29 18.466'	W 98 19.058'
39	N 29 18.465'	W 98 19.058'
40	N 29 18.466'	W 98 19.058'
41	N 29 18.465'	W 98 19.058'
42	N 29 18.467'	W 98 19.075'
43	N 29 18.467'	W 98 19.075'
44	N 29 18.470'	W 98 19.107'
45	N 29 18.460'	W 98 19.109'
46	N 29 18.460'	W 98 19.113'

Appendix D Photo GPS Locations

Site: J.K. Spruce Power Plant

Datum: NAD 1983

Coordinate Units: Degrees Decimal Minutes

Photo No.	Latitude	Longitude
47	N 29 18.459'	W 98 19.111'
48	N 29 18.442'	W 98 19.110'
49	N 29 18.436'	W 98 19.113'
50	N 29 18.431'	W 98 19.107'
51	N 29 18.432'	W 98 19.106'
52	N 29 18.429'	W 98 19.109'
53	N 29 18.431'	W 98 19.079'
54	N 29 18.425'	W 98 19.070'
55	N 29 18.398'	W 98 19.055'
56	N 29 18.398'	W 98 19.054'
57	N 29 18.402'	W 98 19.056'
58	N 29 19.396'	W 98 18.843'
59	N 29 19.406'	W 98 18.848'
60	N 29 19.407'	W 98 18.835'
61	N 29 19.404'	W 98 18.836'
62	N 29 19.438'	W 98 18.839'
63	N 29 19.441'	W 98 18.829'
64	N 29 19.453'	W 98 18.831'
65	N 29 19.453'	W 98 18.836'
66	N 29 19.493'	W 98 18.852'
67	N 29 19.501'	W 98 18.850'
68	N 29 19.487'	W 98 18.852'
69	N 29 19.480'	W 98 18.858'
70	N 29 19.483'	W 98 18.858'
71	N 29 19.487'	W 98 18.948'
72	N 29 19.497'	W 98 18.923'
73	N 29 19.496'	W 98 18.909'
74	N 29 19.479'	W 98 18.928'
75	N 29 19.472'	W 98 18.938'
76	N 29 19.474'	W 98 18.932'
77	N 29 19.447'	W 98 18.932'
78	N 29 19.448'	W 98 18.937'
79	N 29 19.435'	W 98 18.923'
80	N 29 19.411'	W 98 18.926'
81	N 29 19.397'	W 98 18.919'
82	N 29 19.393'	W 98 18.909'
83	N 29 19.396'	W 98 18.910'
84	N 29 19.392'	W 98 18.906'
85	N 29 19.385'	W 98 18.907'
86	N 29 19.387'	W 98 18.906'
87	N 29 19.390'	W 98 18.891'
88	N 29 19.395'	W 98 18.882'
89	N 29 19.392'	W 98 18.870'
90	N 29 19.398'	W 98 18.847'